

Assembly Instructions

English



Grundig SAT Systems

Kopfstation STC 160 Head-End Digital Modulator 4 x COFDM

HDMH 764 T

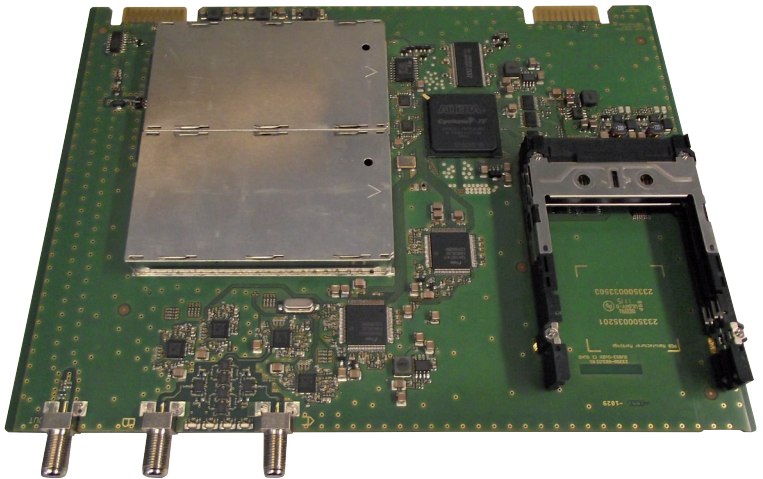

Notes on the Assembly Instructions.

As well as this supplementary Assembly Instructions, the Assembly Instructions for the STC 160 apply.



GSS
Grundig SAT Systems GmbH
Beuthener Strasse 43
D-90471 Nuremberg

Phone: +49 (0) 911 / 703 8877
Fax: +49 (0) 911 / 703 9210
Email: info@gss.de
Internet: www.gss.de/en

1	Safety regulations.....	3
2	General information	4
2.1	Scope of delivery	4
2.2	Meaning of the symbols used.....	4
2.3	Technical data.....	5
2.4	Description	6
	How the TPS module works.....	7
	Station filter.....	7
	Changing the Transport stream and ORGNET-ID	7
	Changing the NIT	7
3	Installation	7
3.1	Retrofitting a CA module	8
3.2	Installing the COFDM module	9
3.3	Connecting the COFDM module.....	10
4	The control panel at a glance	11
4.1	Functions of the control panel buttons.....	11
4.2	Menu items.....	11
5	Programming	12
5.1	Preparation.....	12
5.2	Programming procedure.....	13
5.3	Programming the COFDM module.....	16
	Selecting the module / channel strip	16
	Output settings	17
	Modulator on/off, Level	18
	Channel / Frequency	18
	COFDM parameters	20
	Output signal	23
	Transmission parameters	24
	Transmitter identification	25
	Substitute signal in the case of an incorrect input signal	26
	Input settings.....	26
	LNB oscillator frequency, Input.....	27
	Input symbol rate, DVB mode	27
	Input frequency	28
	Operation with a CA module	29
	Station filter.....	29
	PID monitoring	31
	CA module.....	32
	Economize descrambling capacity	33
	Option settings.....	34
	Transport stream ID and ORGNET-ID	34

BAT/SDT-OTHER tables	35
Deleting a PID	35
Renaming a PID	36
Output data rate	37
Network Information Table (NIT).....	37
Factory reset.....	39
Saving data.....	40
6 Final procedures.....	41
7 Channel and frequency tables.....	42

1 SAFETY REGULATIONS



- The standards EN/DIN EN 50083 resp. IEC/EN/DIN EN 60728 must be observed.
- Do not perform installation and service work during thunderstorms.
- Assembly, installation and servicing should be carried out by authorised electricians.
- Switch off the operating voltage of the system before beginning with assembly or service work.
- Avoid short circuits!
- Observe the relevant standards, regulations and guidelines on the installation and operation of antenna systems.
- To ensure electromagnetic compatibility, make sure all connections are tight and the covers are screwed on securely.
- No liability is accepted for damage caused by faulty connections or inappropriate handling of the device.



Check the head-end station STC 160 according to the safety instructions listed in their assembly instruction.



Take precautions to prevent static discharge when working on the device!



Electronic devices should never be disposed of in the household rubbish. In accordance with directive 2002/96/EC of the European Parliament and the European Council from January 27, 2003 which addresses old electronic and electrical devices, such devices must be disposed of at a designated collection facility. At the end of its service life, please take your device to one of these public collection facilities for proper disposal.

2 GENERAL INFORMATION

2.1 SCOPE OF DELIVERY

- 1 Head-end Digital Modulator COFDM "HDMH 764 T"
- 1 RF connection cable
- 1 Brief Assembly Instructions

2.2 MEANING OF THE SYMBOLS USED



Important note



General note

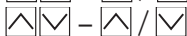
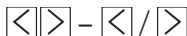

Optional use of the buttons



Performing works

2.3 TECHNICAL DATA

The requirements of the following EU directives are met:
2006/95/EC, 2004/108/EC

The product fulfils the guidelines and standards for CE labelling (page 43).

Unless otherwise noted all values are specified as "typical".

RF input

Frequency range: 910 ... 2150 MHz
Level range: 60 dB μ V ... 80 dB μ V
DVB-S modes: QPSK $1/2, 2/3, 3/4, 5/6, 7/8$
DVB-S2 modes: QPSK $1/2, 3/5, 2/3, 3/4, 4/5, 5/6, 8/9, 9/10$
8PSK $3/5, 2/3, 3/4, 5/6, 8/9, 9/10$
Symbol rate DVB-S: QPSK: 1 ... 45 MSymb/s
Symbol rate DVB-S2: QPSK: 4.5 ... 45 MSymb/s
8PSK: 4.5 ... 45 MSymb/s

COFDM modulator

Signal processing: DIN EN 300744
Transmission modes: 2k
Types of modulation: QPSK, 16 QAM, 64 QAM
Code rates: $1/2, 2/3, 3/4, 5/6, 7/8$
Guard intervals: $1/4, 1/8, 1/16, 1/32$

RF output

Frequency range: 42.0 MHz ... 860.0 MHz
Channels: C5 ... C12, C21 ... C69
Output level: 83 dB μ V
Output impedance: 75 Ω
LNC 12V supply/input max. 300mA

Connections:

SAT inputs: 2 F sockets
RF output: 1 F socket
Connection strip (20-pin): for supply voltages and control circuits
Common Interfaces: 2 (several channels can be descrambled).

2.4 DESCRIPTION

The Head-end Digital Transmodulator COFDM "HDMH 764 T", in the following called COFDM module converts four DVB-S/DVB-S2 modulated data streams into four DVB-T (COFDM) modulated data streams. The COFDM module has two SAT-IF inputs and one RF output.

The COFDM module is equipped with four channel strips ("**A**" ... "**D**"). The channel strips consist of the digital SAT tuners, the digital signal processing levels and an output converter. For channel strips A/B resp. C/D adjacent channel setting is fixed.

Using adequate CA modules scrambled channels can be descrambled via channel strips "**A**" and "**C**". The control of the module takes place via the control unit of the head-end station.

Four LEDs indicate if the respective channel strip is switched on (LED illuminates) or off, and also provide an indication of the signal quality based on their colour.

The integrated TPS module (Transport Stream Processing) processes the data from the demodulated transport streams.

Channel as well as frequency setting is possible for modulators "**A**" and "**C**". The modulators "**B**" and "**D**" work at the adjacent channels of modulators "**A**" and "**C**". Herein only frequency setting (frequency spacing of channel strips "A <-> B" and "C <-> D") is possible to reduce the bandwidth at signals of low data rates.

The COFDM modulated RF output signals are sent through the RF output of the COFDM module to the output collector.

When the head-end station is switched on, the two-line LC display shows the "**SETUP**" menu and the software version of the control unit. The head-end station output level can be adjusted in this menu.

To operate the COFDM module the software version of the control unit (head-end station) must be "**V 10**" or higher. The operating software of the COFDM module and the head-end station can be updated using a PC or notebook and the software "**BE-Flash**" via the 9-pin D-SUB socket on the head-end station. You can find the current operating software for the head-end station and the COFDM module, the software "**BE-Flash**" and the current assembly instructions on the website "www.gss.de/en".

The COFDM module is designed exclusively for use in the STC 160 head-end station.

HOW THE TPS MODULE WORKS

After decoding QPSK- or 8PSK-modulated signals, the demodulated data streams can be accessed via the integrated TPS module. These data streams, also called transport streams, contain several stations with all their components (video, audio, data and service information), which can be changed using the TPS module.

STATION FILTER

Individual stations can be deleted. This reduces the data rate and, consequently, the output data rate.

CHANGING THE TRANSPORT STREAM AND ORGNET-ID

The transport stream ID can be changed. If the stations of a transponder are split into the transport streams of different channel strips, a new identification must be allocated to the "new" transport streams to realise the channel search of the settop boxes connected without mistakes.

If the ORGNET-ID is changed a new NIT must be generated.

CHANGING THE NIT

The transport stream contains data in the form of tables which the receivers evaluate and require for convenient use. The TPS module can adjust the "Network Information Table" (NIT) to accommodate the new stations output data (incl. LCN). The "NIT" contains data which is required by the set-top boxes connected to the cable network for the automatic search feature.

3 INSTALLATION



- Ensure the head-end station is mounted so it will not be able to vibrate. Avoid, for example, mounting the head-end station onto a lift shaft or any other wall or floor construction that vibrates in a similar way.
- Before installing or changing a module, switch off the head-end station or unplug the power cable from the mains power socket.



- Take measures to protect against ESD!
- Open the housing of the head-end station in accordance with the assembly instructions for the STC 160.

3.1 RETROFITTING A CA MODULE

The cassette is equipped with two common interfaces. This allows you to connect two CA modules for various scrambling systems and service providers. Scrambled channels can only be descrambled with a CA module suitable for the scrambling system and the corresponding smart card. The smart card contains all the information for authorisation, descrambling and subscription.



- Check with the distributor or manufacturer of the CA modules to be used to ensure that they are suitable for descrambling several channels.
- **The hardware and software of this cassette have been thoroughly prepared and tested.**
- **Any changes made by programme provider to the structures in the programme data might impair or even prevent this function.**
- When working with the CA modules, please read the corresponding operating manuals from the respective providers.

- Insert the smart card (1) into the CA module (2) so that the chip (3) on the smart card faces the thicker side (top) of the CA module (fig. 1).
- Push the CA module (2) without canting into the guide rails (4) of the common interface (5) according to the following picture and contact it to the common interface.

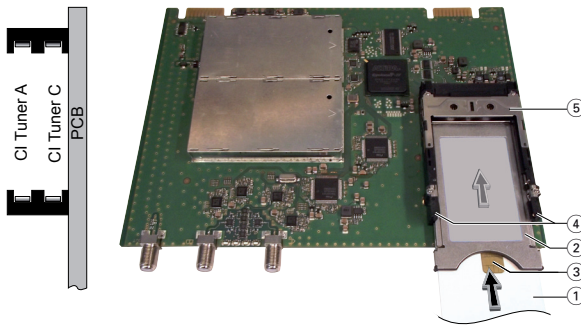

Fig. 1

→ If the COFDM module is inserted in the head-end station, the left common interface is assigned to tuner A, the right one to tuner C.

3.2 INSTALLING THE COFDM MODULE



- Check that the plug contacts of the CA module are tightly seated in the terminal strips on the common interface of the COFDM module and make sure there is reliable contact.
- When installing a module, make sure that it is inserted in one of the long, numbered grooves in front of the contact strip on the board at the rear wall of the housing.
- The shorter, non-numbered grooves without a contact strip on the board at the rear wall of the housing are for add-on modules only.
- Open the housing of the head-end station in accordance with the assembly instructions for the STC 160.
- Open the locking device ① in the direction of the arrow (fig. 2).

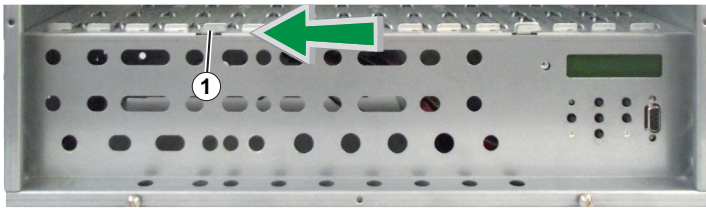

Fig. 2

- Insert the COFDM module in grooves ① and ② of an open slot (with contact strip on the board at the rear wall of the housing) and gently slide it into the head-end station until it makes contact with the board on the rear wall (fig. 3).
- After installing the COFDM module close the locking device ① in the direction of the arrow (fig. 3).

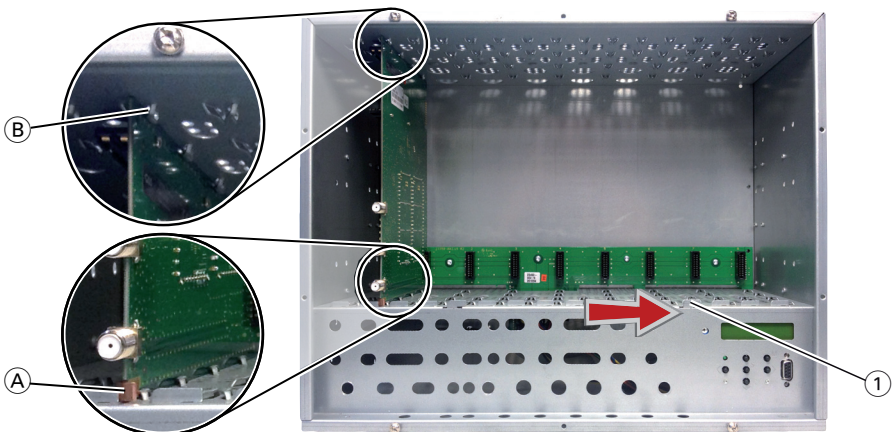

Fig. 3

3.3 CONNECTING THE COFDM MODULE

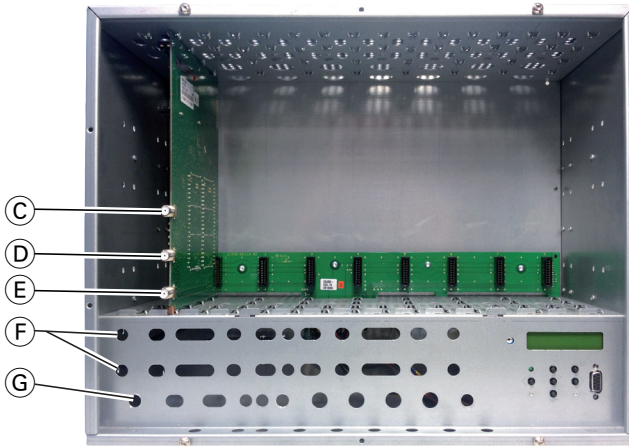
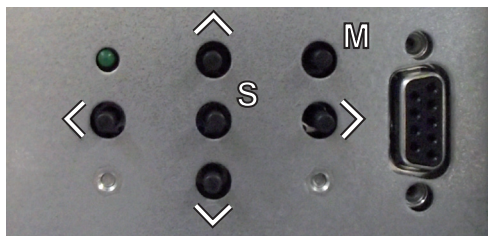







Fig. 4

- Connect SAT-IF inputs ③ (input "In A") and ④ (input "In B") on the COFDM module (fig. 4) to the preinstalled F terminals in the rear wall of the head-end station via the cable inlets ⑥ using RF cables made on-site (length approx. 80 cm) or if applicable connect each to one of the outputs of a retrofitted SAT-IF input distributor.
- After programming, connect the modulator output ⑤ to one of the input sockets ⑦ of a retrofitted output collector.

4 THE CONTROL PANEL AT A GLANCE

4.1 FUNCTIONS OF THE CONTROL PANEL BUTTONS



-   To move the cursor
-   To adjust values and functions
-  To save the programmed data
-  To switch to the next menu

4.2 MENU ITEMS

Programme the COFDM module using the buttons on the head-end station control panel. The menus appear on the two-line display of the control panel. The parameters and functions to be set are underlined>.

With the  button select the channel strip / other modules.

You can use the  button to select the following menu items:

- Output signal settings:
 - Modulator on/off, level
 - Output channel (modulators A and C)
 - Output frequency (modulators A...D)
 - Transmission parameters
 - Substitute signal
- Input signal settings:
 - LNB oscillator frequency
 - Input symbol rate
 - Input frequency
 - Station filter
 - CA module
 - Economize descrambling capacity
- Options:
 - Transport stream and ORGNET-ID
 - BAT, STD-other
 - Deleting a PID
 - Renaming a PID
- Data rate
- Network Information Table (NIT)
- Factory reset
- Save data

5 PROGRAMMING

5.1 PREPARATION

- Test the software versions of the head-end station and the COFDM module and update them if necessary. The current software versions can be found on the website "www.gss.de/en".
- Connect the test receiver to the modulator output on the COFDM module (D) or to the RF output on the output collector if it is already connected (page 10).
- Adjust the test receiver to the output channel / output frequency of the channel strip to be set.
- Switch on the channel strip (modulator) if necessary (page 18). For each channel strip, there is an status LED which indicates if the channel strip is switched on.

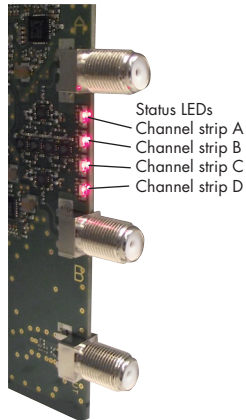

- Balance the output levels of the channel strips "A" and "B" and level them to the output levels of the modulators of other modules used if the difference in level is ≥ 1 dB (page 18).

—> In order to prevent interference within the head-end station and the cable system, the output level of the COFDM module must be lowered by 8 dB compared to modules with analogue modulators.

5.2 PROGRAMMING PROCEDURE

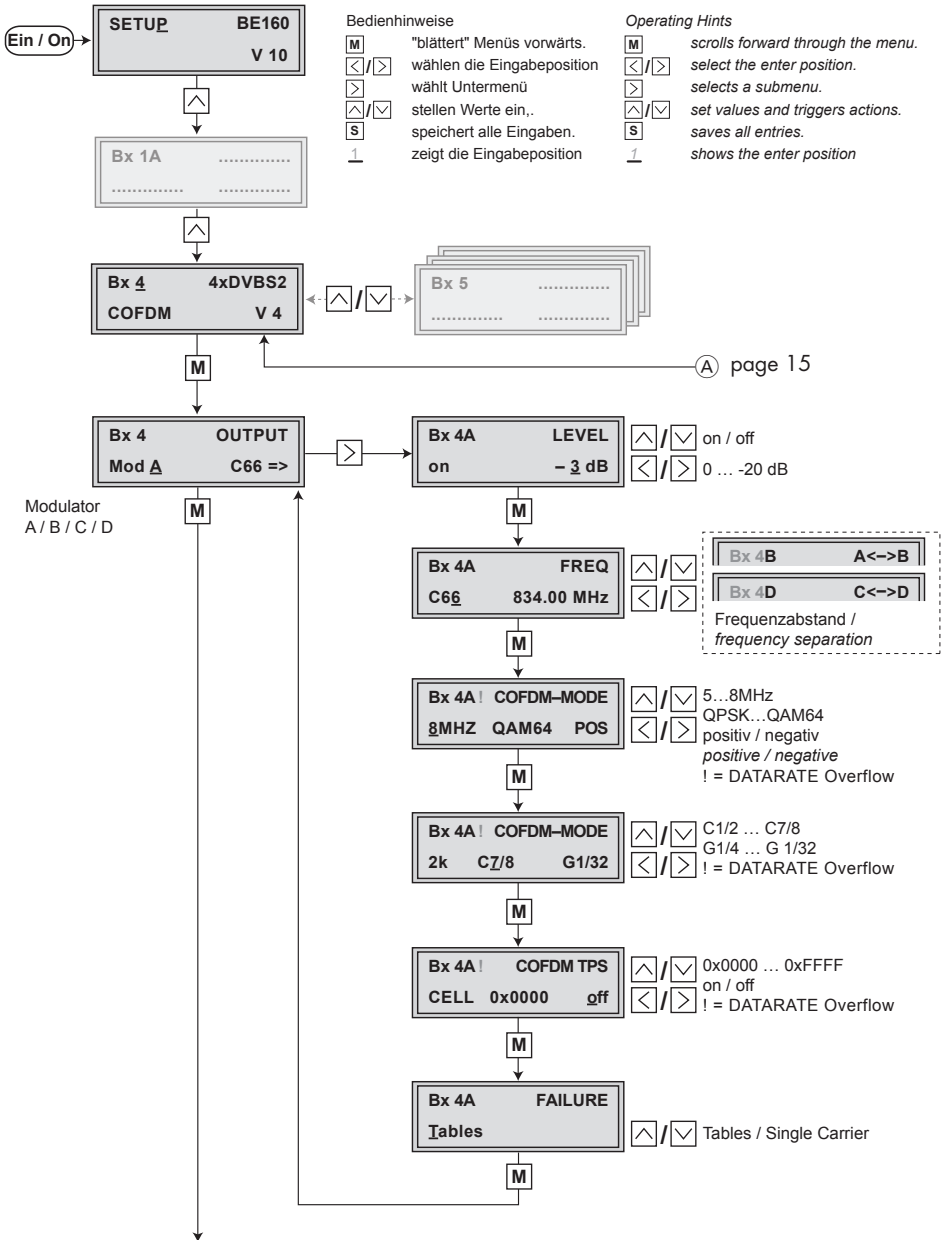

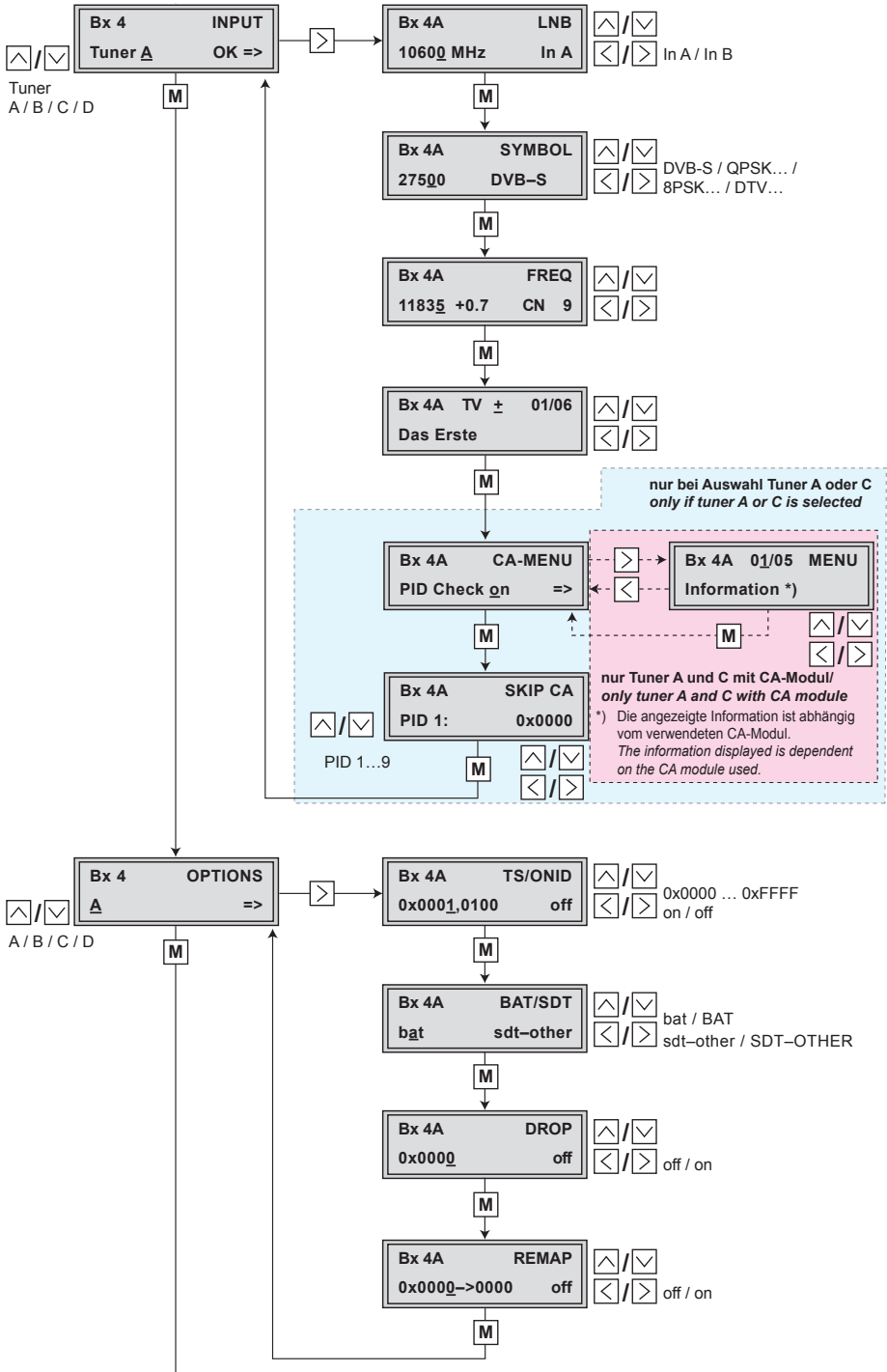

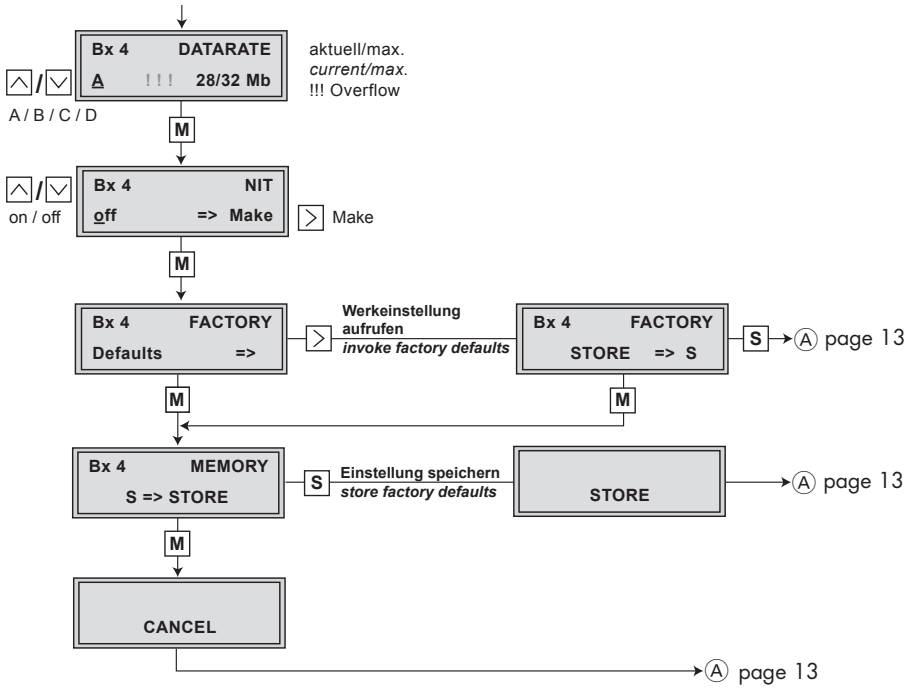

Notes:

- Entries are saved by pressing the **[S]** button.

→ You will be returned to "Selecting the module/channel strip".

- The programming process can be cancelled by pressing and holding the **[M]** button (changes will NOT be saved).

→ You will be returned to "Selecting the module/channel strip".

- Switch on the head-end station.

→ The display shows "SETUP BE160" and the software version of the head-end station (e.g. V 10).

→ The output level of the output collector can be adjusted in the "SETUP" menu (see STC 160 assembly instructions).

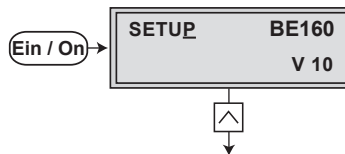

SELECTING THE MODULE / CHANNEL STRIP

- If necessary, press **[^]**/**[v]** repeatedly to select the particular module (**Bx ...**) to be programmed.



→ The display shows, e.g., the " **Bx 4** **4xDVBS2**
COFDM **V 4** " menu.

"**Bx 4**" indicates the slot no. 1

"**4xDVBS2 COFDM V4**" type of the module

"**COFDM V4**" software version of the module

- Press the **M** button.

—> The "Output settings" – "**OUTPUT**" main menu is activated.

OUTPUT SETTINGS

In this menu you select the modulator for which you would like to do the output settings in the related submenus.

Bx 4	OUTPUT
Mod <u>A</u>	C66 =>

—> In order to skip the "Output settings", press button **M**.
 —> For example an indicated "C66" shows the current channel set. If "C – –" is displayed a frequency which does not correspond to the DVB-T channel-/frequency grid was set.

- Using buttons **▲** **▼** select the desired modulator.
- Press the **▶** button.

—> The "Modulator on/off, Level" – "**LEVEL**" submenu is activated.

MODULATOR ON/OFF, LEVEL

This menu item is used to set the output levels of the modulators of the modul's channel strips to the same value and to level them to the output levels of the modulators of other modules used and to switch the modulators on or off.

Bx 4A	LEVEL
on	- 3 dB

Level setting:

- Measure and note down the output level of all modulators (of the whole head-end station).
- By pressing adjust the higher output levels to the output level of the modulator with the lowest output level incrementally.

Switching the modulator on or off:

- Use the button to place the cursor under "on" resp. "off".
- Use the buttons to switch each modulator on or off.
- Press the button.

→ The "Channel / Frequency" – "FREQ" submenu is activated.

CHANNEL / FREQUENCY

In this menu you can adjust the output channel (only at modulator A and C) or the output frequency of the respective modulator.

- The channel setting is only possible at modulators "A" and "C". The modulators "B" and "D" are fixed to the upper adjacent channel of "A" and "C". Only the distance to the adjacent channels can be set via the frequency setting.
- The COFDM signal is normally transmitted with a bandwidth of 8 MHz. This means that you can only use the channel centre frequency of the existing channel grid in the range of channels C21...C69 (frequency grid 8 MHz).

The CCIR channel grid is 7 MHz in the range of the lower frequency bands (channels C5 ... C12, S2...S20). If 8 MHz COFDM signal packages are transmitted in these channel ranges, this will result in interference (overlapping) and transmission problems.

For programming in these channel ranges and in the frequency ranges below them, we recommend starting with frequency 306 MHz going back in steps of 8 MHz (see frequency table on page 42). Please note thereby that many receivers cannot receive the channel ranges S21 ... S41 (306 ... 466 MHz).

Channel setting (only modulators "A" and "C"):

Bx 4A	FREQ
C66	834.00 MHz

Bx 4C	FREQ
C68	850.00 MHz

- Use buttons to select the cursor position for channel setting.
- Use buttons to adjust the desired channel.

Frequency setting (modulators "A" ... "D"):

Bx 4A	FREQ
C66	834.00 MHz

Bx 4B	A <-> B
C67	842.00 MHz

Bx 4C	FREQ
C68	850.00 MHz

Bx 4D	C <-> D
C69	858.00 MHz

- Use buttons to select the cursor position for frequency setting.
- Use buttons to adjust the desired frequency.
- Press the button.

—> The "Output signal" – "COFDM-MODE" submenu is activated. Please take note of the tables below before setting the COFDM parameters.

COFDM PARAMETERS

The tables below show the dependence of the transmittable net data rate on the settings of the COFDM parameters.

The conversion of the net data rate into the gross data rate displayed in the "Output data rate" menu (page 37) is made according to the following formula:

$$\text{Gross data rate} = \frac{204 \times \text{net data rate}}{188}$$

		Net data rate [kbit/s] at a bandwidth of 8 MHz			
		Guard interval			
Modulation	Code rate	1/4	1/8	1/16	1/32
QPSK	1/2	4976	5529	5855	6032
	2/3	6635	7373	7806	8043
	3/4	7465	8294	8782	9048
	5/6	8294	9216	9758	10053
	7/8	8709	9676	10246	10556
16 QAM	1/2	9953	11059	11709	12064
	2/3	13271	14745	15612	16086
	3/4	14929	16588	17564	18096
	5/6	16588	18431	19516	20107
	7/8	17418	19353	20491	21112
64 QAM	1/2	14929	16588	17564	18096
	2/3	19906	22118	23419	24128
	3/4	22394	24882	26346	27144
	5/6	24882	27647	29273	30160
	7/8	26126	29029	30737	31668

If the bandwidth is decreased by 1 MHz the transmittable data rate is decreased by approx. $\frac{1}{8}$.

		Net data rate [kbit/s] at a bandwidth of 7 MHz			
		Guard interval			
Modulation	Code rate	$\frac{1}{4}$	$\frac{1}{8}$	$\frac{1}{16}$	$\frac{1}{32}$
QPSK	$\frac{1}{2}$	4354	4838	5123	5278
	$\frac{2}{3}$	5806	6451	6830	7037
	$\frac{3}{4}$	6532	7257	7684	7917
	$\frac{5}{6}$	7257	8064	8538	8797
	$\frac{7}{8}$	7620	8467	8965	9237
16 QAM	$\frac{1}{2}$	8709	9676	10246	10556
	$\frac{2}{3}$	11612	12902	13661	14075
	$\frac{3}{4}$	13063	14515	15369	15834
	$\frac{5}{6}$	14515	16127	17076	17594
	$\frac{7}{8}$	15240	16934	17930	18473
64 QAM	$\frac{1}{2}$	13063	14515	15369	15834
	$\frac{2}{3}$	17418	19353	20491	21112
	$\frac{3}{4}$	19595	21772	23053	23751
	$\frac{5}{6}$	21772	24191	25614	26390
	$\frac{7}{8}$	22861	25401	26895	27710

		Net data rate [kbit/s] at a bandwidth of 6 MHz			
		Guard interval			
Modulation	Code rate	$\frac{1}{4}$	$\frac{1}{8}$	$\frac{1}{16}$	$\frac{1}{32}$
QPSK	$\frac{1}{2}$	3732	4147	4391	4524
	$\frac{2}{3}$	4976	5529	5855	6032
	$\frac{3}{4}$	5599	6221	6587	6786
	$\frac{5}{6}$	6221	6912	7318	7540
	$\frac{7}{8}$	6532	7257	7684	7917
16 QAM	$\frac{1}{2}$	7465	8294	8782	9048
	$\frac{2}{3}$	9953	11059	11709	12064
	$\frac{3}{4}$	11197	12441	13173	13572
	$\frac{5}{6}$	12441	13824	14637	15080
	$\frac{7}{8}$	13063	14515	15369	15834
64 QAM	$\frac{1}{2}$	11197	12441	13173	13572
	$\frac{2}{3}$	14929	16588	17564	18096
	$\frac{3}{4}$	16796	18662	19760	20358
	$\frac{5}{6}$	18662	20735	21995	22620
	$\frac{7}{8}$	19595	21772	23053	23751

	Transmission parameters for DVB-T at a bandwidth of 8 MHz											
Transmission mode	2k				4k				8k			
Symbol duration T_S [μ s]	224				448				896			
Carrier space Δf [kHz]	4.4643				2.232				1.116			
$(n_{\text{carrier}})_{\text{theoretical}}$	2048				4096				8192			
$(n_{\text{carrier}})_{\text{real}}$	1705				3410				6817			
Used bandwidth [MHz]	7.61				7.61				7.61			
Total symbol duration T_{GS} [μ s]	280	262	238	231	560	504	476	462	1120	1008	952	924
Guard interval T_G [μ s]	56	28	14	7	112	56	28	14	224	112	56	28
T_G / T_S	$1/4$	$1/8$	$1/16$	$1/32$	$1/4$	$1/8$	$1/16$	$1/32$	$1/4$	$1/8$	$1/16$	$1/32$

	Transmission parameters for DVB-T at a bandwidth of 7 MHz											
Transmission mode	2k				4k				8k			
Symbol duration T_S [μ s]	224				448				896			
Carrier space Δf [kHz]	4.4643				2.232				1.116			
$(n_{\text{carrier}})_{\text{theoretical}}$	2048				4096				8192			
$(n_{\text{carrier}})_{\text{real}}$	1705				3410				6817			
Used bandwidth [MHz]	6.66				6.66				6.66			
Total symbol duration T_{GS} [μ s]	320	288	272	264	620	576	544	528	1280	1152	1088	1056
Guard interval T_G [μ s]	64	32	16	8	128	64	32	16	256	128	64	32
T_G / T_S	$1/4$	$1/8$	$1/16$	$1/32$	$1/4$	$1/8$	$1/16$	$1/32$	$1/4$	$1/8$	$1/16$	$1/32$

	Transmission parameters for DVB-T at a bandwidth of 6 MHz											
Transmission mode	2k				4k				8k			
Symbol duration T_S [μ s]	224				448				896			
Carrier space Δf [kHz]	4.4643				2.232				1.116			
$(n_{\text{carrier}})_{\text{theoretical}}$	2048				4096				8192			
$(n_{\text{carrier}})_{\text{real}}$	1705				3410				6817			
Used bandwidth [MHz]	5.71				5.71				5.71			
Total symbol duration T_{GS} [μ s]	373	336	317	308	767	672	634	616	1493	1344	1269	1232
Guard interval T_G [μ s]	74.7	37.3	18.7	9.3	149	75	37.4	18.6	298.7	149.3	74.6	37.3
T_G / T_S	$1/4$	$1/8$	$1/16$	$1/32$	$1/4$	$1/8$	$1/16$	$1/32$	$1/4$	$1/8$	$1/16$	$1/32$

OUTPUT SIGNAL

In this menu, you can set the bandwidth, the carrier modulation and the spectral position of the output signal.

Bx 4A ! COFDM-MODE
8MHz QAM64 POS

Bandwidth of the output signal

To transmit the output signal in the channel range of C21 to C69 a bandwidth of 8 MHz can be used.

In the channel range of C5 to C12 a bandwidth of ≤ 7 MHz must be set.

If frequency setting is selected you can set the bandwidth dependent on the frequency of the adjacent channel.

Bx 4A ! COFDM-MODE
8MHz QAM64 POS

- Use to set the bandwidth of the output signal ("5 MHz" ... "8 MHz").

Carrier modulation

In this menu item the carrier modulation is set. At this the setting "QPSK" corresponds to the lowest and the setting "QAM64" to the highest output data rate.

- Use the buttons to place the cursor under "QPSK / QAM...".
- Set the carrier modulation of the output signal using the buttons ("QPSK", "QAM16", "QAM64").

—> A displayed "!" indicates an output data rate overflow (page 37).

Bx 4A ! COFDM-MODE

Spectral position – inverting the user signal

For exceptional cases and "older" digital cable receivers, the spectral position of the user signal can be inverted "NEG". The default setting is "POS".

- Use to place the cursor under "POS".
- Use to set the spectral position to "NEG".
- Press the button.

→ The "Transmission parameters" – "COFDM-MODE" submenu is activated.

TRANSMISSION PARAMETERS

In this menu you can set the code rate and the guard interval.

Bx 4A ! COFDM-MODE		
2k	C7/8	G1/32





→ The 2k transmission mode is fixed.
2k mode: 1512 carrier for user data (total 1705 carriers)
→ A displayed "!" indicates an output data rate overflow (page 37).

Bx 4A ! COFDM-MODE		
--------------------	--	--

Code rate





During a transmission data can be lost or changed. To recover this data redundancy is added to the signal to be transmitted (forward error correction). The factor of the quantity of redundancy contained in the bits transmitted is called code rate.

Using the setting "C7/8" you can get the highest output data rate at lowest redundancy.

- Use the   buttons to place the cursor under "C...".
- Set the code rate required using the   buttons ("C1/2", "C2/3", "C3/4", "C5/6", "C7/8").

Guard interval

In this menu item you set the relation of the duration of the user symbols to the duration of the guard intervals to be transmitted. A high guard interval, e.g. "G1/4" causes a low output data rate. For cable networks the setting "G1/32" is adequate.

- Use the   buttons to place the cursor under "G...".
- Set the guard interval required using the   buttons ("G1/4", "G1/8", "G1/16", "G1/32").
- Press the  button.

—> The "Transmitter identification" – "COFDM TPS" submenu is activated.

TRANSMITTER IDENTIFICATION

At terrestrial transmission an identification is referred to each COFDM modulated transmitter. When COFDM modulated signals are fed into cable networks this identification is not necessary usually. If receiving problems should occur you must refer a transmitter identification (CELL ID) to each output channel and switch "on" the transmitter identification.

Bx 4A !	COFDM TPS
CELL 0x0000	off

—> A displayed "!" indicates an output data rate overflow (page 37).

- Use the buttons to position the cursor under the digit of the hexadecimal number to be set.
- Press to set the respective digit of the hexadecimal number.
- Repeat the procedure by the quantity of the digits to be set.
- Using the button place the cursor under "off" and switch "on" the transmitter identification using the buttons.

—> By pressing the button you return to the hexadecimal number setting.



- Press the button.

—> The "Substitute signal in the case of an incorrect input signal" – "FAILURE" submenu is activated.

SUBSTITUTE SIGNAL IN THE CASE OF AN INCORRECT INPUT SIGNAL

You use this menu to set whether a COFDM signal filled with null packets and self-made tables "Tables" or a "Single Carrier" signal should be provided as an output signal whenever an incorrect input signal occurs. Self-made tables are transmitted furthermore.



- Use the   buttons to set the required output signal.
- Press the  button.

—> Returning to "Output settings" main menu (page 17).
—> If necessary set further modulators.

- Press the  button.

—> The "Input settings" – "INPUT" main menu is activated.

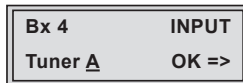

INPUT SETTINGS

In this menu you select the tuner for which you would like to do the input settings in the related submenus.



—> In order to skip the "Input settings", press button .

—> "OK" indicates a present input signal.

- Using the buttons   select the desired tuner ("A"..."D").
- Press button .

—> The "LNB oscillator frequency, Input" – "LNB" submenu is activated.

LNB OSCILLATOR FREQUENCY, INPUT

In this menu select the SAT input and set the oscillator frequency of the LNB used.

Bx 4A	LNB
10600 MHz	In A

- Use buttons \leftarrow \rightarrow to place the cursor under the digit to be set for the oscillator frequency displayed.
- Press buttons \uparrow \downarrow to enter the respective digit of the oscillator frequency of the LNB used.
- Repeat the procedure by the quantity of the digits to be set.
- Use button \rightarrow to place the cursor under "In A" resp. "In B".
- Press buttons \uparrow \downarrow to select the respective SAT input ("A" or "B").

- Press the **M** button.

→ The "Input symbol rate, DVB mode" – "**SYMBOL**" submenu is activated.

INPUT SYMBOL RATE, DVB MODE

In this menu set the symbol rate and the DVB mode of the desired transponder.

Bx 4A	SYMBOL
27500	DVB-S





Symbol rate:

The symbol rates of the satellite transponders can be found in the current channel table of the satellite operator, in various satellite magazines and in the Internet.

- Use \leftarrow \rightarrow to position the cursor under the digit to be set for the symbol rate displayed.
- Press \uparrow \downarrow to enter the respective digit of the symbol rate needed.
- Repeat the procedure by the quantity of the digits to be set.

DVB mode:

The cassette recognizes the transmitted DVB mode and switches over between the normal QPSK mode (DVB-S) and the DVB-S2 mode. Receiving stations with DVB-S2 mode, we suggest to preset the DVB mode to shorten the time for searching stations.

- Use the  button to place the cursor under "**DVB-S**" and set the required DVB-S2 mode with the buttons  .
- Press the  button.

—> The "Input frequency" – "**FREQ**" submenu is activated.







INPUT FREQUENCY

If three dots " ... " appear in the second line of the display, the cassette is in the "**station search**" mode. Please wait until the process has finished.

Once the RF receiver has synchronised to the input signal, any offset to the target frequency is displayed in MHz, e.g. "**- 1.8**".

If a question mark "?" appears in the second line of the display, there is no input signal present. In this case check the configuration of the antenna system and head-end station as well as the preceding settings of the cassette.

Bx 4A	FREQ
11835 +0.7	CN 9

- Use   to position the cursor under the digit of the frequency displayed to be set.
- Press   to set the respective digit of the input frequency needed.
- Repeat the procedure by the quantity of the digits to be set.
- Set the frequency offset shown in the display (e.g. "**- 1.8**") to less than 1 MHz by varying the input frequency using the   buttons.

Signal to noise ratio:

"CN ..." indicates the current signal to noise ratio, in order to estimate the quality of the input signal.

—> In addition to the indicator in the display, there is also a status LED which indicates the quality of the received transport stream:

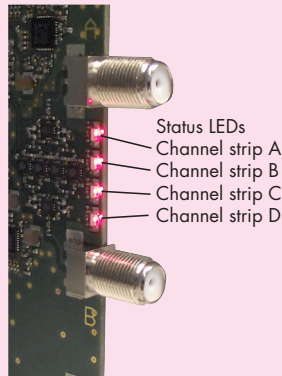

LED indicator	Indication
Green	Signal quality is good
Yellow	Signal quality is insufficient
Red	No signal
Blinking red/green	Data overflow of the output data rate
Off	The channel strip (modulator) is switched off

- Press the **M** button.

—> The "Station filter" – e.g. "01/06" submenu is activated.

OPERATION WITH A CA MODULE

In order to descramble scrambled channels a corresponding smart card is needed.

The channels to be descrambled are set in submenu "station filter".

STATION FILTER

In this menu stations (services) of a transponder can be switched off.

Herein you select which scrambled station should be descrambled using an adequate CA module (only via tuner "A" and "C").

Bx 4A TV ± 01/06
Das Erste

- All stations from the channel strip will be read, and then displayed with name and station type.
- If no station is found, the following message will appear in the display: **"FILTER no Service"**.
In this case, check the configuration of the antenna system and head-end station, as well as the previously adjusted settings for the cassette.
- The display shows e.g.: **Bx 4A TV + 01/06**

Das Erste





Meaning of the indicators in the example:

"Bx 4A"	Slot 4, channel strip "A"
"TV"	TV channel type
" + "	The currently selected station is switched on.
"01/06"	The 1st of 6 stations is being displayed.
"Das Erste"	Station name

Further possible terms displayed:

"RA"	Radio channel type For radio stations, the background of the screen of the connected TV or test receiver is darkened.
" - "	The currently selected station is switched off.
" * "	The star means that the TV or radio station selected is scrambled. To enable the station, the CA module and the appropriate smart card of the station provider are required.

- If a service number (e.g. "131") appears instead of "TV" or "RA", this indicates that an unnamed station or an undefined data stream is being received.

- Use the   buttons to call up the stations in sequential order, then use   to activate (indicated by " + ") or to deactivate them (indicated by " - ").

- If a station is scrambled (indication "*"), in this menu you select whether it should be descrambled using an adequate CA module (only possible via tuner "A" and "C").

- Press button  twice to descramble a station (indication "X").

Bx 4A	TV *X	01/06
-------	-------	-------

- Press the  button.

—> The "PID monitoring" – "**CA-MENU**" submenu is activated.

PID MONITORING



—> This menu is only displayed if "Tuner A/C" is selected in the "Input settings" main menu (page 26).

In this menu you can switch off the PID monitoring and call up a menu for the settings of the CA module (dependent on the CA module).

Bx 4A	CA-MENU
PID Check on	=>

PID monitoring:

—> The factory default of the PID monitoring is switched on. If particular PIDs are not descrambled the CA module is reset. Additionally dropouts may occur if several stations are descrambled. To prevent this the PID monitoring can be switched off.

- Use the   buttons to switch "**off**" or "**on**" the PID monitoring.
- Use the  button to activate the menu of the CA module (only if Tuner "A" or "B" is selected).

—> Access to this menu is only possible with installed **CA module** and inserted smart card.

The menu varies according to which CA module you are using. For this reason, please refer to the operating manual of your particular CA module. The relevant information is shown in the display of the head-end station. This may appear as a fixed display or as scrolling text according to display capabilities.

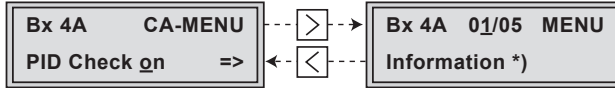

—> The display shows e.g.: **Bx 4A 01/05 MENU**

Meaning of the indicators:

- "Bx 4A" Slot 4, tuner "A"
- "01/05" The first of five menu items is activated.
- "MENU" The menu of the CA module is activated.

*) For the explanation of further details please use the operating instructions of the CA module used.

- Use the buttons to activate the menu desired.
- Press the button to activate the menu.
- Use the buttons to select the function desired.
- To set the CA module use the and buttons.

—> By pressing the button you can cancel the settings in the menu of the CA module and are returned to the "PID monitoring" – "**CA-MENU**" menu.

- All settings are saved by pressing the button.

—> You will be returned to the "PID monitoring" – "**CA-MENU**" menu.







- Press the button.

—> The "Economize descrambling capacity" – "**SKIP CA**" is activated.

—> This menu is only available if "Tuner A/C" is selected in menu "Input settings" (page 26).

In this menu up to 9 not needed PIDs (e.g. audio PIDs of foreign language versions) can be excluded from the descrambling in order to economize descrambling capacity.

Bx 4A	SKIP CA
PID 1:	0x0000

- Using buttons   select the desired memory location (PID 1...9) .
- Use   to position the cursor under the digit of PID to be set.
- Press   to set the respective digit of the PID needed (as hexadecimal value).
- Repeat the procedure by the quantity of the digits to be set.

—> If required select another memory location and enter the next PID which shall **not** descrambled.

—> To delete a stored PID, overwrite it by "0000".

- Press the  button.

—> Returning to "Input settings" main menu (page 26).

—> If necessary set further tuners.

- Press the  button.

—> The "Option settings" – "**OPTIONS**" main menu is activated.

OPTION SETTINGS

In this menu you select the channel strip for which you would like to do the option settings in the related submenus.



—> In order to skip the "Option settings", press button **M**.

- Using the buttons **▲****▼** select the desired channel strip ("A"..."D").
- Press button **▶**.

—> The "Transport stream ID and ORGNET-ID" – "**TS/ONID**" submenu is activated.

TRANSPORT STREAM ID AND ORGNET-ID

If the stations of a transponder are split into the transport streams of several channel strips, a new identification must be allocated to the further transport streams to realise the channel search of the settop boxes connected without mistakes.

—> If the ORGNET-ID is changed also a new NIT must be generated (page 37).

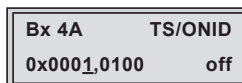

- Use the **◀****▶** buttons to position the cursor under the digit of the hexadecimal number to be set.
- Press **▲****▼** to set the respective digit of the hexadecimal number.
- Repeat the procedure by the quantity of the digits to be set.
- Using the **▶** button place the cursor under "**off**" and switch "**on**" the transmitter identification using the **▲****▼** buttons.

—> By pressing the **◀** button you return to the hexadecimal number setting.

- Press the **M** button.

→ The "BAT/SDT-OTHER tables" – "**BAT/SDT**" submenu is activated.

BAT/SDT-OTHER TABLES

In this menu you can switch on resp. off the BAT- and SDT-OTHER tables.







→ **BAT = Bouquet Association Table:**

Information in the data stream about the affiliation of station packets to a specific bouquet.

→ **SDT-OTHER = Service Description Table – OTHER data streams:**

Information in the data stream about service parameter of other data streams.

Bx 4A	BAT/SDT
bat	sdt-other

- Using the  button place the cursor under "**bat**" and switch "on" ("**BAT**") or "off" ("**bat**") the bouquet association table using the   buttons.
- Using the  button place the cursor under "**sdt-other**" and switch "on" ("**SDT-OTHER**") or "off" ("**sdt-other**") the service description table using the   buttons.

→ Capital letters: Function activated

Lower case letters: Function deactivated (factory default)





- Press the  button.





→ The "Deleting a PID" – "**DROP**" submenu is activated.

DELETING A PID

In this menu a PID of the transport stream can be deleted.

Bx 4A	DROP
0x0000	off

- Use the   buttons to place the cursor under the respective digit of the hexadecimal number of the PID to be deleted ("**0x0000**") and set the hexadecimal number using  .









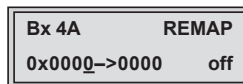



- Use the  button to set the cursor under "off" and delete the PID using the   buttons ("on").
- Press the  button.

—> The "Renaming a PID" – "**REMAP**" submenu is activated (page 36).

RENAMING A PID

In this menu you can allocate a new address to a PID retaining the complete data content.



- Use the   buttons to place the cursor under the respective digit of the hexadecimal number of the PID to be changed ("0x0000") and set the hexadecimal number using  .
- Use the   buttons to place the cursor under the respective digit of the hexadecimal number of the new PID ("→ 0000").
- Set the hexadecimal number using  .
- Use the  button to set the cursor to "off" and rename the PID using the   buttons ("on").
- Press the  button.

—> Returning to "Option settings" main menu (page 34).
 —> If necessary set further channel strips.

- Press the  button.

—> The "Output data rate" – "**DATARATE**" main menu is activated.

OUTPUT DATA RATE

This menu shows the output data rate defined using the COFDM settings and the current output data rate.



28: The current measured gross output data rate.

32: Maximum gross output data rate (dependent on the settings of modulation and symbol rate).

If the station filter is set correctly, current data rate is lower than the maximum data rate. The value fluctuates, since the data rates of individual stations are dynamically modified by the broadcasters.

—> Is the current data rate higher than the maximum data rate exclamation marks "!!!" appear in the display and the status LED is blinking red/green. In this case correct the COFDM settings (pages 23 ...) or the settings of the station filter (page 29).

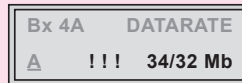

- Press the **M** button.

—> The "Network Information Table" – "NIT" main menu is activated.

NETWORK INFORMATION TABLE (NIT)

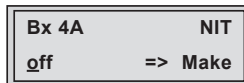

- To switch NIT "on" resp. "off" press the buttons.
- Press the button to activate NIT ("**Make**").



All active cassettes which are able to output a NIT ("NIT cassettes") must be set and ready for reception.

—> The NIT of all "NIT cassettes" are switched on.
—> The cassette fetches all the information (output frequencies, output data rates, etc.) it needs from all the "NIT cassettes" in order to generate the NIT. This process may take a few seconds.
Then the NIT is generated, added and sent to all "NIT cassettes".
The other "NIT cassettes" also add this new NIT. The status of all "NIT cassettes" in the NIT menu changes to "on".
The display shows: "read ... / copy ...".

- To switch off the new NIT ("off") press the button.

—> The NITs of the other "NIT cassettes" will stay switched on. When the NIT of the cassette is switched on again ("on") by pressing the button, the previously generated NIT is added again. If you have changed parameters in the meantime, you must first select "Make" to generate a new, up-to-date NIT.

- Press the button.

—> The "Factory reset" – "FACTORY Defaults" main menu is activated.

FACTORY RESET

In this menu you can reset all settings to the factory defaults.

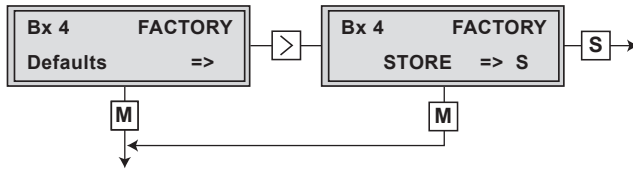

- Press the button.

—> The factory defaults are invoked ("FACTORY STORE").
—> By pressing the button, you will be returned to the menu item "Output settings" **without** invoking the factory defaults (page 17).

- Press the button.

—> The factory defaults are saved.
The display shows "STORE"
—> Back to "Selecting the module" (page 16).
—> By pressing the button, you will be returned to the menu item "Output settings" **without** saving the factory defaults (page 17).
—> If necessary set another channel strip.

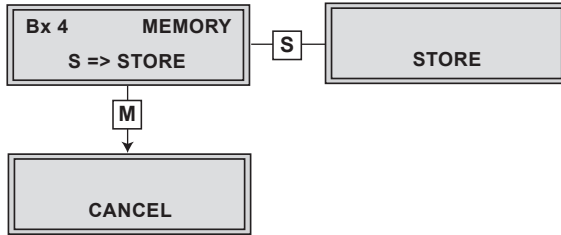

- All programmed data is saved by pressing the **S** button. You will be returned to the menu item "**Selecting the module / channel strip**" via **A** (page 16).

—> By pressing the **M** button, you will be returned to the menu item "**Selecting the module / channel strip**" via **A** **without** saving the programmed data.



After installing the head-end station, upgrading accessories or installing modules it is necessary to tighten all cable connections, cable terminals and cover screws in order to maintain compliance with current EMC regulations.

- Securely tighten the cable connections using an appropriate open-ended spanner.
- After programming, connect the modulator output (E) to one of the input sockets (G) of the output collector (page 10, fig. 4).
- Test the output level of the output collector according to the STC 160 assembly instructions and set the output level required for the cable system.
- Mount the base plate and the front cover (see STC 160 assembly instructions).

7 CHANNEL AND FREQUENCY TABLES

Advice for a frequency grid (8 MHz) in the band I/III

Frequenz Frequency [MHz]	Frequenz Frequency [MHz]	Frequenz Frequency [MHz]	Frequenz Frequency [MHz]	Frequenz Frequency [MHz]	Frequenz Frequency [MHz]
42.00	82.00	146.00	186.00	226.00	266.00
50.00	114.00	154.00	194.00	234.00	274.00
58.00	122.00	162.00	202.00	242.00	282.00
66.00	130.00	170.00	210.00	250.00	290.00
74.00	138.00	178.00	218.00	258.00	298.00

Channel-/frequency grid for DVB-T (band III, bandwidth 7 MHz)

Kanal Channel	Frequenz Frequency [MHz]	Kanal Channel	Frequenz Frequency [MHz]	Kanal Channel	Frequenz Frequency [MHz]
C 5	177.5	C 8	198.5	C 11	219.5
C 6	184.5	C 9	205.5	C 12	226.5
C 7	191.5	C 10	212.5		



CCIR – Hyperband (frequency grid 8 MHz)

Kanal Channel	Kanalmittefrequenz Channel centre frequency [MHz]	Kanal Channel	Kanalmittefrequenz Channel centre frequency [MHz]	Kanal Channel	Kanalmittefrequenz Channel centre frequency [MHz]	Kanal Channel	Kanalmittefrequenz Channel centre frequency [MHz]	Kanal Channel	Kanalmittefrequenz Channel centre frequency [MHz]
S 21	306.00	S 26	346.00	S 30	378.00	S 34	410.00	S 38	442.00
S 22	314.00	S 27	354.00	S 31	386.00	S 35	418.00	S 39	450.00
S 23	322.00	S 28	362.00	S 32	394.00	S 36	426.00	S 40	458.00
S 24	330.00	S 29	370.00	S 33	402.00	S 37	434.00	S 41	466.00
S 25	338.00								

CCIR – Band IV/V (frequency grid 8 MHz)

C 21	474.00	C 31	554.00	C 41	634.00	C 51	714.00	C 61	794.00
C 22	482.00	C 32	562.00	C 42	642.00	C 52	722.00	C 62	802.00
C 23	490.00	C 33	570.00	C 43	650.00	C 53	730.00	C 63	810.00
C 24	498.00	C 34	578.00	C 44	658.00	C 54	738.00	C 64	818.00
C 25	506.00	C 35	586.00	C 45	666.00	C 55	746.00	C 65	826.00
C 26	514.00	C 36	594.00	C 46	674.00	C 56	754.00	C 66	834.00
C 27	522.00	C 37	602.00	C 47	682.00	C 57	762.00	C 67	842.00
C 28	530.00	C 38	610.00	C 48	690.00	C 58	770.00	C 68	850.00
C 29	538.00	C 39	618.00	C 49	698.00	C 59	778.00	C 69	858.00
C 30	546.00	C 40	626.00	C 50	706.00	C 60	786.00		

CE - Declaration of Conformity

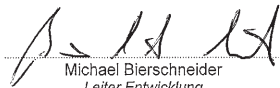
	Konformitätserklärung Declaration of Conformity 112/ 13	
Der Hersteller/Importeur The manufacturer/importer	GSS Grundig SAT Systems GmbH	
Anschrift / Address / Adresse	Beuthener Straße 43, D-90471 Nürnberg, Germany	
erklärt hiermit eigenverantwortlich, daß das Produkt: declare under their sole responsibility that the product:		
Bezeichnung / Name / Description	Head- End Digital Modulator 4x COFDM	
Type / Model / Type	GSS HDMH 764 T	
Bestell-Nr. / Order-No.	GAK 8800	
folgenden Normen entspricht: is in accordance with the following specifications:		
<i>EN 50083-2:</i>	<i>2012</i>	<i>EN 60950:</i> <i>2006</i>
<i>EN 50581:</i>	<i>2012</i>	<i>EN 60950-1 +A11 : 2009</i>
		<i>EN 60950-1 +A1 : 2010</i>
Das Produkt erfüllt somit die Forderungen folgender EG-Richtlinien: Therefore the product fulfils the demands of the following EC-Directives:		
2006/95/EG	Richtlinie betreffend elektrische Betriebsmittel zur Verwendung innerhalb bestimmter Spannungsgrenzen Directive relating to electrical equipment designed for use within certain voltage limits	
2004/108/EG	Richtlinie über die elektromagnetische Verträglichkeit Directive relating to electromagnetic compatibility	
2011/65/EG	Richtlinie zur Beschränkung der Verwendung bestimmter gefährlicher Stoffe in Elektro- und Elektronik Altgeräten Directive on the restriction of the use of certain hazardous substances in electrical and electronic equipment	
Nürnberg, 12. Juni 2013		
 Michael Bierschneider Leiter Entwicklung Manager Development / Directeur Développement		

Service:

Phone: +49 (0) 911 / 703 2221 • Fax: +49 (0) 911 / 703 2326 • Email: service@gss.de
Grundig SAT Systems GmbH • Beuthener Straße 43 • D-90471 Nürnberg

