

# Assembly Instructions

English



Grundig SAT Systems

## Head-End IP Converter to QAM MPTS to QAM

HMPT 1000 C



GSS  
Grundig SAT Systems GmbH  
Beuthener Strasse 43  
D-90471 Nuremberg

Phone: +49 (0) 911 / 703 8877  
Fax: +49 (0) 911 / 703 9210  
E-mail: [info@gss.de](mailto:info@gss.de)  
Internet: <http://www.gss.de>

<b>1</b>	<b>Safety regulations and notes</b> .....	<b>4</b>
<b>2</b>	<b>General information</b> .....	<b>5</b>
2.1	Packing contents.....	5
2.2	Meaning of the symbols used.....	5
2.3	Technical data.....	5
2.4	Description .....	6
	Input signal path "INROUTE" .....	7
	Menu setting "A=1 B=2".....	7
	Menu setting "A+B=1 2=OFF" .....	7
	Output signal path "OUTROUTE" .....	8
	Menu setting "1=>MA 2=>MB".....	8
	Menu setting "1=>ASI MA=OFF" .....	8
	Menu setting "2=>ASI MB=OFF" .....	8
	General.....	9
2.5	Software query.....	10
2.6	How the TPS module works.....	10
	Station filter .....	10
	Stuffing.....	10
	Changing the NIT.....	10
	Changing the operator ID (CAT) .....	10
2.7	Explanation of the term "symbol rate" .....	11
<b>3</b>	<b>Assembly</b> .....	<b>12</b>
3.1	Installing the cassette.....	12
3.2	EMC regulations.....	13
3.3	Cassette overview.....	14
3.4	Connecting the cassette .....	14
3.5	Retrofitting a CA module .....	15
<b>4</b>	<b>The control panel at a glance</b> .....	<b>16</b>
4.1	Menu items .....	16
4.2	Control panel.....	17
<b>5</b>	<b>Programming</b> .....	<b>17</b>
5.1	Preparation.....	17
5.2	Programming procedure.....	18
5.3	Programming the cassette .....	22
	Selecting the cassette, displaying the software version.....	22
	Ethernet parameters .....	23
	IP address of the cassette.....	23
	Address range .....	24

Address of the gateway.....	24
UDP port .....	24
Input signal path.....	25
Output signal path.....	25
ASI transfer rate .....	26
ASI options.....	26
Channel strip .....	27
Selecting channel / frequency setting.....	27
Output frequency, Output channel, Modulator.....	28
Output levels of the channel strips.....	29
Input data stream.....	29
IP reception, Transmission protocol, Port number .....	30
IP address of the input transport stream .....	31
Station filter .....	31
"INROUTE" menu setting "A = 1 B = 2".....	32
Test the status of the individual services: .....	33
"INROUTE" menu setting "A+B = 1 2 = OFF" .....	33
QAM modulation, Inverting the user signal .....	34
Setting the QAM modulation.....	34
Inverting the user signal.....	34
Output symbol range .....	35
Substitute signal in the case of an incorrect input signal .....	36
Transport stream / ORGNET-ID .....	36
Network Information Table (NIT).....	37
Network/operator identification .....	38
Deleting a PID .....	39
Renaming a PID.....	39
Factory reset .....	40
Saving settings .....	40
Tuner settings .....	41
LNB oscillator frequency.....	41
Input symbol rate, DVB mode.....	41
Input frequency .....	42
Testing the signal to noise ratio.....	43
Operation with a CA module .....	44
PID monitoring .....	44
CA module .....	44
Descrambling services.....	46
<b>6 Final procedures.....</b>	<b>47</b>
<b>7 Channel and frequency tables.....</b>	<b>48</b>

# 1 SAFETY REGULATIONS AND NOTES



- Assembly, installation and servicing should be carried out by authorised electricians.
- Switch off the operating voltage of the system before beginning with assembly or service work or pull out the mains plug.
- Do not perform installation and service work during thunderstorms.
- Install the system so it will not be able to vibrate...
  - in a dust-free, dry environment
  - in such a manner that it is protected from moisture, fumes, splashing water and dampness
  - somewhere protected from direct sunlight
  - not within the immediate vicinity of heat sources
  - in an ambient temperature of 0 °C to +50 °C. In case of the formation of condensation wait until the system is completely dried.
- Ensure that the head-end station is adequately ventilated. Do not cover the ventilation slots.
- Beware of short circuits
- No liability is accepted for any damage caused by faulty connections or inappropriate handling.
- Observe the relevant standards, regulations and guidelines on the installation and operation of antenna systems.
- The standards IEC/EN/DIN EN 50083 resp. IEC/EN/DIN EN 60728 must be observed.
- **For further information please read the assembly instructions for the head-end station used.**
- **Test the software versions of the head-end station and the cassette and update them if necessary. The current software versions can be found at "www.gss.de".**



**Take action to prevent static discharge when working on the device!**



**Electronic devices should never be disposed of in the household rubbish. In accordance with directive 2002/96/EC of the European Parliament and the European Council from January 27, 2003 which addresses old electronic and electrical devices, such devices must be disposed of at a designated collection facility. At the end of its service life, please take your device to one of these public collection facilities for proper disposal.**

## 2 GENERAL INFORMATION

### 2.1 PACKING CONTENTS

- 1 Cassette HMPT 1000 C
- 1 HF cable
- 1 Brief assembly instructions

### 2.2 MEANING OF THE SYMBOLS USED



Important note



General note



Performing works

### 2.3 TECHNICAL DATA

The devices meet the following EU directives:

2006/95/EC, 2004/108/EC

The product fulfils the guidelines and standards for CE labelling (page 49).

Unless otherwise noted all values are specified as "typical".

#### HF input

Frequency range: ..... 925 ... 2150 MHz

Level range: ..... 60 dB $\mu$ V ... 80 dB $\mu$ V

Return loss: ..... > 8 dB

DVB-S modes: ..... DVB-S  $1/2, 2/3, 3/4, 5/6, 7/8$

DVB-S2 modes: ..... QPSK  $1/2, 3/5, 2/3, 3/4, 4/5, 5/6, 8/9, 9/10$

8PSK  $3/5, 2/3, 3/4, 5/6, 8/9, 9/10$

Symbol rate DVB-S: ..... QPSK: 2 ... 45 MSymb/s

Symbol rate DVB-S2: ..... QPSK: 10 ... 30 MSymb/s

8PSK: 10 ... 31 MSymb/s

#### HF output

Channels: ..... S21 ... C69

Frequency range: ..... 42.0 MHz ... 860.0 MHz

Output level: ..... max. 96 dB $\mu$ V

Output impedance: ..... 75  $\Omega$

### LAN interface

Standard: ..... 100-BASE-T  
Data rate: ..... ≤ 80 MBit  
Protocols: ..... UDP (User Data Protocol),  
RTP (Real-Time Transport Protocol)

### ASI interface

Standard: ..... DIN EN 50083-9  
Format: ..... MPEG ISO IEC 13818-1  
User data rate: ..... 2 ... 90 Mbit/s  
Level (input / output): ..... 800 mV<sub>pp</sub> ± 10%  
Return loss (input): ..... > 17 dB (5 ... 270 MHz)

### Connections

SAT input: ..... 1 F socket  
HF output: ..... 1 IEC socket  
ASI output: ..... 1 BNC socket, 75 Ω  
Connection strip (10-pin): ..... for supply voltages and control circuits  
RS 232 socket: ..... serial interface for software update  
Conditional access: ..... 1 (several channels can be descrambled)

## 2.4 DESCRIPTION

The cassette is a "MPTS / QAM"-converter, which converts services (stations) modulated according to DVB-S / DVB-S2 standard and the data stream fed via the LAN interface into one or two QAM-modulated cable signals dependent on the input and output signal paths. The cassette has one SAT IF input and one HF output. Additionally it is equipped with a LAN interface and an ASI output (ASI – Asynchronous Serial Interface acc. DIN EN 50083-9).

The transport stream fed via the LAN socket can be inserted into the transport stream of the receiving stage via the TPS module. The signal path is set in the menu items input signal path "**INROUTE**" and output signal path "**OUTROUTE**".

## INPUT SIGNAL PATH "INROUTE"

### MENU SETTING "A=1 B=2"

The transport streams of the receiving stage channel strip "A" and of the LAN input channel strip "A" generate optionally the transport stream 1. The transport stream of the LAN input channel strip "B" generate the transport stream 2.

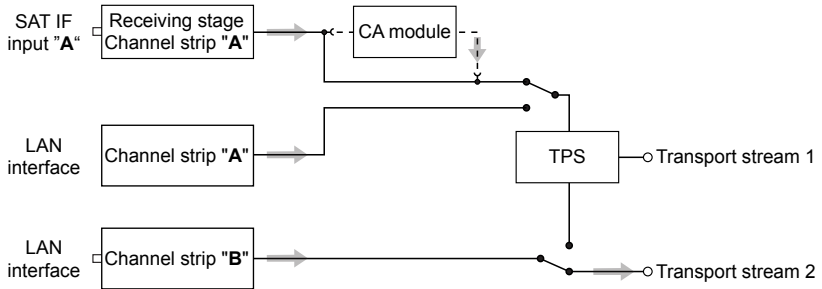

### MENU SETTING "A+B=1 2=OFF"

The transport streams of the receiving stage channel strip "A" and optionally of the LAN input channel strip "A" generate in conjunction with the transport stream of the LAN input channel strip "B" the transport stream 1. The transport stream 2 is switched off.

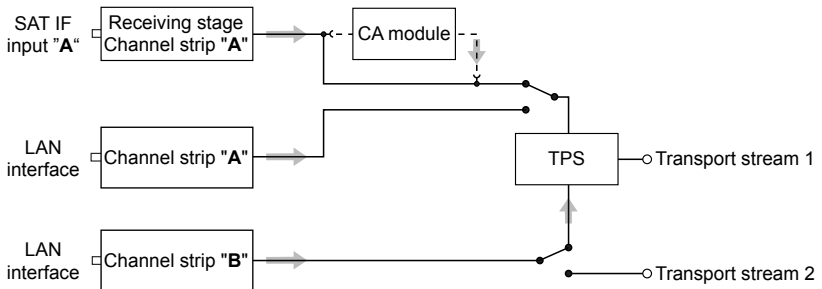

## OUTPUT SIGNAL PATH "OUTROUTE"

### MENU SETTING "1=>MA 2=>MB"

Transport stream 1 is made available via modulator "A", transport stream 2 via modulator "B".

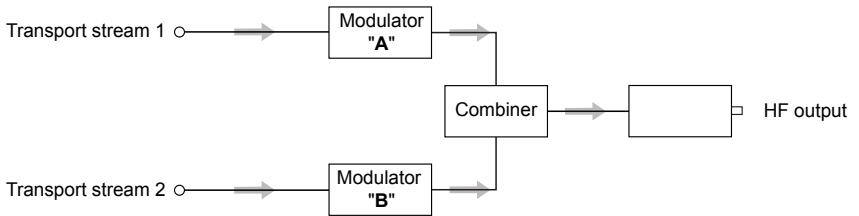

### MENU SETTING "1=>ASI MA=OFF"

Transport stream 1 is made available via the ASI output, transport stream 2 via modulator "B". The signal path via modulator "A" (MA) is switched off.

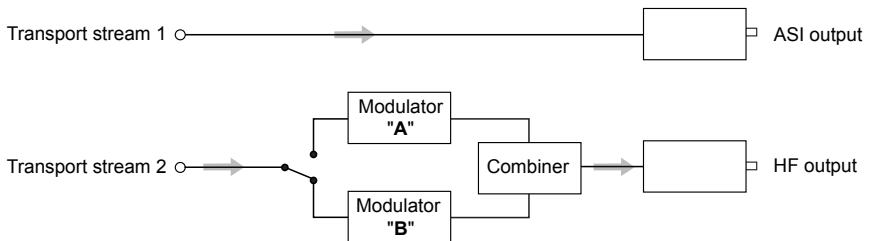

### MENU SETTING "2=>ASI MB=OFF"

Transport stream 1 is made available via modulator "A", transport stream 2 via the ASI output. The signal path via modulator "B" (MB) is switched off.

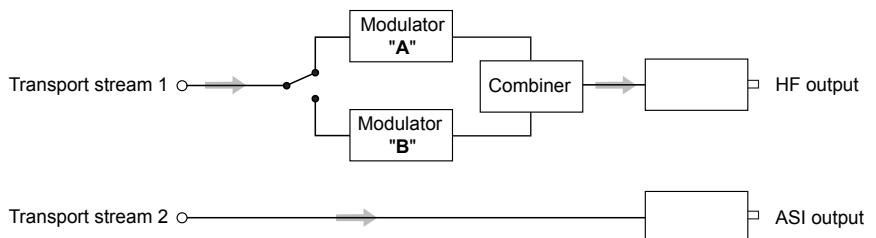



The cassette is equipped with two channel strips ("**A**" and "**B**"). The "**A**" channel strip has a digital SAT tuner and can process both the transport stream fed in via the LAN interface and the transport stream from the SAT tuner. Using an appropriate CA module, encoded services coming from the SAT tuner can be decoded in channel strip "**A**". The "**B**" channel strip only **processes** the transport stream fed in via the LAN interface. The transport streams are directed to the ASI output or the output converter depending on the set output signal route "**OUTROUTE**" via the digital signal processing levels. The HF output signals are sent through the HF output on the cassette to the output collector. The common output level of the channel strips can be set in the output collector on the head-end station.

An LED in channel strip "**A**" provides an indication of the signal quality for the SAT IF input signal and shows whether the modulator of the channel strip is activated (LED lights up) or deactivated. The quality of the transport stream being received is also shown in the display ("**CN...**").

The integrated TPS module (Transport Stream Processing) processes the data from the transport streams.

The channel strips are indicated in the head-end station display with "**Bx ...A**" and "**Bx ...B**". The control of the cassette takes place via the control unit of the head-end station.

When the head-end station is switched on, the two-line LC display shows the software version of the control unit.

To operate this cassette the software version of the control unit must be "**V 44**" or higher. You can find the current operating software for the control unit and the cassette, the software "**BE-Flash**" and the current assembly instructions on the website "**www.gss.de**".

The cassette is intended for use in the STANDARD LINE head-end stations.

## 2.5 SOFTWARE QUERY

### Control unit

If necessary, you can activate the indication of the software version of the control unit manually:

- Press any two keys on the control unit of the head-end station simultaneously until the display goes dark and the software version, e.g. "V 44" appears.

### Cassette

After activating the cassette the software version of the cassette is displayed (see. page 22).

## 2.6 HOW THE TPS MODULE WORKS

After decoding QPSK- or 8PSK-modulated signals, the demodulated data stream can be accessed via the integrated TPS module. This data stream, also called transport stream, contains several stations in all their components (video, audio, data and service information), which can be changed using the TPS module.

### STATION FILTER

Individual stations can be deleted. This reduces the data rate and, consequently, the output symbol rate required. Additionally stations of the different transport streams can be assembled to a new transport stream.

### STUFFING

The transport stream is padded using what is known as zero data. This ensures a steady and constant output symbol rate.

### CHANGING THE NIT

The transport stream contains data in the form of tables which the receivers evaluate and require for convenient use. The TPS module can adjust the "Network Information Table" (NIT) to accommodate the new station data. The "NIT" contains data which is required by the set-top box for the automatic search feature.

### CHANGING THE OPERATOR ID (CAT)

Some network operators transmit an operator ID in the data stream (e.g. visAvision). By changing the CAT the operator ID can be adjusted to the demands.

## 2.7 EXPLANATION OF THE TERM "SYMBOL RATE"

Modulation schemes such as QPSK and QAM transmit multiple bits simultaneously. These are referred to as symbols. In addition to the user data flow which transmits video and audio information, error correction bits are transferred. The FEC number states the ratio of user bits to the complete transmitted bits. The output symbol rate is calculated as follows:

$$256\text{-QAM: } \mathbf{SR (A)} = \text{FEC} \times 1/4 \times \text{SR (E)}$$

$$128\text{-QAM: } \mathbf{SR (A)} = \text{FEC} \times 2/7 \times \text{SR (E)}$$

$$64\text{-QAM: } \mathbf{SR (A)} = \text{FEC} \times 1/3 \times \text{SR (E)}$$

$$32\text{-QAM: } \mathbf{SR (A)} = \text{FEC} \times 2/5 \times \text{SR (E)}$$

$$16\text{-QAM: } \mathbf{SR (A)} = \text{FEC} \times 1/2 \times \text{SR (E)}$$

$$4\text{-QAM: } \mathbf{SR (A)} = \text{FEC} \times 1/1 \times \text{SR (E)}$$

### Example:

Output symbol rate 64-QAM,  $\text{FEC} = 3/4$ ,

Input symbol rate  $\text{SR (E)} = 27,500 \text{ kSymb/s}$

$$\mathbf{SR (A)} = 3/4 \times 1/3 \times 27,500 \text{ kSymb/s}$$

$$\mathbf{SR (A)} = 6,875 \text{ kSymb/s}$$

→ If no "FEC" is stated in the station lists, it can be assumed to be "FEC = 3/4".

### Reception from a transponder with a very low symbol rate (SCPC station)

The extremely low data rate means that the output symbol rate is very low. If there are reception problems with different digital receivers, set output symbol rate to a higher value.

### Defined symbol rates

Some cable operators specify a fixed symbol rate (e.g. 6,900 kSymb/s).

## 3 ASSEMBLY

### 3.1 INSTALLING THE CASSETTE



- Ensure the head-end station is mounted so it will not be able to vibrate. Avoid, for example, mounting the head-end station onto a lift shaft or any other wall or floor construction that vibrates in a similar way.
  - Before installing or changing a cassette unplug the power cable from the mains power socket.
- 
- Remove the fastening screws ① of an unoccupied slot from the bracket of the head-end station.
  - Insert the cassette in this slot and push it into the housing.
  - Align the cassette and apply slight pressure to connect it to the connections of the board and the HF bus bar.
  - Fasten the cassette with the screws ①.

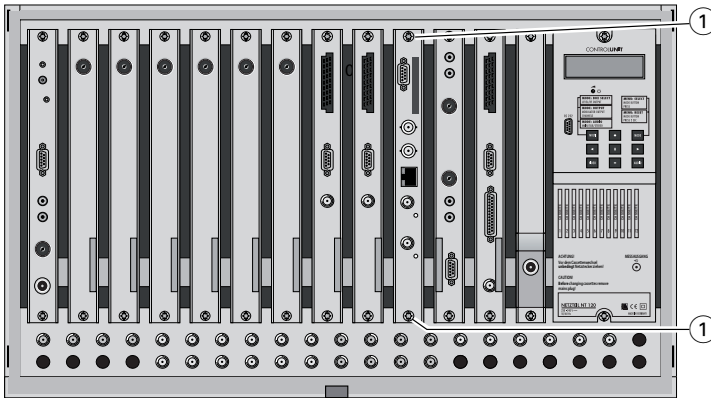

## 3.2 EMC REGULATIONS



To comply with the current EMC regulations, it is necessary to connect the lines leading in and out of the head-end station using cable terminals. When mounting the cassette in a head-end station which is installed in a 19" cabinet, make sure the connections leading in and out for the 19" cabinet are made using cable terminals.



The attenuation of shielding of the connection lines for ASI and antenna must meet the requirements for "Class A".

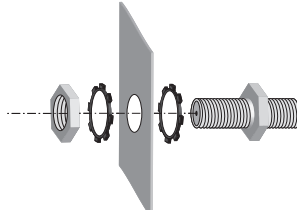

- Insert the required number of cable terminals in the openings provided in the head-end station or in the 19" cabinet.



Tighten the nut on the cable terminal until the teeth on the lock washer have penetrated the exterior coating and a good connection is made between the housing and cable terminal.

### 3.3 CASSETTE OVERVIEW

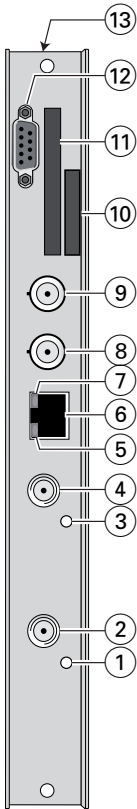

- ① Status LED of channel strip "B"
- ② Not used
- ③ Status LED of channel strip "A"
- ④ SAT IF input of channel strip "A"
- ⑤ Status LED of the LAN interface (data transfer)
- ⑥ LAN socket
- ⑦ Status LED of the LAN interface (network connection)
- ⑧ Not used
- ⑨ ASI output
- ⑩ Type label
- ⑪ Slot for a CA module
- ⑫ D-SUB socket "RS 232"
- ⑬ MAC address

The operating software of the cassette can be updated via the 9-pin D-SUB socket "RS 232" using a PC or notebook and the software "**BE-Flash**". You can find the current operating software on the website "[www.gss.de](http://www.gss.de)".

### 3.4 CONNECTING THE CASSETTE

- Connect the SAT IF input cable to the SAT IF input ④ (channel strip "A").
- Connect the LAN socket ⑥.
- Connect the ASI output ⑨ to the peripheral ASI device.

### 3.5 RETROFITTING A CA MODULE

The cassette is equipped with a common interface. It allows you to connect a CA module for various scrambling systems and service providers. Scrambled services (channels) can only be descrambled with a CA module suitable for the scrambling system and the corresponding smart card. The smart card contains all the information for authorisation, descrambling and subscription.



- Check with the distributor or manufacturer of the CA module to be used to ensure that it is suitable for descrambling several services.
  - **The hardware and software of this cassette have been thoroughly prepared and tested.**  
**Any changes made by service providers in the data structures might impair or even prevent this function.**
  - When working with the CA module, please read the corresponding operating manual from the respective provider.
- 
- Insert the smart card ① into the CA module ② so that the chip ③ on the smart card faces the thicker side (top) of the CA module.
  - Insert the CA module into the guide rails of the CA slot ④ with the top side of the CA module facing the top side of the cassette.
  - Push the CA module without canting into the guide rails of the CA slot ④ and contact it to the common interface.

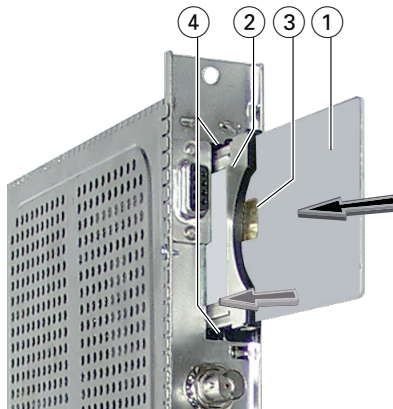

## 4 THE CONTROL PANEL AT A GLANCE

### 4.1 MENU ITEMS

Program the cassette using the buttons on the control unit of the head-end station. The two-line display of the control unit then shows the menus.

The parameters and functions to be set are underlined>.

Use the **MODE** key to select the following main menu items:

- Setting Ethernet parameters
- Input signal path
- Output signal path
- Channel strip
- Selecting channel / frequency setting
- Output channel / output frequency
- Output level
- Selecting the input
- IP parameters
- IP address of the input transport stream
- LNB oscillator frequency
- Input symbol rate
- Input frequency
- Station filter
- CA module (if available)
- QAM modulation
- Stuffing
- Substitute signal
- Transport stream / ORGNET-ID
- Network Information Table (NIT)
- Network/operator identification
- Deleting a PID
- Renaming a PID
- Factory reset

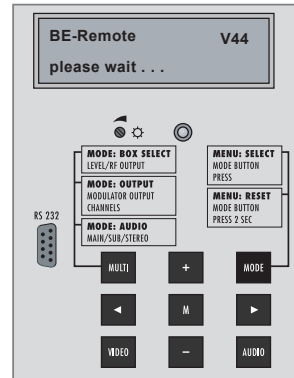



## 4.2 CONTROL PANEL

The key pad on the head-end station is used to scroll through the menus:

**MODE** scrolls forward through the menus.

**◀/▶** select parameters in the menus.

**+/-** set values, initiate actions.

**MULTI** selects sub-menus.

**AUDIO** scrolls backward through the menus.

**M** saves all entries.

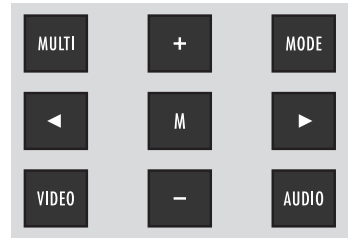

## 5 PROGRAMMING

### 5.1 PREPARATION

- Test the software versions of the head-end station and the cassette and update them if necessary. The current software versions can be found on the website "[www.gss.de](http://www.gss.de)".
- Connect the test receiver to the HF output or the test output of the head-end station.
- Set the output channel / output frequency of the cassette (page 28) and adjust the TV test receiver to this channel / this frequency.
- Switch on the channel strip "A" (modulator) if necessary (page 28). For the channel strip, there is a status LED which glows if the channel strip is switched on.

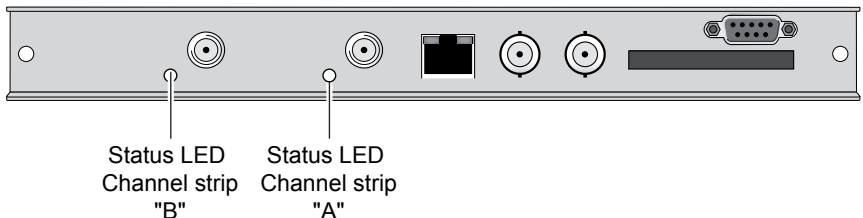

- Balance the output levels of the channel strips "A" and "B" if the difference in level is  $\geq 1$  dB (page 29).

## 5.2 PROGRAMMING PROCEDURE

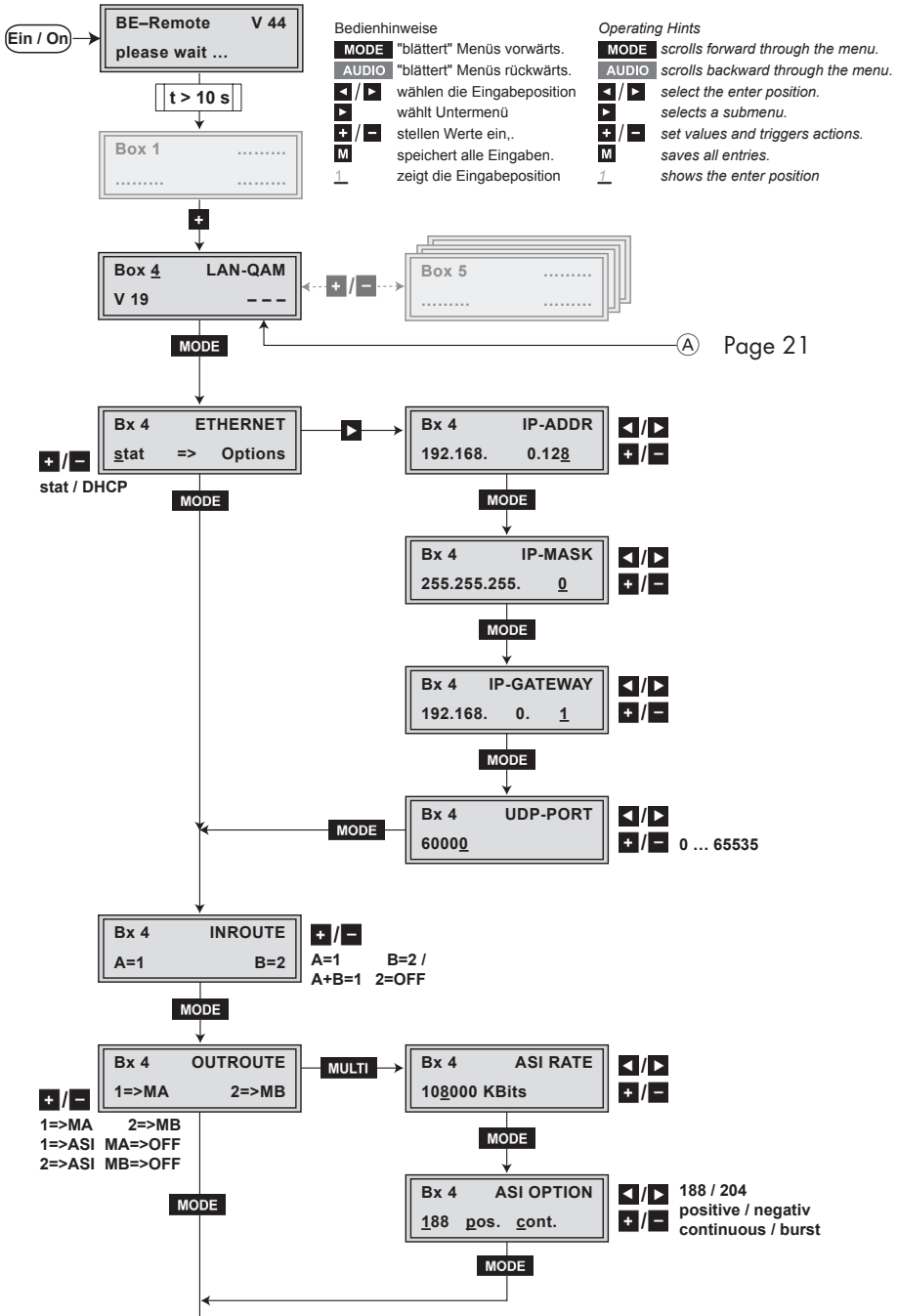

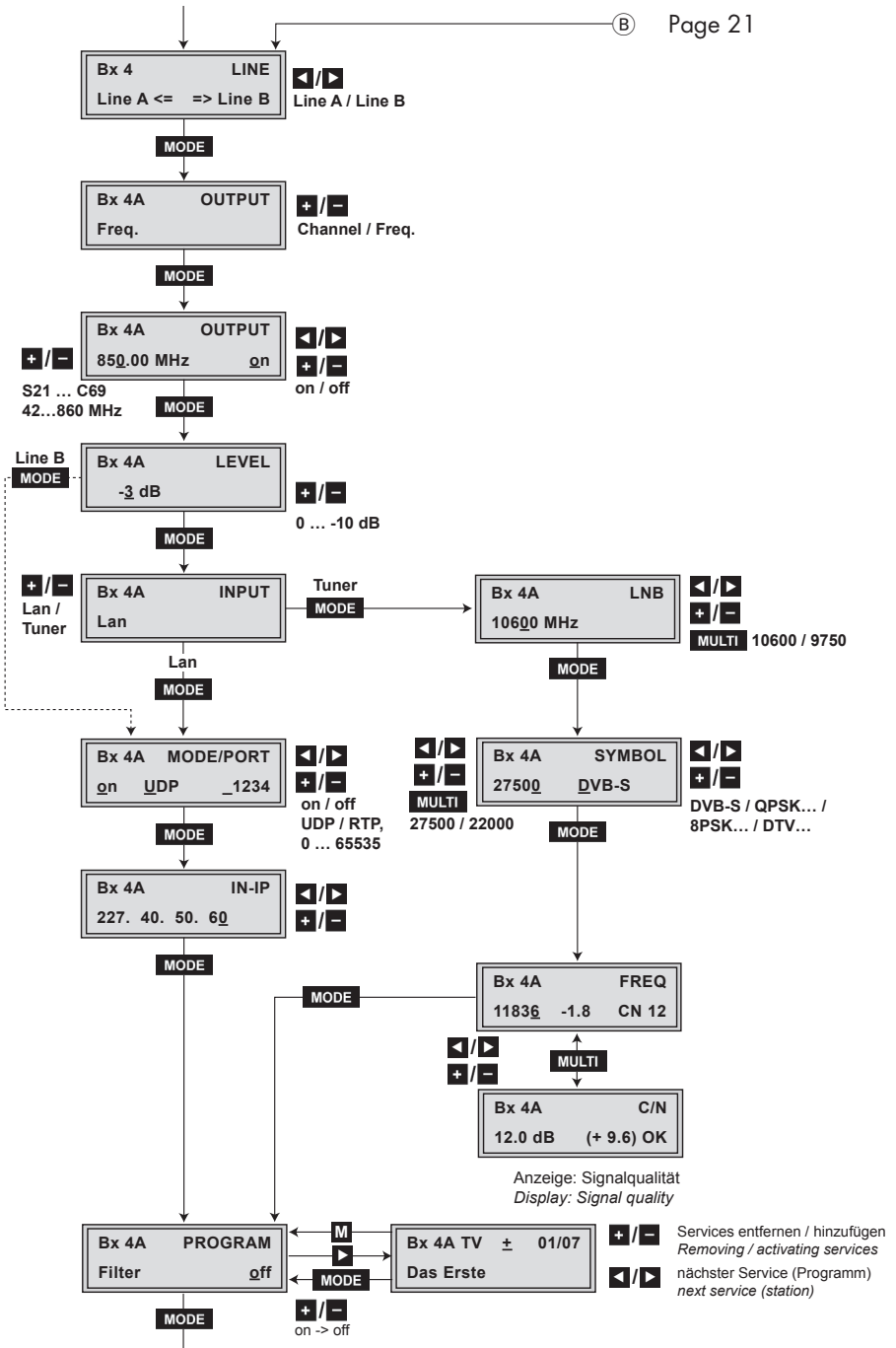

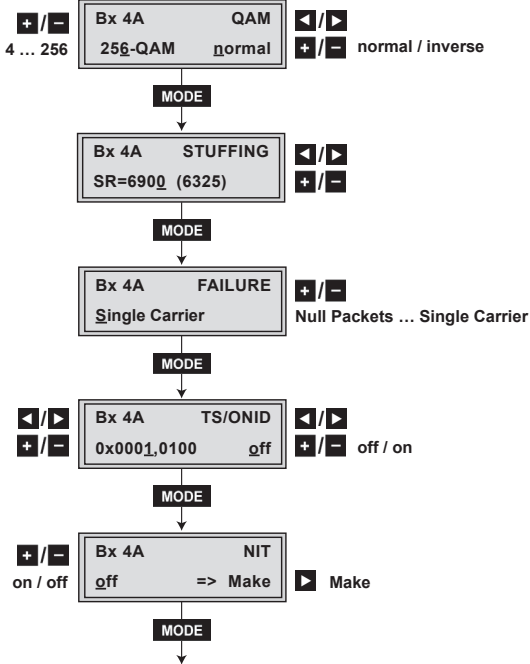
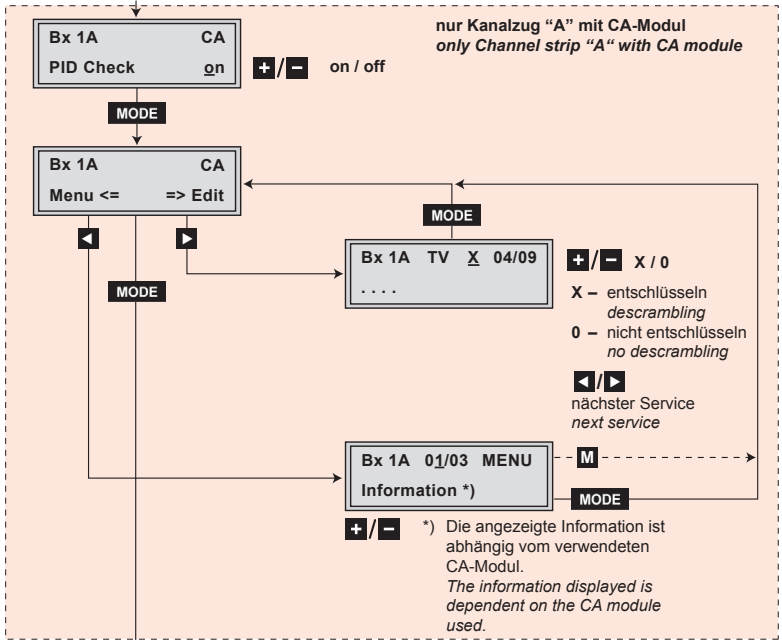

◀/▶ Bx 4A CAT-ID ▶/◀  
 +/- 0xDE00 off +/- on / off

MODE

◀/▶ Bx 4A DROP ▶/◀  
 +/- PID 0x0000 off +/- on / off

MODE

◀/▶ Bx 4A REMAP ▶/◀  
 +/- 0x0000 -> 0000 off +/- on / off

MODE

Bx 4A FACTORY  
 Defaults =>

Bx 4A FACTORY  
 STORE => M

auf Werkseinstellung  
 zurücksetzen und speichern  
 reset to factory defaults  
 and store

Page 18

Page 19

MODE

MODE

Ⓐ

Ⓑ

- Pressing the **MODE** button for longer than 2 seconds cancels the programming procedure. This takes you back to the programme item "Selecting the cassette" from any menu. Any entries that have not been saved are reset to the previous settings.
- Entries in the menus can be saved by pressing the **M** key. You are taken back to the "Selecting the cassette" menu item.
- The cursor position for settings is shown by "\_".

- Switch on the head-end station

- The display shows the software version (e.g. V 44)
- The processor reads the cassettes' data (approximately 10 seconds).

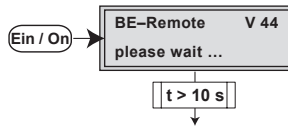

**SELECTING THE CASSETTE, DISPLAYING THE SOFTWARE VERSION**

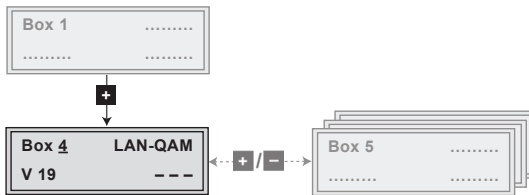

- Select the cassette you want to program (e.g. **Box 4**) by repeatedly pressing the buttons **+** / **-** if necessary.

- The display shows e.g. the menu **"Box 4 LAN-QAM V19"**:  
**"Box 4"** s stands for slot 4  
**"LAN-QAM"** Type of cassette  
**"V 19"** Software version of the cassette

- Press the **MODE** button.

- The "Ethernet parameters" – **"ETHERNET"** menu is activated.

## ETHERNET PARAMETERS

In this menu you specify whether the Ethernet parameters for the cassette are entered automatically by a connected server ("**DHCP**"), or whether you want to enter them manually ("**stat**"). To assign the cassette uniquely, each IPTV cassette must be allocated its own IP address.

Bx 4	ETHERNET
stat	=> Options

- Press the **+**/**-** buttons to select manual setting ("**stat**") or automatic setting ("**DHCP**") of the Ethernet parameters.
- Press the **▶** button to activate the setting options ("**Options**").

→ The "IP address of the cassette" – menu "**IP-ADDR**" is activated.

## IP ADDRESS OF THE CASSETTE

If you choose to enter the Ethernet parameters manually, set the IP address of the cassette in this menu. If "**DHCP**" is selected, the "**IP-ADDR**", "**IP-MASK**" and "**IP-GATEWAY**" sub-menus display the parameters that were assigned automatically by a connected server. If a server is not connected, " 0. 0. 0. 0\*" appears in the corresponding menu. The star " \* " in the display means that the data is provided by a DHCP server.

Bx 4	IP-ADDR
192.168.	0.128

- Use the **◀**/**▶** buttons to place the cursor under the digit of the IP address displayed to be set and use **+**/**-** to set the IP address wished.
- Press the **MODE** button.

→ The "Address range" – "**IP-MASK**" menu is activated.

## ADDRESS RANGE

In this menu you define the address range for the cassettes connected to the LAN network.

Bx 4	IP-MASK
255.255.255.	<u>0</u>

- Use the ◀/▶ buttons to place the cursor under the digit of the IP address displayed to be set and use +/− to set the IP address wished.
- Press the **MODE** button.

→ The "Address of the gateway" – **"IP-GATEWAY"** menu is activated.

## ADDRESS OF THE GATEWAY

The address of a gateway (server) can be set in this menu. If no gateway is used you can skip this setting.

Bx 4	IP-GATEWAY
192.168.	0. <u>1</u>

- Use the ◀/▶ buttons to place the cursor under the digit of the IP address displayed to be set and use +/− to set the IP address wished.
- Press the **MODE** button.

→ The "UDP port" – **"UDP-PORT"** menu is activated.

## UDP PORT

The UDP port setting is required if the cassette needs to be reached externally to make the setting, such as from another input frequency. This setting is intended for future functions and can be skipped for this cassette.

Bx 4	UDP-PORT
6000	<u>0</u>



- Use the **◀/▶** buttons to place the cursor under the digit of the port number displayed to be set and use **+/-** to set the port number wished ("0" ... "65535").
- Press the **MODE** button.

→ The "Input signal path" – "INROUTE" menu is activated.

### INPUT SIGNAL PATH

In this menu you define the signal path of the input transport streams.

Menu setting "A = 1 B = 2" (page 7).

Menu setting "A+B = 1 2 = OFF" (page 7).

Bx 4	INROUTE
A=1	B=2

- Use the **+/-** buttons to select the signal path wished.
- Press the **MODE** button.

→ The "Output signal path" – "OUTROUTE" menu is activated.

### OUTPUT SIGNAL PATH

In this menu you define the signal path of the output transport streams.

Menu setting "1 => MA 2 => MB" (page 8).

Menu setting "1 => ASI MA => OFF" (page 8).

Menu setting "2 => ASI MB => OFF" (page 8).

Bx 4	OUTROUTE
1=>MA	2=>MB

- Use the **+/-** buttons to select the signal path wished.
- If you do not want to do ASI settings, press the **MODE** button.

→ The "Channel strip" – "LINE" menu is activated (page 27).

- Press the **MULTI** button.

—> The "ASI transfer rate" – "**ASI RATE**" menu is activated.

## ASI TRANSFER RATE

In this menu you set the transfer rate for the ASI component connected. For this setting please take the required information from the documentation (technical data) of the ASI component to be connected.

Bx 4	ASI RATE
108000 KBits	

- Use the **◀/▶** buttons to place the cursor under the digits to be set for the transfer rate then use the **+/-** buttons to set the transfer rate wished.
- Press the **MODE** button.

—> The "ASI options" – "**ASI OPTION**" menu is activated.

## ASI OPTIONS

In this menu you define the size of the data packets, their polarity and the type of transmission.

For this setting please take the required information from the documentation (technical data) of the ASI component to be connected.

Bx 4	ASI OPTION
188 pos. cont.	

- Press the **+/-** buttons to set the size of the data packets ("**188**" or "**204**" bits).
- If the polarity of the data to be transmitted has to be changed, press the **◀/▶** buttons to place the cursor under "**pos.**" (positive – standard) and using the **+/-** buttons set to "**neg.**" (negative).

- To change the type of transmission press the ◀/▶ buttons to position the cursor under "**cont.**" (continuous – standard) and using the +/– set to "**burst**".

—> Setting "**cont.**"

The data packets of the user data are collected to a great data packet in the transport stream.

—> Setting "**burst**"

The data packets of the user data are spaced out evenly in the transport stream.

- Press the **MODE** button.

—> The "Channel strip" – "**LINE**" menu is activated.

## CHANNEL STRIP

Bx 4	LINE
Line A <=	=> Line B

- By pressing ◀ select channel strip "**A**" ("**Line A**") or select channel strip "**B**" ("**Line B**") by pressing the ▶ button.

—> The "Selecting channel / frequency setting" – "**OUTPUT**" menu is activated.

## SELECTING CHANNEL / FREQUENCY SETTING

In this menu, you can choose the channel or frequency setting for the adjustment of the HF output. The channel setting covers the range of channels S21 ... C69, the frequency setting covers the range from 42.0 MHz to 860.0 MHz.



The QAM signal is normally transmitted with a bandwidth of 8 MHz. This means that you can only use the channel centre frequency of the existing channel grid in the range of channels S21 ... C69 (frequency grid 8 MHz). The CCIR channel grid is 7 MHz in the range of the lower frequency bands (channels C2 ... S20). Therefore the frequency setting is used here. If one uses the existing channel grid of 7 MHz in these channel ranges, this will result in

interference (overlapping) with the 8 MHz QAM signal packages, thus causing transmission problems.

For programming in these channel ranges and in the frequency ranges below them, we recommend starting with channel S21 / 306 MHz going back in steps of 8 MHz (see frequency table on page 48), or reducing the bandwidth of the QAM output signal by removing stations.

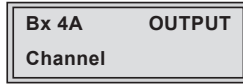

- Use **+**/**-** to select channel setting "**Channel**" or frequency setting "**Freq.**".
- Press the **MODE** button.

→ The "Output channel" or "Output frequency" – "**OUTPUT**" menu is activated.

#### OUTPUT FREQUENCY, OUTPUT CHANNEL, MODULATOR

In this menu, dependent on the setting before, you set the output frequency (42.0 ... 860.0 MHz) or the output channel (S21 ... C69) of the channel strip. Additionally the modulator of the channel strip can be switched off or on.

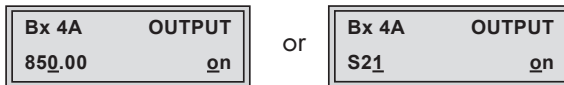

- Use the **◀**/**▶** buttons to position the cursor under the digit to be set for the frequency or channel display then use **+**/**-** to set the desired output frequency or channel.
- To switch off the modulator place the cursor under "**on**" using the **▶** button and switch "**off**" the modulator of the channel strip using the **+**/**-** buttons.

→ The switched off modulator is indicated by " - - - " in the display.

- If the modulator is switched "**off**" use the **+**/**-** to switch it "**on**".
- Press the **MODE** button.

→ The "Output levels of the channel strips" – "**LEVEL**" menu is activated.

## OUTPUT LEVELS OF THE CHANNEL STRIPS

This menu item is used to set the output levels of the modulators of the channel strips "A" and "B" to the same value.



- Measure and note down the output level of the channel strip.
- By repeatedly pressing the **AUDIO** button scroll back to the "Selecting the channel strip" menu.
- Select the other channel strip (page 27) and set the following menu items:
  - "Selecting channel / frequency setting", page 27.
  - "Setting the output channel" or "Setting the output frequency", page 28.
  - Switch on the modulator if necessary, page 28.
  - Measure and note down the output level.
- Activate the "LEVEL" menu of the channel strip with the higher output level.
- By pressing **+**/**-** adjust the higher output level of one channel strip to the lower output level of the other channel strip incrementally from "0" to "-10 dB".
- Press the **MODE** button.

—> Channel strip "A":

The "Selecting the input data stream" – "INPUT" menu is activated.

—> Channel strip "B":

The "Switching the IP address off or on, selecting the transmission protocol, setting the port number" – "MODE / PORT" menu is activated (page 29).

## INPUT DATA STREAM

In this menu you select the signal source for the selection of the services. The transport streams to be processed are provided by the tuner of channel strip "A" and the LAN interface "Lan".



- Press the **+/−** buttons to select the signal source of the input transport stream ("**Lan**", "**Tuner**").
- Press the **MODE** button.

→ Setting "**Lan**":

The "IP reception, Transmission protocol, Port number" – "**MODE / PORT**" menu is activated.

→ Setting "**Tuner**":

The "LNB oscillator frequency" – "**LNB**" menu is activated. Continue with chapter "Tuner settings", page 41.

## IP RECEPTION, TRANSMISSION PROTOCOL, PORT NUMBER

In this menu you can switch off or on the IP address of the transport stream fed via the LAN interface and define the transmission protocol and the port number. These settings are not necessary in the channel strip "**B**" if "**A+B=1 2=OFF**" is set in the "**INROUTE**" menu.

Bx 4A	MODE/PORT
on	UDP _1234

### Switching the IP address off or on

- Press the **+/−** buttons to switch "**off**" or "**on**" the IP address of the transport stream fed via the LAN interface, if necessary.

### Selecting the transmission protocol

- Press the **▶** button to position the cursor under "**UDP**" or "**RTP**".
- Using the **+/−** buttons to select the transmission protocol wished:
  - "**UDP**" – The User Datagram Protocol is for the connectionless transmission of data to a certain application. The port number of the service is also sent which the data should obtain.
  - "**RTP**" – The Real-time Transport Protocol is for continuously transmitting multimedia data streams in an IP network. Unlike UDP, the header is transmitted which makes the data transmission more robust.

### Setting the port number

- Press the **▶** button to position the cursor under the port number e.g. "**\_1234**".
- Use the **◀/▶** buttons to position the cursor under the digit of the port number displayed to be set.

- Using the **+**/**-** buttons set the port number wished.
- Press the **MODE** button.

→ The "IP address of the input transport stream" – "**IN-IP**" menu is activated.

## IP ADDRESS OF THE INPUT TRANSPORT STREAM

In this menu you can set the IP address of the transport stream fed via the LAN interface.

Bx 4A	IN-IP
227. 40. 50. 6 <u>0</u>	

- Use the **◀**/**▶** buttons to position the cursor under the digit of the IP address displayed to be set.
- Using the **+**/**-** buttons set the IP address wished.
- Press the **MODE** button.

→ The "Station filter" – "**PROGRAM**" menu is activated.

## STATION FILTER

The default setting for the station filter is "**off**". In this menu you define the services received to be transmitted. If services are activated the output symbol rate increases.

If the station filter is switched off (factory default) all services of the transport stream passes the station filter. As soon as the station filter is activated all services are inactive and can be added to the transport stream selectively.

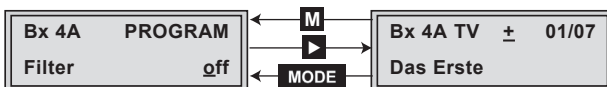

The figures of the menus below are dependent on the setting of the "Input signal path" menu (page 25).

## "INROUTE" MENU SETTING "A = 1 B = 2"

- Press the **+/-** button.

- All services from the channel strip will be read, and then displayed with name and type of the service.
- If no service is found, the following message will appear in the display: "**FILTER no Service**".  
In this case, check the configuration of the antenna system and the head-end station, as well as the previously adjusted settings for the cassette and the components connected to the LAN input.
- The display shows e.g.:



Bx 4A TV ± 01/07  
Das Erste

### Meaning of the indicators in the example:

"Bx 4A"	Slot 4, channel strip "A"
"TV"	"Television" (type of service)
" + "	The currently selected service is activated.
"01/07"	The 1st of 7 services is being displayed.
"Das Erste"	Name of the service

### Further possible terms displayed:

"RA"	"Radio" (type of service) For radio stations, the background of the screen of the connected TV or test receiver is darkened.
" - "	The currently selected service is switched off.
" * "	A star means that the service selected is encoded. To enable the service, the CA module and the appropriate smart card of the provider are required.

- If a service number (e.g. "**131**") appears instead of "**TV**" or "**RA**", this indicates that an unnamed service or an undefined data stream is being received.

- Use the **◀/▶** buttons to call up the services in sequential order, then use **+/-** to activate (indicated by " + ") or to remove them (indicated by " - ").

- Pressing the **MULTI** button all services can be activated or deactivated.



- Press the **MODE** button.

- > The filter is activated.  
The display shows **"PROGRAM Filter on"**.
- > If services are activated the corresponding PIDs (audio, video, text) are inserted into the transport stream and the PAT and SDT tables are updated.

#### TEST THE STATUS OF THE INDIVIDUAL SERVICES:

- If the filter is switched on, press the **▶** button. In this mode you can test the settings of the station filter again or change them if necessary.
- In the **"PROGRAM Filter on"** menu the station filter switched on can be switched **"off"** using the buttons **+ / -** if necessary.

#### "INROUTE" MENU SETTING "A+B = 1 2 = OFF"

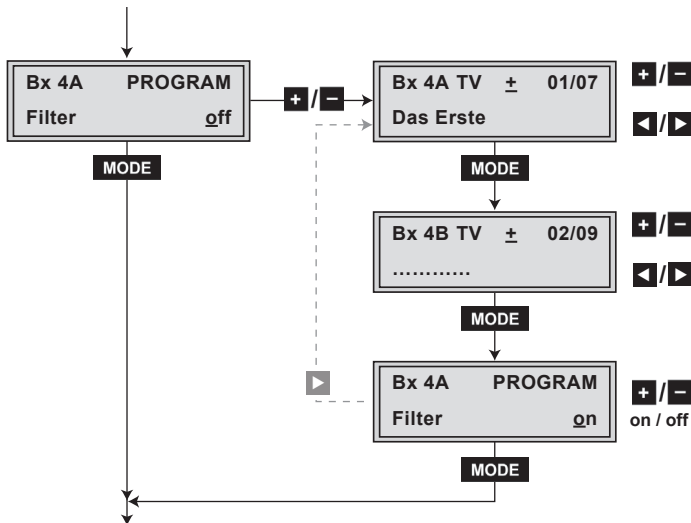

- Set the channel strip **"A"** or **"B"**.

- > The setting of the station filters for the channel strips **"A"** and **"B"** is identical and follows the description above.

- Press the **MODE** button.

—> The "QAM modulation, inverting the user signal" – "**QAM**" menu is activated.

Programming the channel strip "**A**" with a CA module installed the "PID monitoring" – "**CA**" menu is activated (page 44).

## QAM MODULATION, INVERTING THE USER SIGNAL

In this menu, you can set the QAM modulation and for exceptional cases and "older" digital cable receivers invert the spectral position of the user signal "**inverse**".

Bx 4A	QAM
64-QAM	<u>n</u> ormal

## SETTING THE QAM MODULATION

- Use **+**/**-** to set the QAM modulation ("**4**" ... "**256**").

—> For higher QAM modulation, the output symbol rate is lowered. An output QAM modulation of > 64 QAM places a large burden on the cable network. Due to noise, delay and frequency response problems, reception of the converted output signal can be impeded.

## INVERTING THE USER SIGNAL

- Use the **◀**/**▶** buttons to place the cursor under "**normal**".
- Use **+**/**-** to set the spectral position to "**inverse**".
- Press the **MODE** button.

—> The "Output symbol rate" – "**STUFFING**" menu is activated.

In this menu, you can modify the output symbol rate.

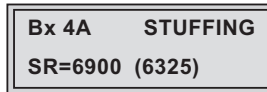

Zahl 1      Zahl 2

**SR=6900** (= "Number 1"): Active output symbol rate

**(6325)** (= "Number 2"): The current measured output symbol rate.

If the station filter is activated, this value is lower than the value of the "Number 1". The value fluctuates, since the data rates of individual services are dynamically modified by the broadcasters.

- Use the / buttons to place the cursor under the number to be changed ("Number 1") and set the symbol rate with the buttons / . The value set corresponds to the new output symbol rate.

### Increasing the value of "Number 1".

- The "Number 1" can be increased to any value up to 7500.
- Using values > 6950 you exceed the bandwidth of a 8 MHz frequency grid.

### Reducing the value of "Number 1".

- With the station filter switched "on", the "Number 1" can be decreased. To do this, observe the "Number 2" for approx. 30 seconds and note the highest value. Add roughly 10 % to this value. Do not decrease the "Number 1" lower than the value of "Number 2". Is the "Number 1" lower than "Number 2" question marks "??" appear in the display.

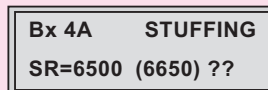

- Press the **MODE** button.

- The "Substitute signal in the case of an incorrect input signal" – "FAILURE" menu is activated.

## SUBSTITUTE SIGNAL IN THE CASE OF AN INCORRECT INPUT SIGNAL

You use this menu to set whether a QAM signal filled with "**Null Packets**", a QAM signal filled with null packets and self-made tables "**Tables**" or a "**Single Carrier**" signal should be provided as an output signal whenever an incorrect input signal occurs. Self-made tables are transmitted furthermore.

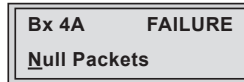

- Use the **+**/**-** buttons to set the output signal required.
- Press the **MODE** button.

→ The "Transport stream/ORGNET-ID" – "**TS/ONID**" menu is activated.

## TRANSPORT STREAM / ORGNET-ID

If the stations of a transponder are split into the transport streams of the channel strips "**A**" and "**B**", one of the both transport streams a new identification must be allocated to realise the channel search of the settop boxes connected without mistakes.

If the ORGNET-ID is changed a new NIT must be generated (page 37).

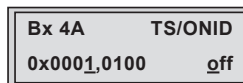

- Use the **◀**/**▶** buttons to position the cursor under the digit of the hexadecimal number to be set.
- Press **+**/**-** to set the respective digit of the hexadecimal number.
- Repeat the procedure by the quantity of the digits to be set.
- Using the **▶** button place the cursor under "**off**" and switch "**on**" the transmitter identification using the **+**/**-** buttons.

→ By pressing the **◀** button you return to the hexadecimal number setting.

- Press the **MODE** button.
- The "Network Information Table" – "**NIT**" menu is activated.

Bx 4A	NIT
<u>off</u>	=> Make

- To switch NIT on/off ("on"/"off") press the **+** / **-** buttons.
- Press the **▶** button to activate NIT "**Make**".



- All active cassettes which are able to output a NIT ("NIT cassettes") must be set and ready for reception.
- The NITs of all "NIT cassettes" are switched on.
- The cassette fetches all the information (output frequencies, output data rates, etc.) it needs from all the "NIT cassettes" in order to generate the NIT. This process may take a few seconds. Then the NIT is generated, added and sent to all "NIT cassettes". The other "NIT cassettes" also add this new NIT. The status of all "NIT cassettes" in the NIT menu changes to "**on**". The display shows: "**read ... / copy ...**".

- To switch off the new NIT ("**off**") press the **-** button.



- The NITs of the other "NIT cassettes" will stay switched on. When the NIT of the cassette is switched on again ("**on**") by pressing the **-** button, the previously generated NIT is added again. If you have changed parameters in the meantime, you must first select "**Make**" to generate a new, up-to-date NIT.

- Press the **MODE** button.

- The "Network/Operator identification" – "**CAT-ID**" menu is activated.

## NETWORK/OPERATOR IDENTIFICATION

In this menu, you can change the network/operator identification (CAT-ID – Conditional Access Table - Identification), for example of the visAvision transponder (Eutelsat 8° West).

Bx 4A	CAT-ID
0xDE00	off

### CAT is not to be changed.

- Press the **MODE** button.

—> The "Deleting a PID" – "**DROP**" menu is activated (page 39).

### CAT is to be changed.

The network operator e.g. requires that you set the operator ID of the visAvision transponder to "2".

- Use the **◀/▶** buttons to position the cursor under the digit to be set.
- Use **+/-** to change the operator ID from "**0xDE00**" to "**0xDE02**".
- Use the **▶** button to position the cursor under "**off**," then use **+/-** to activate the new CAT "**on**".

—> The menu display switches to "**modified**".

—> If you try to change the network/operator identification (operator ID) of a transponder which cannot be modified, "**not modified**" appears in the display.

- Press the **MODE** button.

—> The "Deleting a PID" – "**DROP**" menu is activated.

## DELETING A PID

In this menu a PID of the transport stream can be deleted.

Bx 4A	DROP
PID 0x0000	off

- Use the ◀/▶ buttons to place the cursor under the respective digit of the hexadecimal number of the PID to be deleted ("0x0000") and set the hexadecimal number using +/-. .
- Use ▶ to set the cursor to "off" and switch to "on" (delete) using the +/- buttons.
- Press the **MODE** button.

—> The "Renaming a PID" – "REMAP" menu is activated.

## RENAMING A PID

In this menu you can allocate a new address to a PID retaining the complete data content.

Bx 4A	REMAP
0x0000 -> 0000	off

- Use the ◀/▶ buttons to place the cursor under the respective digit of the hexadecimal number of the PID to be changed ("0x0000") and set the hexadecimal number using +/-. .
- Use the ◀/▶ buttons to place the cursor under the respective digit of the hexadecimal number of the new PID ("-> 0000").
- Set the hexadecimal number using +/-. .
- Use ▶ to set the cursor to "off" and switch to "on" (rename) using the +/- buttons.
- Press the **MODE** button.

—> The "Factory reset" – "FACTORY Defaults" menu is activated.

## FACTORY RESET

In this menu you can reset all settings to the factory defaults.

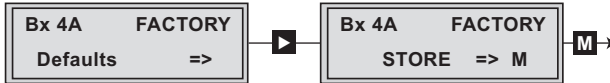

- Press the **▶** button.

—> The factory defaults are invoked ("FACTORY STORE").  
—> By pressing the **MODE** button, you will be returned to the menu item "Channel strip" **without** invoking the factory defaults (page 27).

- Press the **M** button.

—> The factory defaults are saved. The display shows "STORE"  
—> Back to "Selecting the cassette" (page 22).  
—> By pressing the **MODE** button, you will be returned to the menu item "Channel strip" **without** saving the factory defaults (page 27).  
—> If necessary set channel strip "B".

## SAVING SETTINGS

- Press the **M** button.

—> The settings are saved.  
—> You will be returned to the menu item "Selecting the cassette" (page 22).  
—> If functions of the TPS module are activated, their status is shown in the second line of the display:  
"M" – Station filter is switched on.  
"N" – NIT is activated.  
"C" – Network/operator identification CAT is activated.  
—> If necessary set channel strip "B".



## TUNER SETTINGS

### LNB OSCILLATOR FREQUENCY

Set the oscillator frequency of the LNB used in this menu.



- Using the **MULTI** button the oscillator frequencies "10600" or "9750" can be selected directly.
- To set other LNB oscillator frequencies use the ◀/▶ buttons to place the cursor under the digit of the LNB oscillator frequency displayed to be set.
- Press +/- to enter the respective digit of the oscillator frequency of the LNB used.
- Repeat the procedure by the quantity of the digits to be set.
  
- Press the **MODE** button.

→ The "Input symbol rate, DVB mode" – "**SYMBOL**" menu is activated.

### INPUT SYMBOL RATE, DVB MODE

The symbol rates of the satellite transponders can be found in the current channel table of the satellite operator, in various satellite magazines and in the Internet.

The cassette recognizes the transmitted DVB mode and switches over between the normal QPSK mode (DVB-S) and the DVB-S2 mode. Receiving stations with DVB-S2 mode, we suggest to preset the DVB mode to shorten the time for searching stations.

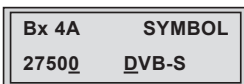

#### Setting the input symbol rate

- Using the **MULTI** button the symbol rates "27500" or "22000" can be selected directly.
- To set other symbol rates use the ◀/▶ buttons to position the cursor under the digit of the symbol rate displayed to be set.
- Press +/- to enter the respective digit of the symbol rate needed.
- Repeat the procedure by the quantity of the digits to be set.

## Setting the DVB mode

- Use the **▶** button to place the cursor under "**DVB-S**" and set the required DVB-S2-mode with the buttons **+**/**-**.
- Press the **MODE** button.

→ The "Input frequency" – "**FREQ**" menu is activated.

## INPUT FREQUENCY

If three dots " ... " appear in the second line of the display, the cassette is in the "**station search**" mode. Please wait until the process has finished.

Once the HF receiver has synchronised to the input signal, any offset to the target frequency is displayed in MHz, e.g. "**- 1.8**" in the middle of the second line of the display.

If a question mark "?" appears in the second line of the display, there is no input signal present. Check the configuration of the antenna system and head-end station as well as the preceding settings of the cassette.

<b>Bx 4A</b>	<b>FREQ</b>
<b>11836</b>	<b>-1.8 CN 12</b>

- Use **◀**/**▶** to position the cursor under the digit to be set of the frequency displayed.
- Press **+**/**-** to set the input frequency.
- Set the frequency offset shown in the display (e.g. "**- 1.8**") to less than 1 MHz by varying the input frequency using the **+**/**-** buttons.

→ The "**CN 12**" display e.g., indicates the signal to noise ratio of the signal received.

- Press the **MULTI** button.

→ The "Signal to noise ratio" – "**C/N**" menu is activated.

## TESTING THE SIGNAL TO NOISE RATIO

In this menu you can estimate the quality of the input signal.

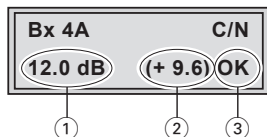

- ① Current signal to noise ratio
- ② This value shows the difference between the quality of the input signal and the threshold of the tuner at this type of modulation.  
At a value lower than "5" picture dropouts can occur.



- ③ If "OK" is shown, the signal to noise ratio is ok.  
If a value < 5 is shown under ② the display changes from "OK" to "??".  
In this case check the input signal.

→ In addition to the indicator in the display, there is also a status LED which indicates the quality of the received transport stream.

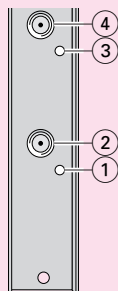

③ Status-LED Tuner A

LED indicator	Indication
Green	Signal quality is good
Yellow	Signal quality is insufficient
Red	No signal
Off	The channel strip (modulator) is switched off

- Press the **MULTI** button to return to the main menu.
- Press the **MODE** button.

→ The "Station filter" – "PROGRAM" menu is activated.

Continue with the programming procedure as described from page 31 on.

## OPERATION WITH A CA MODULE

In order for this function of the CA module to be possible, stations / services capable of being descrambled by the CA module and the smart card you are using must be selected in the "Station filter" – "**PROGRAM**" menu of channel strip "**A**" (page 31).

Where both scrambled and unscrambled services are transmitted via a single channel, short-term picture loss may occur when switching between scrambled and unscrambled services.

## PID MONITORING

The factory default of the PID monitoring is switched on. If particular PIDs are not descrambled the CI module is reset. Additionally dropouts may occur if several services are descrambled. To prevent this the PID monitoring can be switched off.

Bx 4A	CA
PID Check	on

- Use the **+**/**-** buttons to switch "**off**" or "**on**". the PID monitoring.
- Press the **MODE** button.

—> The "CA module" – "**CA**" menu is activated.

## CA MODULE

The menu varies according to which CA module you are using. For this reason, please refer to the operating manual of your particular CA module. The relevant information is shown in the display of the head-end station. This may appear as a fixed display or as scrolling text according to display capabilities.

Bx 4A	CA
Menu <=	=> Edit

—> By pressing the **MODE** button you can skip the "Configuring the CA module" – "**CA**" menu and activate the "QAM modulation" – "**QAM**" menu (page 34).

- Press the **◀** button to activate the menu of the CA module.

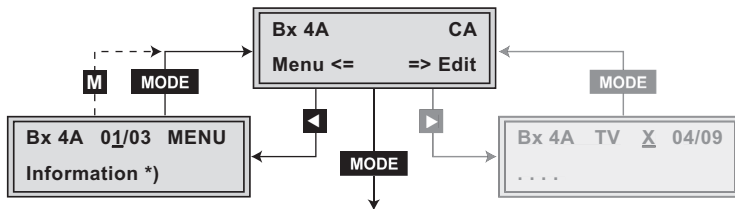

→ The display shows e.g.: **Bx 4A 01/03 MENU**  
**Information**

**Meaning of the indicators:**

- "Bx 4A" Slot 4, channel strip "A"
- "01/03" The first of three menu items is activated.
- "MENU" The menu of the CA module is activated.

For the explanation of further details please use the operating instructions of the CA module used.

- Use the **+/-** buttons to activate the menu desired.
- Press the **▶** button to activate the menu.
- Use the **+/-** buttons to select the function desired.
- To set the CA module use the **◀/▶** and **+/-** buttons.
- All settings are saved by pressing the **M** button.

→ You will be returned to the "CA module" – "**CA**" menu item.

→ By pressing the **MODE** button you can cancel the settings in the menu of the CA module and are returned to the "CA module" – "**CA**" menu.

- Press the **▶** button.

→ The "Descrambling services" – "**Edit**" menu is activated.

## DESCRAMBLING SERVICES

In this menu you select the services wished from the scrambled data stream, which are to be descrambled.

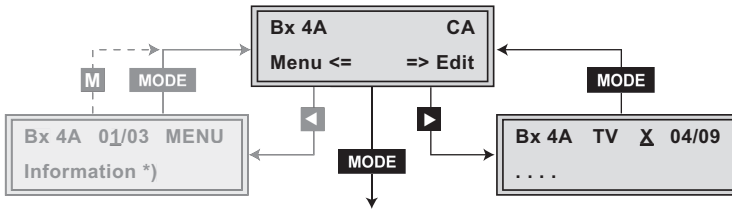

→ The display shows e.g.: **Bx 4A TV X 04/09**

....

### Meaning of the indicators in the example:

"Bx 4A"	Slot 4, channel strip "A"
"TV"	"Television" (type of service)
"X"	Descrambling is set for the currently selected station.
"04/09"	The 4th of 9 services is being displayed.
". . . ."	Name of the service

### Further possible terms displayed:

"RA"	"Radio" (type of service)
"0"	The currently selected service remains unchanged.

- Use the **◀/▶** buttons to call up the services in sequential order which are to be descrambled, then use **+/-** to descramble ("X") or not to descramble them ("0").
- Press the **MODE** button to save changes and activate the filter.

→ The filter is activated. The display shows the "CA module" – "CA" menu.



- Press the **MODE** button.

→ The "QAM modulation" – "QAM" menu is activated (page 34).



**After installing the head-end station, upgrading accessories or installing cassettes it is necessary to tighten all cable connections, cable terminals and cover screws in order to maintain compliance with current EMC regulations securely.**

- Securely tighten the cable bolted connections fingertight using an appropriate open-ended spanner.
- Measure the output levels of the other cassettes and tune them to a uniform output level using the appropriate level controls or software dependent on the head-end station used. Please regard the assembly instructions of the respective head-end station.

—> In order to prevent interference within the head-end station and the cable system, the output levels of the digital cassettes must be set lower by 8 dB compared to analogue cassettes.

- Mount the front cover (see assembly instructions of the head-end station).

## 7 CHANNEL AND FREQUENCY TABLES

### Advice for a frequency grid (8 MHz) in the Band I/III

Frequenzraster Frequency grid [MHz]	Frequenzraster Frequency grid [MHz]	Frequenzraster Frequency grid [MHz]	Frequenzraster Frequency grid [MHz]	Frequenzraster Frequency grid [MHz]	Frequenzraster Frequency grid [MHz]
42.00	82.00	146.00	186.00	226.00	266.00
50.00	114.00	154.00	194.00	234.00	274.00
58.00	122.00	162.00	202.00	242.00	282.00
66.00	130.00	170.00	210.00	250.00	290.00
74.00	138.00	178.00	218.00	258.00	298.00

### CCIR – Hyperband (Frequency grid 8 MHz)



Kanal Channel	Kanalmitteffrequenz Channel centre frequency [MHz]	Kanal Channel	Kanalmitteffrequenz Channel centre frequency [MHz]	Kanal Channel	Kanalmitteffrequenz Channel centre frequency [MHz]	Kanal Channel	Kanalmitteffrequenz Channel centre frequency [MHz]
S 21	306.00	S 26	346.00	S 30	378.00	S 34	410.00
S 22	314.00	S 27	354.00	S 31	386.00	S 35	418.00
S 23	322.00	S 28	362.00	S 32	394.00	S 36	426.00
S 24	330.00	S 29	370.00	S 33	402.00	S 37	434.00
S 25	338.00						
						S 38	442.00
						S 39	450.00
						S 40	458.00
						S 41	466.00

### CCIR – Band IV/V (Frequency grid 8 MHz)

C 21	474.00	C 31	554.00	C 41	634.00	C 51	714.00	C 61	794.00
C 22	482.00	C 32	562.00	C 42	642.00	C 52	722.00	C 62	802.00
C 23	490.00	C 33	570.00	C 43	650.00	C 53	730.00	C 63	810.00
C 24	498.00	C 34	578.00	C 44	658.00	C 54	738.00	C 64	818.00
C 25	506.00	C 35	586.00	C 45	666.00	C 55	746.00	C 65	826.00
C 26	514.00	C 36	594.00	C 46	674.00	C 56	754.00	C 66	834.00
C 27	522.00	C 37	602.00	C 47	682.00	C 57	762.00	C 67	842.00
C 28	530.00	C 38	610.00	C 48	690.00	C 58	770.00	C 68	850.00
C 29	538.00	C 39	618.00	C 49	698.00	C 59	778.00	C 69	858.00
C 30	546.00	C 40	626.00	C 50	706.00	C 60	786.00		



# Declaration of CE conformity

	<b>Konformitätserklärung</b> <b>Declaration of Conformity / Déclaration de Conformité</b> 091/ 09	<b>CE</b>
Der Hersteller/Importeur The manufacturer/importer Le producteur/importateur	<b>GSS GRUNDIG SAT-Systems GmbH</b>	
Anschrift / Address / Adresse	<b>Beuthener Straße 43, D-90471 Nürnberg, Germany</b>	
erklärt hiermit eigenverantwortlich, daß das Produkt: declare under their sole responsibility that the product: / déclare, que le produit:		
Bezeichnung / Name / Description	<b>SAT - Kassette</b>	
Type / Model / Type	<b>GSS HMPT 1000 C</b>	
Bestell-Nr. / Order-No. / N° de réf.	<b>GAS 1230</b>	
folgenden Normen entspricht: is in accordance with the following specifications: / correspond aux normes suivantes:		
	<b>EN 50083-2:</b>	<b>2006</b>
	<b>EN 60065 :</b>	<b>2002</b>
	<b>EN 60065 + A1 :</b>	<b>2006</b>
Das Produkt erfüllt somit die Forderungen folgender EG-Richtlinien: Therefore the product fulfils the demands of the following EC-Directives: Le produit satisfait ainsi aux conditions des directives suivantes de la CE:		
<b>2006/95/EG</b>	<b>Richtlinie betreffend elektrische Betriebsmittel zur Verwendung innerhalb bestimmter Spannungsgrenzen</b> <b>Directive relating to electrical equipment designed for use within certain voltage limits</b> <b>Directive relatives au matériel électrique destiné à être employé dans certaines limites de tension</b>	
<b>2004/108/EG</b>	<b>Richtlinie über die elektromagnetische Verträglichkeit</b> <b>Directive relating to electromagnetic compatibility</b> <b>Directive relatives à la compatibilité électromagnétique</b>	
Nürnberg, 13. August 2009		
	 Michael Bierschneider Leiter Entwicklung Manager Development / Directeur Développement	

**Service:**

Phone: +49 (0) 911 / 703 2221  
Fax: +49 (0) 911 / 703 2326  
Email: [service@gss.de](mailto:service@gss.de)