

Assembly Instructions

English

GSS
Grundig SAT Systems GmbH
Beuthener Strasse 43
D-90471 Nuremberg

Phone: +49 (0) 911 / 703 8877
Fax: +49 (0) 911 / 703 9210
E-mail: info@gss.de
Internet: <http://www.gss.de/en>





Grundig SAT Systems

Head-End Station

STC 816 R



1	Notes about safety and hazards	4
2	General information	6
2.1	Meaning of the symbols used	6
2.2	Scope of delivery	6
2.3	Available accessories	6
2.4	Technical data	7
2.5	Description	8
3	Overview	9
3.1	Front cover	9
3.2	Connectors and components	9
	Front view / side view (type label)	9
	View from below	10
	Rear view	10
3.3	Control unit	11
	Power supply units	11
4	Installing the head-end station	12
4.1	Remove front cover	12
4.2	Mounting the head-end station	12
	Wall mounting	13
	Mounting in a 19" cabinet	14
5	Installing a cassette	15
6	Connecting the head-end station	16
7.1	Potential equalisation (PE)	16
6.2	EMC regulations (electromagnetic compatibility)	16
6.3	Connecting RF output of the head-end station	17
6.4	Power supplies/Mains connection	17
	Operating status indicators, alarm tone	18
	Replacing a power supply	18
	Internal power supplies	19
	LNB power supply	19
	Connecting peripheral devices	19
7	Setting the contrast of the display	20
8	The control panel at a glance	21
8.1	Control panel	21
8.2	Menu items	21

9	Updating the software of the control unit.....	22
9.1	Updating software via PC.....	22
9.2	Updating the software via second control unit.....	22
	Removing master control unit.....	22
	Programming slave control unit.....	23
	Inserting master control unit.....	24
11	Programming.....	24
11.1	Preparation.....	24
10.2	Programming procedure.....	25
	Message after temperature exceeding.....	26
10.3	Programming the head-end station.....	27
	Activating system information.....	28
	System information – control unit.....	28
	Perform settings.....	28
	Call up information about the head-end station.....	28
	System information – output collector.....	29
	System information – temperature.....	29
	System information – number of the head-end station.....	30
	System information – clock frequency.....	30
	Setting the RF output level of the cassettes.....	30
	Setting the RF output level of the head-end station.....	31
	Setting the consecutive number of the head-end station.....	31
	Activating the modem connection.....	32
	Setting the password.....	32
	Saving settings.....	33
	Programming the head-end station (following excess temperature).....	33
	System information.....	34
10.4	Programming via the control software.....	35
	 Redundant Power Supply.....	35
	Restart the cassettes of a station (reset).....	36
	 Station configuration.....	37
11	Final procedures.....	38

1 NOTES ABOUT SAFETY AND HAZARDS



- The head-end station is subject to the regulations of protection class I.
- Never operate the device without a protective earth connection, earth connection to the device and potential equalisation!
- Observe the relevant VDE regulations.
- **If the power cord needs to be replaced, only use an OEM power cord (EMC).**
- The standards EN/DIN EN 50083 resp. IEC/EN/DIN EN 60728 must be observed, especially concerning equipotential bonding and earthing.
- Observe the relevant standards, regulations and guidelines on the installation and operation of antenna systems.
- Before starting installation or service work disconnect the receiving system from mains. For a complete disconnection from the mains, the mains plug must be pulled out of the mains socket. Ensure that the mains plug can be pulled out without difficulties.
- Do not perform installation and service work during thunderstorms.
- Assembly, installation and servicing must be carried out by an authorised electrician.



- **The head-end station should only be installed in a room where the permissible ambient temperature range (0 °C and +50 °C) can be maintained, even during fluctuations in climatic conditions.**
- **Make sure there is a minimum space**
 - at wall mounting 50 cm above and below
 - at mounting in a 19" cabinet 20 cm above and below, as well as 10 cm behind.
- **To avoid too strong heating of the head-end stations it is not admissible to mount them one upon the other without using thermic precautions (e.g. permanently air recirculation, ventilation, heat deflectors etc.).**
- If additional fans are to be used to circulate the air, ensure that the system will be shut down (disconnected from mains) should any one of the fans fail.
- Install the head-end station
 - in a dry, dust-free environment
 - in such a manner that it is protected from moisture, fumes, splashing water and dampness
 - where it is protected from direct exposure to sunlight
 - on a vibration-free wall or floor construction
 - not within the immediate vicinity of heat sources
- In case of the formation of condensation wait until the system is completely dried.
- Ensure that the head-end station is adequately ventilated.

- Do not cover the ventilation openings!
- Do not install the head end in cabinets or recesses which are not ventilated.
- Do not place any vessels containing liquids on the head-end station.
- Do not place anything on the head-end station which could initiate fires (e.g. candles).
- Due to the risk of fires caused by lightning strikes, we recommend that all mechanical parts (e.g. distributor, equipotential bonding rail, etc.) be mounted on a non-combustible base. Wood panelling, wooden beams, plastic covered panels and plastic panels are all examples of combustible bases.
- Avoid short circuits!
- To ensure electromagnetic compatibility, make sure all connections are tight and that the covers are screwed on securely.
- No liability is accepted for damage caused by faulty connections or inappropriate handling of the device.
- You can obtain additional information from the "Planning handbook" brochure which can be found on the website "<http://www.gss.de/en>" under the "**Service**" category.



Electronic devices should never be disposed of in the household rubbish. In accordance with directive 2002/96/EC of the European Parliament and the European Council from January 27, 2003 which addresses old electronic and electrical devices, such devices must be disposed of at a designated collection facility. At the end of its service life, please take your device to one of these public collection facilities for proper disposal.

2 GENERAL INFORMATION

2.1 MEANING OF THE SYMBOLS USED



Important note



Performing works



Danger by electrical shock



General note

2.2 SCOPE OF DELIVERY

1 STC 816 R head-end station (without cassettes)

1 DVD (assembly instructions)

1 Brief assembly instructions

2 Power cords

2.3 AVAILABLE ACCESSORIES

For cassettes and accessories see website "www.gss.de/en".

2.4 TECHNICAL DATA

The devices meet the following EU directives:
2006/95/EC, 2004/108/EC, 2011/65/EU

The product fulfils the guidelines and standards for CE labelling (page 39).

Unless otherwise noted all values are specified as "typical".

General

Cassette slots:	8
Admissible ambient temperature:	0 °C ... +50 °C
Dimensions (W x H x D) [mm]:	483 x 410 x 302
Mounting dimensions (W x H x D) [mm]:	483 x 620 (14 HE/HU) x 302 incl. free space to replace the power supply
Weight (fully equipped):	approx. 20 kg
LNB operating voltage:	+12 V / ≤1 A = total (short-circuit-proof)
Other operating voltage:	+12 V / ≤1 = A total (not short-circuit-proof, use with appropriate external fuse only)
RS 232 socket: ... data interface for software update and remote maintenance	

RF output collector

Frequency range:	45 ... 860 MHz
Control range of each input:	0 ... -25 dB (electronically)
Control range of each output:	0 ... -6 dB (electronically)
Input, output impedance:	75 Ω
Return loss:	14 dB
RF output:	F socket
Decoupling loss of the inputs:	30 dB
Insertion loss (due to internal amplifier):	0 dB
Output level with 16 channels	maximum 93 dBμV

Power supply

Mains voltage:	220–240V~, 50/60 Hz
Power supplies (individually hot swappable):	2
Power consumption (fully equipped, incl. LNB power supply):	210 W

2.5 DESCRIPTION

The head-end station has a modular structure and can hold up to 8 Standard cassettes. You can find a list of the current Standard cassettes at the website "www.gss.de/en". This head-end station is designed exclusively for use with cassettes of the Standard marketing programme. The various expansion options for the head-end station allow for the installation of a wide range of broadband cable systems.

The redundant power supply consisting of 2 complete power supplies in half-load operation, enables e.g. a UPS and mains operation or a 2-phase operation. Both power supplies are individually hot swappable. In case of failure of a power supply, a warning tone sounds. One LED per power supply lights green during fault-free operation and red when the output voltage is faulty or overheating / a fan failure is present. The head-end station is designed to supply power to components (e.g. LNBs) connected upstream. The head-end station's power supply unit can be used to supply peripheral devices with voltage (+12 V / max. 1 A \equiv , with an external fuse).

By retrofitting two input distributors, 2x2 SAT IF inputs can be distributed to 2 x (4 + 6) outputs.

The cassettes' RF output signals are accumulated in a programmable RF output collector and then directed to the RF output. When the head-end station is shipped from the factory, the default setting for the RF output level of the output collector is -3 dB. You can use the software of the control unit to program the master output level of the head-end station.

The software version of the control unit appears on the two-line LC display after switching on the head-end station. The display also supports dialogue guidance when programming the head-end station. Use the buttons of the control unit to programme the head-end station. You can also use the PSW 1000 software and the HRCU 8 / RCU 1 management unit to programme the head-end station.

The RS 232 interface of the control unit enables you to use a PC or a notebook and the "**BE-Flash**" software to update the operating software of the control unit. You can find the current operating software for the control unit, the software "**BE-Flash**" and the current assembly instructions on the website "www.gss.de/en".

If the inner temperature of the head-end station exceeds the permissible temperature of 65 °C when operating, a message appears in the display instead of the standby menu. This message contains the maximum measured temperature and the number of the head-end station.

3 OVERVIEW

3.1 FRONT COVER

Fig. 1

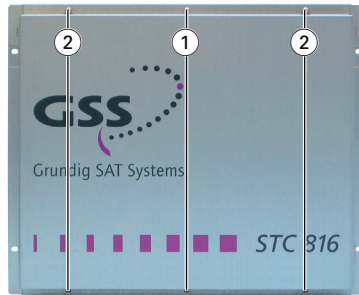

① Locking screws

② Mounting screws

—> To maintain compliance with the EMC regulations, the head-end station must not be operated without this front cover.

3.2 CONNECTORS AND COMPONENTS

FRONT VIEW / SIDE VIEW (TYPE LABEL)

Fig. 2

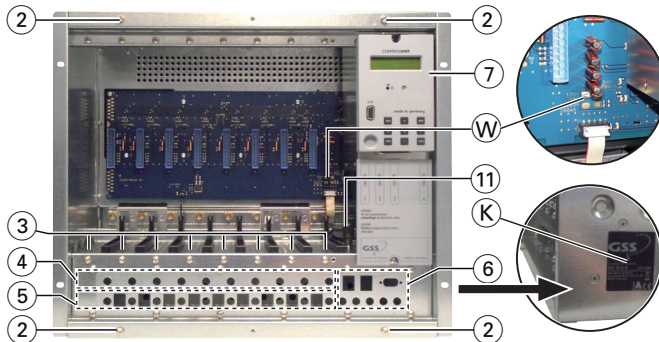

② Mounting screws for front cover

③ Cassette slots 1 ... 8

④...⑥ Cover for cable terminals

—> To maintain compliance with the EMC regulations, the head-end station must not be operated without this cover.

—> The rectangular openings are affected to mount RJ45 cable terminals.

- ④ Openings for SAT IF input distributor
- ⑤ Openings for SAT IF input distributor or LAN terminals
- ⑥ Openings for cable terminals
- ⑦ Control unit
- Ⓜ Connector for peripheral devices (+12 V / max. 1 A ==)
- Ⓚ Type label

VIEW FROM BELOW

Fig.3

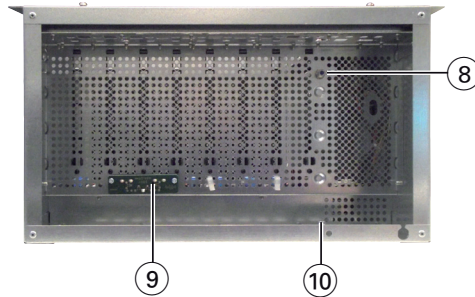

- ⑧ RF output of the head-end station
- ⑨ Distributor for LNB operating voltage
- ⑩ Potential equalisation screw

REAR VIEW

Fig.4

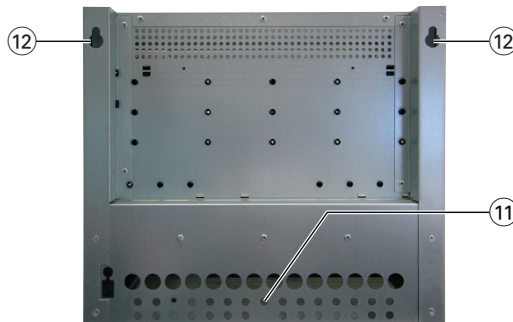

- ⑪ Opening for the securing screw
- ⑫ Openings for mounting screws (wall mounting)

3.3 CONTROL UNIT

Fig.5

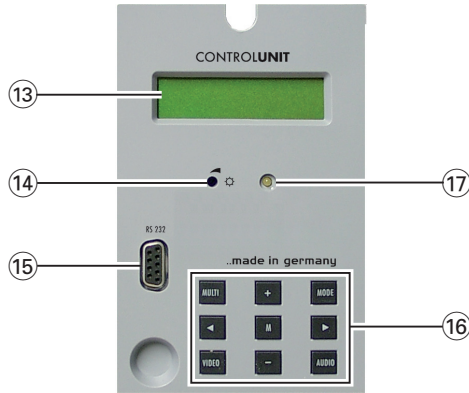

- ⑬ LC display
- ⑭ Control to set the contrast of the LC display.
- ⑮ 9-pin D-SUB socket to update the operating software, to connect the HRCU 8 / RCU 1 management unit.
- ⑯ Control buttons (control panel)
- ⑰ Standby voltage indicator

POWER SUPPLY UNITS

Fig.6

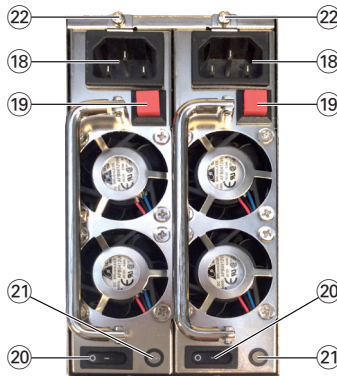

- ⑱ Socket for mains cable
- ⑲ Reset button
- ⑳ On/off switch
- ㉑ Operating voltage indicator (LED)
- ㉒ Locking screw

4 INSTALLING THE HEAD-END STATION

4.1 REMOVE FRONT COVER

Fig.7

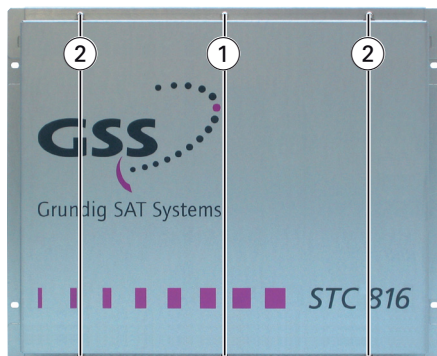

- Unscrew the locking screws ①.
- Loosen the mounting screws ②.
- Slide the front cover upwards and unhook it.

4.2 MOUNTING THE HEAD-END STATION



- Install the head-end station vibration-free. Avoid, for example, mounting the head-end station onto a lift shaft or any other wall or floor construction that vibrates in a similar way.
- **To avoid too strong heating of the head-end stations it is not admissible to mount them one upon the other without using thermic precautions (e.g. permanently air recirculation, ventilation, heat deflectors etc.).**
- Ensure that
 - the mounting area can support the weight of the head-end station
 - there is an adequate ventilation
 - the permissible ambient temperature will be maintained
 - the mounting position is dry and protected against splashing water.

—> For a complete disconnection from the mains, the mains plug must be pulled out of the mains socket. Ensure that the mains plug can be pulled out without difficulties.

- > Use mounting material suitable for the **wall properties**.
- > Position the head-end station so that the distance of free space below and above is **minimum 50 cm**.
- > The distance of the upper holes is **413 mm**.

Fig.8

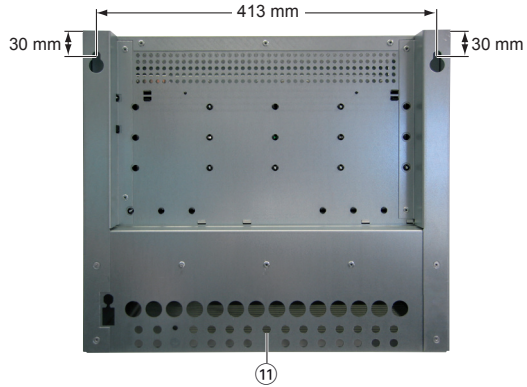

- Screw in the upper mounting screws at the position wished, mount the head-end station and mark the position for the locking screw (11).
- Remove the head-end station and attach the hole for the locking screw.
- Mount the head-end station and fix it with the locking screw (11).

MOUNTING IN A 19" CABINET

The head-end station has been designed for installation into 19" rack systems.

—> The total installation height incl. the free space to change a power supply unit is 14 HU (62 cm, hole spacing 26.5 cm).

⚠ In cabinets a circular aeration (e.g. by means of ventilators) is to be ensured. If the **maximum ambient temperature inside the cabinet exceeds +50 °C**, a thermo switch with reclose inhibition must automatically disconnect the system from the mains power supply.

- Position the head-end station in the cabinet so that there is a minimum free space of 20 cm above and below, as well as 10 cm behind.

Fig.9

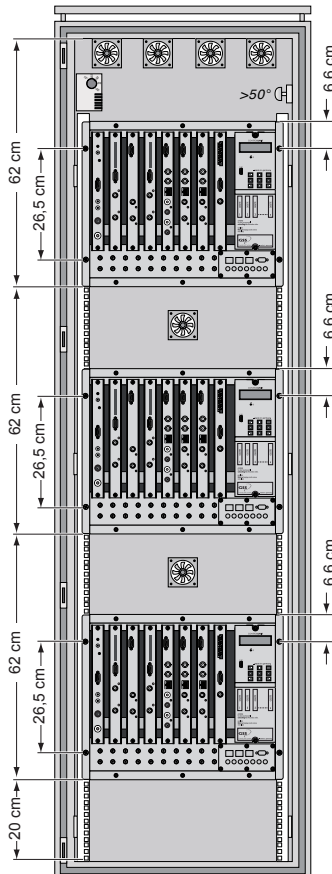

5 INSTALLING A CASSETTE



Before installing or changing a cassette unplug the power cable of the head-end station from the mains power socket.

Fig.10

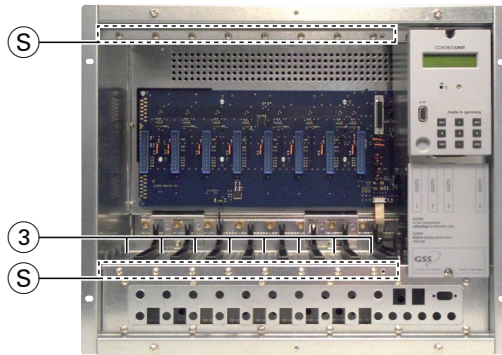

- Remove the fastening screws (S) of an unoccupied slot (3) from the bracket of the head-end station.
- Insert the cassette in this slot and push it into the housing.
- Align the cassette according to the connections in the board and the RF collector and press it firmly into place in the head-end station.
- Fasten the cassette with the screws (S).

6 CONNECTING THE HEAD-END STATION

7.1 POTENTIAL EQUALISATION (PE)



Equalise the potential (PE) in accordance with IEC/EN/DIN EN 60728.

Fig.11

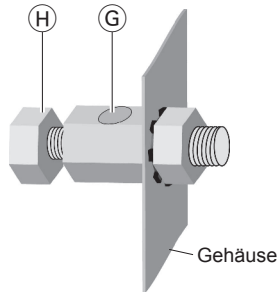

- Put the PE wire (Cu 4 mm² - 20 mm²) into the hole (G) of the PE connection terminal (10) (fig. 13, page 17) and fasten the PE wire with the screw (H) securely.
- Connect the PE connection terminal to a PE rail (supplied by customer) using the PE wire.

6.2 EMC REGULATIONS (ELECTROMAGNETIC COMPATIBILITY)



To comply with the current EMC regulations, it is necessary to connect the lines leading in and out of the head-end station (e.g. Cinch, RF) using standard cable terminals.

Fig.12

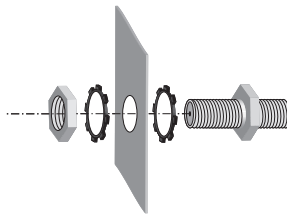

- According to figure 8 insert the required number of standard cable terminals in the openings provided in the front of the head-end station (fig. 2 (4)...(6), page 9).



Tighten the nuts on the cable terminals until the teeth on the lock washers have penetrated the exterior coating and a good connection is made between the housing and the cable terminals.

→ To maintain compliance with the EMC regulations, the head-end station must not be operated without the front cover.

6.3 CONNECTING RF OUTPUT OF THE HEAD-END STATION

Fig.13

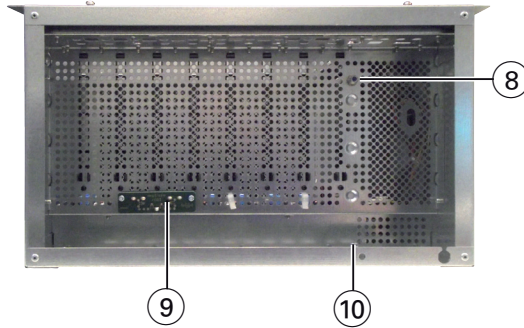

- Connect the RF output of the hybrid amplifier (8) to the cable system.

6.4 POWER SUPPLIES/MAINS CONNECTION



Use only the mains cables supplied. They are part of the approval and must only be replaced by an original spare part.

Fig.14

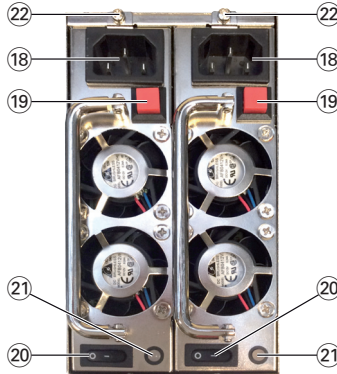

- Connect both power supplies (18) via the attached power cords to mains sockets.

—> By the two standby power supplies the control unit is supplied with voltage.



For a complete disconnection from the mains, the mains plug (18) must be pulled out.

- Switch on the two power supply units by the on/off switches (20).

→ At an error free operation the two operating status indicators (21) will light green.

OPERATING STATUS INDICATORS, ALARM TONE

LED (21)	State
green	error free operation
red	<ul style="list-style-type: none"> - voltage faulty - overtemperature - defect/blocked fan
off	<ul style="list-style-type: none"> - switched off - no function/defective

If one power supply is defective or switched off, an alarm tone sounds until the reset button (19) is pressed (Fig. 14, page 17).

In addition, the following message is displayed:

POWER SUPPLY !!
(DC) fault !!!

If both power supplies are defective or switched off, the following message is displayed:

POWER SUPPLY !!
(AC/DC) fault !!!

→ The alarm tone and the fault indicators can only be emitted as long as the standby voltage is present.

REPLACING A POWER SUPPLY

A power supply can be replaced during operation (hot swap).

- Remove the mains cable (18) (Fig. 14, page 17).
- Remove the locking screw (22) (Fig. 14, page 17).
- Take the handle and pull the power supply upwards out of the housing.

INTERNAL POWER SUPPLIES

LNB POWER SUPPLY

The LNB power supply (+ 12 V / max. 1 A \Rightarrow) is done via the connectors \textcircled{Y} of the power distributor (Fig. 15).



The total output current for all LNBs connected must not exceed 1 A.

Fig.15

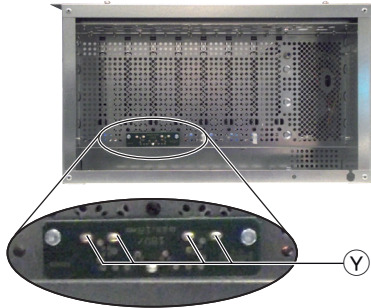

CONNECTING PERIPHERAL DEVICES

Via connector \textcircled{W} (Fig. 2, page 9) peripheral devices can be supplied with power (+12 V / max. 1 A \Rightarrow).



Connect peripheral devices exclusively via external fuses!

7 SETTING THE CONTRAST OF THE DISPLAY

- Adjust the contrast of the display using the controller ⑭.

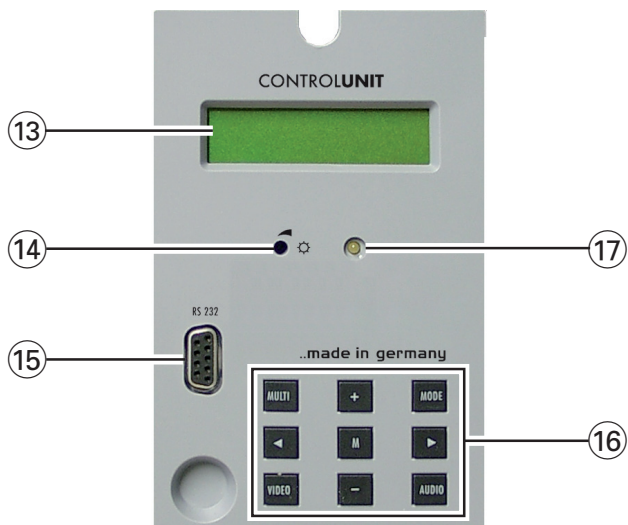

8 THE CONTROL PANEL AT A GLANCE

8.1 CONTROL PANEL

Program the head-end station using the buttons (control panel) on the control unit.

MODE	scrolls forward through the menus.
AUDIO	scrolls backward through the menus.
< / >	select parameters/submenus.
+ / -	set values and trigger actions.
MULTI	selects presets.
M	saves all entries.



8.2 MENU ITEMS

The key pad on the head-end station is used to scroll through the menus. The two-line display of the control unit then shows the menus. The parameters and functions to be set are underlined.

Use the **MODE** key to select the following main menu items:

- System information
- Output level of the cassettes
- Output level of the head-end station
- Number of the head-end station
- Modem
- Password

9 UPDATING THE SOFTWARE OF THE CONTROL UNIT

9.1 UPDATING SOFTWARE VIA PC

The RS 232 interface of the control unit enables you to use a PC or a notebook and the "**BE-Flash**" software to update the operating software of the control unit.

You can find the "**BE-Flash**" software and the current operating software of the head-end station's control unit at the website "www.gss.de/en".

- Use a "one-to-one cable" to connect the control unit's RS 232 interface and the PC.



—> For PCs with USB connector (without serial interface), we recommend the DeLOCK "USB 2.0 to Serial adapter" (Product No. 61460).

- Start the "**BE-Flash**" software and update the software of the control unit.

9.2 UPDATING THE SOFTWARE VIA SECOND CONTROL UNIT

In this type of update, the current version of the software in one control unit (master) is transferred to the control unit you want to update (slave).

REMOVING MASTER CONTROL UNIT

- Switch off the head-end station.
- Disconnect snap-in hook (23) in the direction of arrow "1".
- Pull control unit (7) in the direction of arrow "2" on the bottom and disconnect from snap-in hook (24).

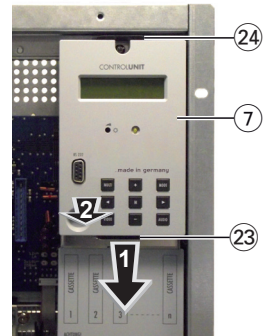

PROGRAMMING SLAVE CONTROL UNIT

- Switch off the head-end station of the slave control unit.
- Connect the 15-pin D-SUB plug on the back of the master control unit to the RS 232 interface of the head-end station's slave control unit via a connection cable made on-site as follows.

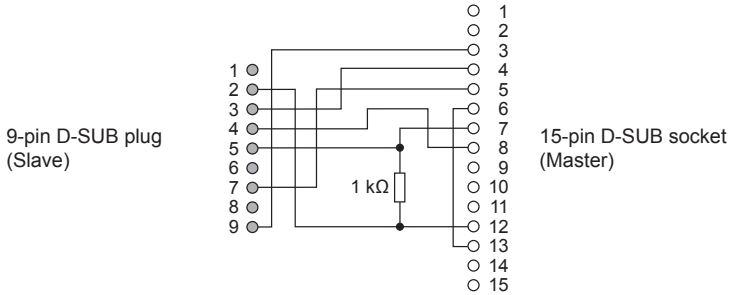

- Switch on the head-end station.
- Wait for the "**Update Mode**" message of the master control unit and press button **M** on this unit.

—> The software of the slave control unit is replaced by the master control unit's software.

- After the message "**Update Mode OK**" appears, switch off the head-end station.
- Remove the connection cable between the slave and master control units.
- Switch on the head-end station.

—> The head-end station's slave control unit registers with the current version of the software.

INSERTING MASTER CONTROL UNIT

- Connect control unit (7) to the snap-in hook (24).
- Push the control unit towards the head-end station, in the direction opposite that of arrow " 2 " on the bottom, and connect it to the 15-pin D-SUB socket of the head-end station.
- Connect snap-in hook (23) in the direction opposite that of arrow " 1 ".

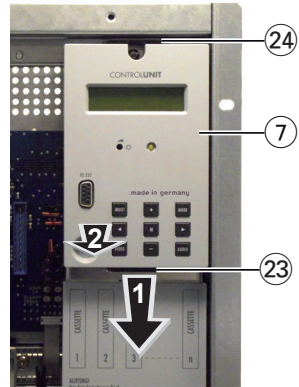

11 PROGRAMMING

11.1 PREPARATION

- Connect the test receiver to the test output of the head-end station.
- Set the RF output data of the cassettes used.

—> In the following software version 45 is described. The latest version of this assembling instructions can be found in the internet at "www.gss.de/en"

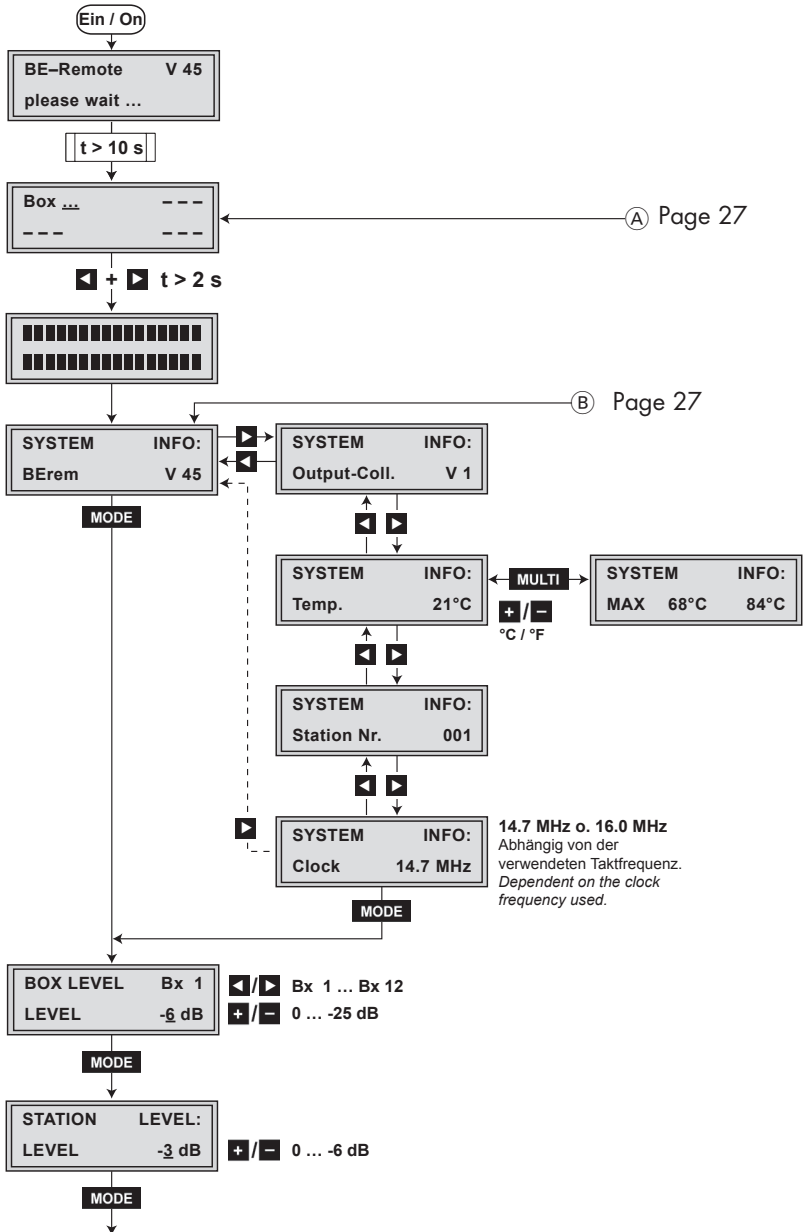

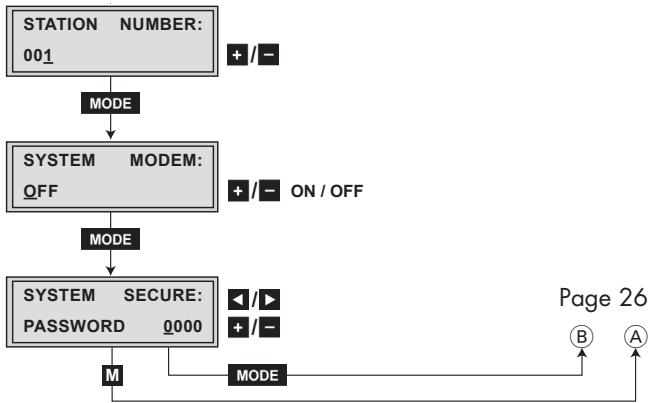

MESSAGE AFTER TEMPERATURE EXCEEDING

Instead of the standby "BE-Remote" menu the "ATTENTION" menu is displayed.

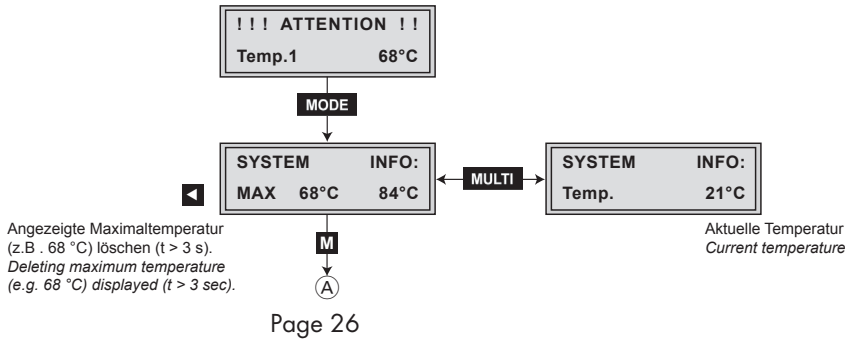

- > Pressing the **MODE** button for longer than 2 seconds cancels the programming procedure. This takes you back to the program item "Activating system information" from any menu. Any entries that have not been saved are reset to the previous settings.
- > Entries in the menus can be saved by pressing the **M** key. You are taken back to the "Activating system information" menu item.

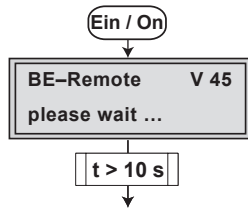

- Switch on the head-end station.

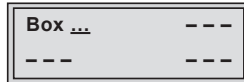

- > The display shows the software version of the head-end station (e.g. "V 45").
- > The processor reads the cassettes' data (approx. 10 seconds).

ACTIVATING SYSTEM INFORMATION



- Activate the "System information" software by simultaneously holding down the buttons  and  for more than 2 seconds in the "Selecting the cassette" mode.

—> The display darkens.

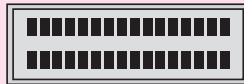

Afterwards the "System information – control unit" –
"SYSTEM INFO: **BE Remote**" menu appears.

—> The "System information" software also can be called up from the stand-by mode of the display.

SYSTEM INFORMATION – CONTROL UNIT

This menu shows the software version of the control unit (e.g. "V 45").



SYSTEM	INFO:
BErem	V 45

PERFORM SETTINGS

- Press the **MODE** button.

—> The "Setting the RF output level of the cassettes –
"BOX LEVEL" is activated.
Continue on page 30.

CALL UP INFORMATION ABOUT THE HEAD-END STATION

- Press the  button (following information menus) or the  button (previous information menus).

—> The "System information – output collector" –
"SYSTEM INFO: **Output Coll.**" submenu is activated.

SYSTEM INFORMATION – OUTPUT COLLECTOR

This menu shows the software version of the output collector (e.g. "V 1").

SYSTEM	INFO:
Output-Coll.	V 1

- Press the **▶** button.

—> The "System information – temperature" –
"SYSTEM INFO: Temp." submenu is activated.

SYSTEM INFORMATION – TEMPERATURE

This menu shows the temperature inside the head-end station. Additionally the temperature display can be switched from degree Celsius to degree Fahrenheit and the highest inner temperatures recorded to date can be displayed.



- Using the **+** / **-** buttons set the temperature display wished.
- To activate the highest inner temperatures press the **MULTI** button.

—> Press the **MULTI** button again to return to the previous menu.

- Press the **▶** button.

—> The "System information – number of the head-end station" –
"SYSTEM INFO: Station Nr." submenu is activated.

SYSTEM INFORMATION – NUMBER OF THE HEAD-END STATION

This menu shows the number of the head-end station (see also item "Setting the consecutive number of the head-end station", page 31).

SYSTEM	INFO:
Station Nr.	001

- Press the **▶** button.

—> The "System information – clock frequency" –
"SYSTEM INFO: **Clock**" submenu is activated.

SYSTEM INFORMATION – CLOCK FREQUENCY

This menu shows the clock frequency of the control unit. The frequency can be 14.7 or 16.0 MHz.

SYSTEM	INFO:
Clock	14.7 MHz

- Press the **MODE** button.

—> The "Setting the RF output level of the cassettes" –
"BOX LEVEL" menu is activated.
—> Pressing the **▶** button you return to the
"System information – control unit" –
"SYSTEM INFO: **BE-Remote**" menu (page 28).

SETTING THE RF OUTPUT LEVEL OF THE CASSETTES

This menu allows to select the cassettes one after the other and set their RF output levels.

BOX LEVEL	Bx 1
LEVEL	-6 dB

- Select all cassettes one after the other using the **◀/▶** buttons, measure and note their RF output levels.
- Activate the cassettes with higher RF output levels using the **◀/▶** buttons

and equal their RF output levels to the value of the cassette with the lowest RF output level using the **+**/**-** buttons ("0 ... -25 dB")

- Press the **MODE** button.

→ The "Setting the RF output level of the head-end station" – "STATION LEVEL:" menu is activated.

SETTING THE RF OUTPUT LEVEL OF THE HEAD-END STATION

This menu allows to set the RF output level of the head-end station to the requirements of the cable system.

STATION	LEVEL:
LEVEL	-3 dB

- Set the RF output level of the head-end station using the **+**/**-** buttons ("0 ... -6 dB").
- Press the **MODE** button.

→ The "Setting the consecutive number of the head-end station" – "STATION NUMBER:" menu is activated.

SETTING THE CONSECUTIVE NUMBER OF THE HEAD-END STATION

If several head-end stations are used in a cable system the head-end stations must get a consecutive number to identify them if the PSW 1000 software is used.

STATION NUMBER:
001

- Use the **+**/**-** buttons to set the consecutive number.
- Press the **MODE** button.

→ The "Activating the modem connection" – "SYSTEM MODEM:" menu is activated.

ACTIVATING THE MODEM CONNECTION

If the head-end station is to be remote controlled using the PSW 1000 configuration software and a modem connected to the head-end station (without HRCU 8 / RCU 1) activate the modem mode in this menu ("ON").

SYSTEM	MODEM:
OFF	

- Using the **+**/**-** buttons switch on the modem mode "ON" or if necessary switch it "OFF".

—> If no modem is found "NOT FOUND" is displayed.

- Press the **MODE** button.

—> The "Setting the password" – "SYSTEM SECURE:" menu is activated.

SETTING THE PASSWORD

In this menu the access to the software of the control unit and the cassettes can be refused.

SYSTEM	SECURE:
PASSWORD	0000

- Use the **◀**/**▶** buttons to place the cursor under the digits to be set for the password.
- Use the **+**/**-** buttons to set the digits of the password wished.

SAVING SETTINGS

- Press the **M** button.

- The settings are saved.
- You return to the "Activating system information" menu item (page 28).
- By pressing the **MODE** button, you will be returned to the menu item "System information – control unit" **without** saving the programmed data (page 28).

PROGRAMMING THE HEAD-END STATION (FOLLOWING EXCESS TEMPERATURE)

If the maximum permissible temperature for the head-end station (inner temperature) is exceeded, "**ATTENTION**" appears in the display instead of the "**BE-Remote**" standby display.

In this operating state, the menus for the cassettes and operating unit are locked. To be able to access the menus for the cassettes and operating unit, the software needs to be unlocked.



The cause of the excess temperature must be determined and the appropriate corrective measures taken for the head-end station to operate smoothly again (e.g. additional ventilation, air conditioning).

In the "**ATTENTION**" menu, the number of the particular head-end station (e.g. "**Temp.1**") and the temperature (e.g. "**68 °C**") are displayed.



- Press the **MODE** button.

- The "System information" – "**SYSTEM INFO:**" menu is activated.

SYSTEM INFORMATION

In this menu, the inner temperature is displayed which activated the lock (e.g. "68 °C") and the highest inner temperature recorded to date (e.g. "84 °C"). The inner temperature which activated the lock must be deleted to reactivate the temperature monitor and the software. You can also select the current inner temperature.



- Press the **MULTI** button to select the current inner temperature (e.g. "21 °C").

—> Press the **MULTI** button again to return to the previous menu.

- Press and hold down the **◀** button for at least 3 seconds to delete the activation temperature (e.g. "68 °C").

—> The current inner temperature appears.

- Press the **M** button.

—> The settings are saved.

—> You return to the "Activating system information" menu item (page 28).

—> For basic operations of the software please note the operating instructions PSW 1000.



REDUNDANT POWER SUPPLY

Via a corresponding management system and the software PSW 1000, it is possible to check the condition of the power supplies and if necessary to switch off and on all cassettes of the station (reset).

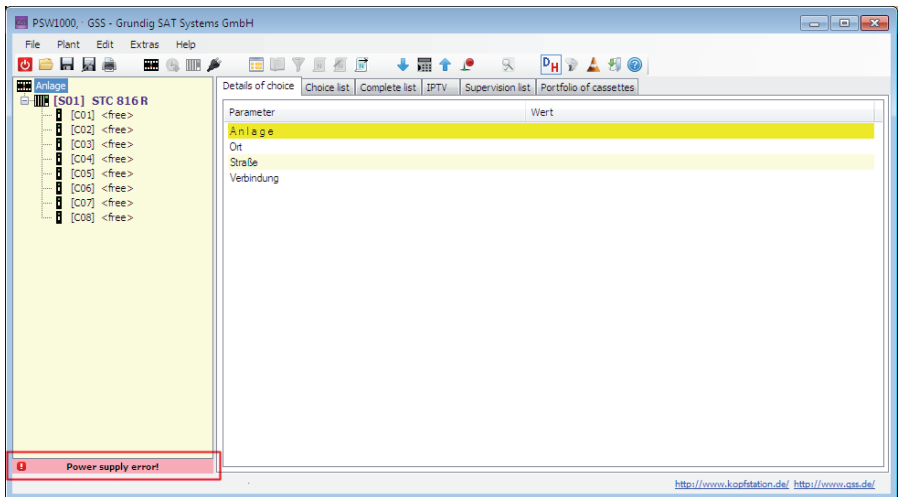
- Establish a connection to the head-end station via the PSW 1000 and read in the data.



—> If a power supply error is present, the following message blinks in the lower left section of the main window.

 **Power supply error!**
 **Power supply error!**

- Open window "Redundant Power Supply" by clicking on button  or via menu **Edit > Redundant Power Supply**.

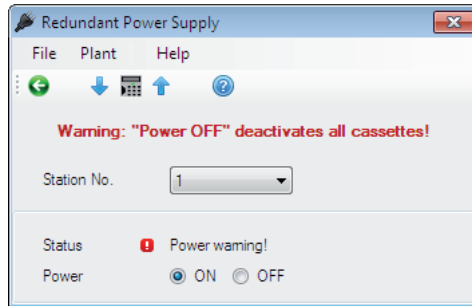

- Select via pull down menu "Station No." the corresponding head-end station if several STC 816 R are connected to the management system. Status information are displayed in the lower section of the window.

- If "OK" is displayed, both power supplies work well.
- If "Power warning!" is displayed, one power supply is defective/switched off, nevertheless the operating voltage is present via the second power supply.
- If "Power ERROR!" is displayed, both power supplies are defective/switched off, the station is out of order.

RESTART THE CASSETTES OF A STATION (RESET)

Via **Power** ON OFF the supply voltages of the cassettes can be switched OFF and ON again. The power supply of the control unit is retained.

- Activate check box "OFF" and transmit the command to the station using button .

→ The supply voltages of the cassettes is switched off.

- Activate check box "ON" and transmit the command to the station using button .



→ The supply voltages of the cassettes is switched on.

The output level of stations and cassettes equipped with an electronic level controller can be set via this menu. The stored maximum temperature can be reset.

- If button  becomes "active" after selecting a station in the left window (tree structure) of the PSW 1000 the station is equipped with an electronic level controller. Access for this menu is only possible via this button.
- The setting of the output level of cassettes is possible from the control units software version V44 (BE-Remote) on.

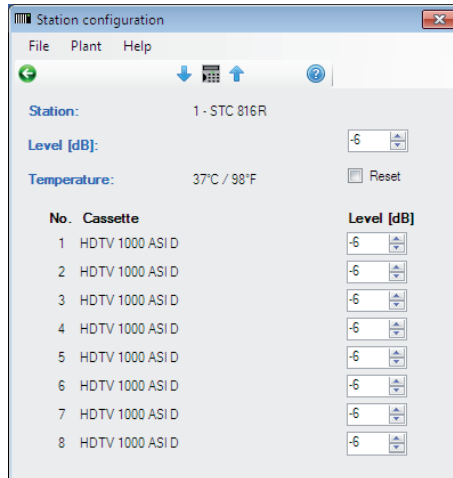
- Click to button  an.



- Adjust the output level of the station via buttons  to the desired value (0...-6dB).
- Adjust the output level of the corresponding cassette via the corresponding buttons  to the desired value (-25...0dB).
- Activate the check box "Reset" in order to reset the stored temperature.
- Send the setting to the station .

- Using button  the current values of the plant can be read out again.



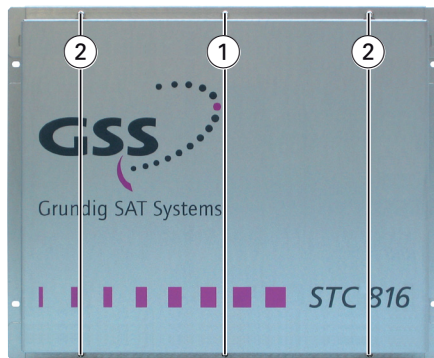

After installing the head-end station, upgrading accessories or installing cassettes it is necessary to tighten all cable connections, cable terminals and cover screws in order to maintain compliance with current EMC regulations securely.

- Securely tighten the cable connections (Cinch, RF connectors) using an appropriate open-ended spanner.
- Hang the front cover into the mounting screws (2).
- Tighten the mounting screws.
- Attach the locking screws (1) and tighten it



To avoid disturbances and problems in reception in the connected cable network, it is absolutely necessary to adjust the output level of the complete receiving installation to the necessary linear values (for example FM, 64 QAM 8-16dB and 256 QAM 4-6dB below the analogous level)!

Declaration of CE conformity

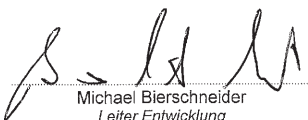
	Konformitätserklärung Declaration of Conformity 008/ 14		
Der Hersteller/Importeur The manufacturer/importer	GSS Grundig SAT Systems GmbH		
Anschrift / Address / Adresse	Beuthener Straße 43, D-90471 Nürnberg, Germany		
erklärt hiermit eigenverantwortlich, daß das Produkt: declare under their sole responsibility that the product:			
Bezeichnung / Name / Description	Kopfstation		
Type / Model / Type	STC 816 R		
Bestell-Nr. / Order-No.	GAS 6000		
folgenden Normen entspricht: is in accordance with the following specifications:			
<i>EN 50083-2:</i>	<i>2012</i>	<i>EN 60950-1:</i>	<i>2006</i>
<i>EN 61000-3-2:</i>	<i>2006</i>	<i>EN 60950-1+ A11:</i>	<i>2009</i>
<i>EN 61000-3-2 + A1:</i>	<i>2009</i>	<i>EN 60950-1+ A1:</i>	<i>2010</i>
<i>EN 61000-3-2 + A2:</i>	<i>2009</i>	<i>EN 60950-1+A12</i>	<i>2011</i>
<i>EN 61000-3-3:</i>	<i>2008</i>	<i>EN 55022 :</i>	<i>2010</i>
<i>EN 50581 :</i>	<i>2012</i>	<i>EN 55024 :</i>	<i>2010</i>
Das Produkt erfüllt somit die Forderungen folgender EG-Richtlinien: Therefore the product fulfils the demands of the following EC-Directives:			
2006/95/EG	Richtlinie betreffend elektrische Betriebsmittel zur Verwendung innerhalb bestimmter Spannungsgrenzen Directive relating to electrical equipment designed for use within certain voltage limits		
2004/108/EG	Richtlinie über die elektromagnetische Verträglichkeit Directive relating to electromagnetic compatibility		
2011/65/EG	Richtlinie zur Beschränkung der Verwendung bestimmter gefährlicher Stoffe in Elektro- und Elektronik Altgeräten Directive on the restriction of the use of certain hazardous substances in electrical and electronic equipment		
Nürnberg, 28. April 2014			
 Michael Bierschneider Leiter Entwicklung Manager Development / Directeur Développement			

Service:

Phone: +49 (0) 911 / 703 2221
Fax: +49 (0) 911 / 703 2326
Email: service@gss.de