

# 2012

CATALOGUE 126

# PA TECHNOLOGY

Technology for an  
Excellent Sound



  
**MONACOR®**

## PRODUCTS

100 V Zone Mixing Amplifier	E 2 – E 7, E 29	Active Lecterns	E 70 – E 74
Desktop Microphones	E 2, E 9, E 46	Control Unit	E 75
Insertions for Amplifiers	E 8	Microphone Stations	E 75
100 V Power Amplifiers	E 12 – E 14, E 27, E 28	Audio Transmission System and Accessories	E 76 – E 79
Evacuation Controller	E 16	100 V A/B Speakers	E 82, E 83
Line Monitoring	E 16	100 V Ceiling Speakers	E 84 – E 93, E 100
Charging Controller	E 18	Low-impedance Ceiling Speakers	E 94 – E 98
Rechargeable Battery	E 18	Underwater Speakers	E 99
Emergency Power Supply	E 19	100 V Flush-mount Speakers	E 101
CD and MP3 CD Players	E 19, E 36 – E 38	100 V Wall Speakers	E 102, E 103
Feedback Controller	E 20	Wall Speakers	E 104, E 105
Emergency Sound System	E 20	100 V Ball Speakers	E 106
Monitor Unit	E 21	100 V Speakers	E 107 – E 110
Matrix Router	E 21	100 V Speaker Systems	E 111 – E 114, E 131
Line Splitter	E 21	Active Speaker Systems	E 115 – E 117
Ambient Noise Controller	E 22	Low-impedance Speaker Systems	E 118 – E 121
Volume Controls	E 22	100 V Column Speakers	E 122 – E 125
100 V Mixing Amplifiers	E 24 – E 26, E 30 – E 32	Weatherproof Speaker Systems	E 127 – E 129
Portable Mixing Amplifiers	E 33	Speaker Systems	E 130
Microphone Amplifier	E 33	Garden Speakers	E 132
Zone Mixers	E 34, E 35	Music Horns	E 135
Preamplifier	E 35	100 V Horn Speakers	E 136 – E 138
MP3 Recorders	E 37, E 39, E 40	Low-impedance Horn Speakers	E 139 – E 141
CD Changer	E 38	Horn Drivers and Trumpets	E 142
Stereo Receiver	E 39	Audio Exciters	E 143
Stereo Tuner	E 39	Megaphones	E 144 – E 147
SD Memory Cards	E 40	Voice Amplifiers	E 148, E 149
Intercom System	E 43	Volume Controls	E 152, E 154, E 155
Flush-mount Amplifiers	E 43	Programme Selectors	E 154, E 155
Loop Amplifier	E 44, E 45	Surface-mount Housings	E 156
Inductive Receiver	E 44	100 V Transformers	E 158
Boundary Microphones	E 47	Switch Boxes	E 160
Build-in Microphones	E 47	Audio Converter	E 160
Microphones	E 48	Universal Supports	E 161
Gooseneck Microphones	E 48, E 49	Cables	E 162
Tie Clip and Headband Microphones	E 50	Cables and Accessories	E 163
Floor Stands	E 51	Racks	E 164, E 165
Accessories	E 51, E 55, E 69, E 126, E 156	Rack Panels	E 166, E 167
Wireless Microphone Systems	E 52 – E 54	Mounting Plates	E 168
Unit Holder	E 55	Power Strips	E 169
Portable Amplifier Systems	E 56 – E 58, E 60 – E 67	Index	E 171, E 172
Accessories for Portable Systems	E 57, E 59, E 67	Important Information	E 173
Additional Speaker System	E 63		
Portable Infrared Amplifier System	E 68		
Infrared Amplifier	E 69		

## KNOW-HOW

100 V PA Technology	E 10, E 11	Arrangement of Ceiling Speakers	E 133
Voice Alarm Systems	E 15	Example of Application: PA Application for Sports Fields (high-quality)	E 134
Example of Application: MEVAC System (Evacuation System)	E 17	100 V Volume Control	E 150, E 151
Remote Volume Control	E 23	Programme Selectors	E 153
Example of Application: Multizone PA Application	E 41	Chassis Jacks for ATT-500U	E 157
Examples of Application: PATL-100	E 42	100 V Transformation	E 159
Example of Application: PA System for Conference Rooms	E 80	Speaker Cables	E 170
Flush-mount Ceiling Speakers	E 81		

Technology for an Excellent Sound





## PA-40120

Order No. 17.3220



**4-zone PA amplifier**, with 4 active 120W outputs, for setting up a multi-zone PA system. A switch allows each of the 5 inputs to be assigned to one of the 4 outputs. Thus, it is possible to reproduce varying programmes in different areas. Another advantage is that an announcement in one area will not interrupt the programme in another area. With the optional zone-paging microphone PA-4000RC, the amplifier can be extended to a 4-channel PA system. In combination with the fireman's microphone PA-4000FMP with integrated voice memory, e.g. an acoustic alarm system can be set up in schools.

- 4 x 120W<sub>RMS</sub>
- 4 zones, can be controlled individually
- 3 mic/line inputs and 2 line inputs
- Built-in adjustable monitor speaker
- Chime and siren can also be activated via external momentary push-button
- Bass, treble and master controls, level display via LEDs, regulated fan
- Phantom power for electret microphones
- Connection for microphone PA-4000PTT
- Connections for 4 PA fireman's microphones PA-4000FMP
- Mains operation and 24V emergency power operation

Model	PA-40120
<b>General information</b>	
Output power	4 x 120W <sub>RMS</sub> , 4 x 170W <sub>MAX</sub>
Inputs	
Mic/line 1-3	2.5mV/5kΩ, 0.3V/15kΩ
Line 4-5	0.3V/15kΩ
Outputs	
Speakers	4 x 4Ω, 4 x 70V/100V
Preamplifier	0.775V/200Ω
Record	0.775V/3kΩ
Frequency range	45-20,000Hz
Tone control	
Bass	±10dB/100Hz
Treble	±10dB/10kHz
S/N ratio	
Mic	> 70dB, A-weighted
Line	> 90dB, A-weighted
THD	< 1%
Admiss. ambient temp.	0-40 °C
Power supply	230V~/50Hz/1,500VA, 24V~/40A
Dimensions	482x90x377mm, 2RS
Weight	22.1kg
<b>Inputs</b>	
Mic/line	3 x 6.3mm/XLR (combo)
Line	2 x RCA L/R
Push-to-talk microphone	1 x RJ-45
Emergency	4 x RJ-45
<b>Outputs</b>	
Chime mom. push-button	screw terminals
Preamplifier	4 x screw terminal
Speakers	4 x screw terminal
Monitor	1 x 6.3mm jack
Record	1 x RCA L/R
<b>Power supply</b>	
230V~	mains cable
24V=	screw terminals

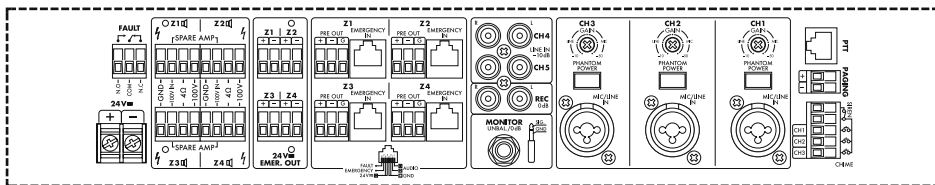

## PA-4000PTT

Order No. 23.6000

**PA desktop microphone (push-to-talk)**, for the connection to PA-40120 or PA-1120, PA-1240, PA-1410MX, PA-1412MX and the PA-6000 series.

- Automatic chime via microphone announcement button (talk)
- Chime can additionally be switched on or off
- Power supply via connected amplifier
- RJ-45 jack for the connection to PA-40120
- Supplied with 3m connection cable (Cat. 5e)
- 7-pole DIN jack for the connection to PA-1120, PA-1240, PA-1410MX and the PA-6000 series, supplied with 2m connection cable

**Only one PA-4000PTT can be connected to each amplifier!**



## PA-4000RC

Order No. 23.6010

**PA zone paging desktop microphone**, for the connection to PA-40120.

- Selector buttons for 4 zones, for activating one or several zones
- ALL CALL button for activating each of the 4 zones
- Automatic chime via microphone announcement button (talk)
- LED status indication for the zone buttons (busy, emergency), power, mic fault, signal and talk
- Built-in gooseneck electret microphone
- Adjustable microphone sensitivity
- Chime can additionally be switched on or off
- 24V power supply via PA-40120
- Two RJ-45 jacks for the connection to PA-40120 and additional PA-4000RC
- Supplied with connection module for PA-40120
- Up to 32 PA-4000RC can be connected to PA-40120 via bus
- Supplied with 3m connection cable (Cat. 5e)



## PA-4000FMP

Order No. 17.3230

PA fireman's microphone, for PA-40120, wall mounting.

- Hand-held microphone with operational monitoring
- Alarm input for triggering alarm
- Integrated digital voice storage (60 seconds max.) with microphone input or line input (1 x RCA L/R) for recording messages

- Recorded message is also kept without operating voltage
- Siren emits an acoustic signal for 10 seconds when alarm is triggered, adjustable volume
- RJ-45 jack for the connection to 4-zone PA amplifier PA-40120
- Signal red lacquered metal housing

Model	PA-4000FMP
Output level	0.775V/600Ω, bal.
Siren frequency	800Hz (continuous sound) 550/1,200Hz (wailing sound)
Max. recording time	60 seconds
Power supply	24V <sub>DC</sub> via PA-40120 or optional PSU
Dimensions	250x300x77mm
Weight	3.2kg

## PA-12040

Order No. 17.3390

## PA-4040

Order No. 17.2520



4-zone mono mixing amplifiers, with professional features for universal multi-room PA applications.

- 4 x 120W<sub>RMS</sub> (PA-12040)
- 4x40W<sub>RMS</sub> (PA-4040)
- 100V and 4Ω/8Ω operation
- Perfect utilisation of the capacity and reliable protection of the connected speakers due to an integrated limiter
- 4 inputs microphone/line via comb. jacks
- 1 input line stereo via RCA jacks
- Each input channel with gain control, 2-way tone control, channel mute switch and routing switch for zones
- Microphone inputs with phantom power, can be switched on additionally as required
- Priority function for channels 1-3, switchable
- Independent paging input, can be routed to all zones
- 4 zone outputs, can be controlled individually
- Zone and monitor line outputs for additional amplifiers or recorders
- Connection for monitor speakers
- Level control via VU meters for zone and monitor
- Adjustable headphone output
- Fan-cooling
- 230V mains operation

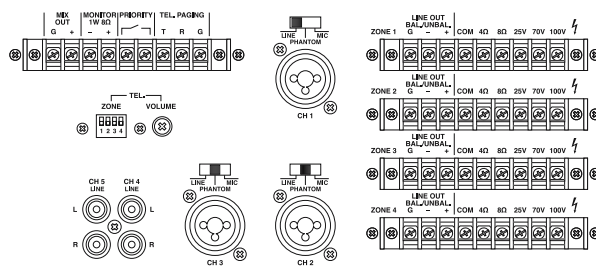

Model	PA-12040	PA-4040
<b>General information</b>		
Output power	4 x 120W <sub>RMS</sub> 4 x 170W <sub>MAX</sub>	4 x 40W <sub>RMS</sub> 4 x 65W <sub>MAX</sub>
Inputs		
Mic/line	5mV/4kΩ, 100mV/10kΩ	5mV/4kΩ, 100mV/10kΩ
Line	100mV/30kΩ	100mV/30kΩ
Telephone paging	40mV/5kΩ	40mV/5kΩ
Outputs		
Speakers	4 x 25V/70V/100V, 4Ω/8Ω	4 x 25V/70V/100V, 4Ω/8Ω
Monitor speakers	8Ω/1W	8Ω/1W
Line (zone)	1.7V, bal.	1.7V, bal.
Line (mix out)	3.95V	3.95V
Frequency range	50-17,000Hz	50-17,000Hz
Tone control		
Bass	±10dB/100Hz	±10dB/100Hz
Treble	±10dB/10kHz	±10dB/10kHz
S/N ratio, mic	> 65dB	> 65dB
S/N ratio, line	> 75dB	> 75dB
THD	< 1%	< 1%
Admiss. ambient temp.	0-40 °C	0-40 °C
Power supply	230V~/50Hz/1,200VA	230V~/50Hz/450VA
Dimensions	482x133x410mm, 3RS	482x133x310mm, 3RS
Weight	20.5kg	15kg



**PA-6240**

Order No. 17.2180

**PA-6480**

Order No. 17.2190

**PA-6600**

Order No. 17.2390



**6-zone mono PA mixing amplifiers**

- 1 x 240W<sub>RMS</sub> (PA-6240)
- 1 x 480W<sub>RMS</sub> (PA-6480)
- 1 x 600W<sub>RMS</sub> (PA-6600)
- 6 zones, can be controlled individually
- Chime, continuous sound and wailing sound, automatic mute, 2-tone chime or 4-tone chime (selectable)
- Bass, treble and master controls, level display via LEDs, regulated fan
- Insertions for various functions are available at option
- 17V phantom power for electret microphones
- Connection for zone paging microphone PA-6000RC
- 1 insertion compartment at the front for automatic alarm message insertion PA-1120DM, a tuner insertion or a CD player insertion (all available at option)
- 3 insertion facilities at the rear side for optional modules with the following features:
  - PA-6FD: fault detection
  - PA-6FM: fault monitoring
  - PA-6FR: anti-feedback
- Mains operation and 24V emergency power operation
- Removable mounting brackets

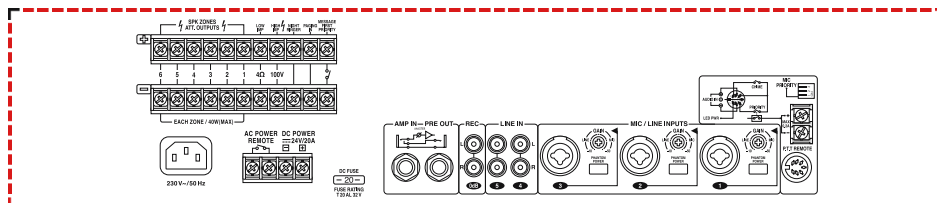

Model	PA-6240	PA-6480	PA-6600
<b>General information</b>			
Output power	240W <sub>RMS</sub> 340W <sub>MAX</sub>	480W <sub>RMS</sub> 680W <sub>MAX</sub>	600W <sub>RMS</sub> 850W <sub>MAX</sub>
<b>Inputs</b>			
Mic/line 1-3	2.5mV/5kΩ, 0.3V/5kΩ	2.5mV/5kΩ, 0.3V/5kΩ	2.5mV/5kΩ, 0.3V/5kΩ
Line 4-5	0.3V/15kΩ	0.3V/15kΩ	0.3V/15kΩ
Preamplifier	0.775V/10kΩ	0.775V/10kΩ	0.775V/10kΩ
<b>Outputs</b>			
Speakers	100V/70V	100V/70V	100V/70V
Preamplifier	0.775V/100Ω	0.775V/100Ω	0.775V/100Ω
Record	0.775V/3kΩ	0.775V/3kΩ	0.775V/3kΩ
Frequency range	55-16,000Hz	55-16,000Hz	55-16,000Hz
<b>Tone control</b>			
Bass	±10dB/100Hz	±10dB/100Hz	±10dB/100Hz
Treble	±10dB/10kHz	±10dB/10kHz	±10dB/10kHz
<b>S/N ratio</b>			
Mic	> 70dB, A-weighted	> 70dB, A-weighted	> 70dB, A-weighted
Line	> 80dB, A-weighted	> 80dB, A-weighted	> 80dB, A-weighted
<b>THD</b>			
	< 1%	< 1%	< 1%
<b>Admiss. ambient temp.</b>			
	0-40 °C	0-40 °C	0-40 °C
<b>Power supply</b>			
	230V~/50Hz/750VA, 24V~/20A	230V~/50Hz/1,500VA, 24V~/40A	230V~/50Hz/1,700VA, 24V~/50A
<b>Dimensions</b>			
	430x133x352mm, 3RS	430x133x352mm, 3RS	430x133x352mm, 3RS
<b>Weight</b>			
	17kg	19.5kg	20kg
<b>Inputs</b>			
Mic/line	3 x 6.3mm/XLR (Combo)	3 x 6.3mm/XLR (Combo)	3 x 6.3mm/XLR (Combo)
Line	2 x RCA L/R	2 x RCA L/R	2 x RCA L/R
Zone paging microphone	2 x RJ-45, optional	2 x RJ-45, optional	2 x RJ-45, optional
Push-to-talk microphone	1 x 7-pole DIN	1 x 7-pole DIN	1 x 7-pole DIN
Telephone system	screw terminals	screw terminals	screw terminals
Ext. amplifier	1 x 6.3mm jack	1 x 6.3mm jack	1 x 6.3mm jack
<b>Outputs</b>			
Mom. push-button for chime	-	-	-
1 x preamplifier	1 x 6.3mm jack	1 x 6.3mm jack	1 x 6.3mm jack
Speakers	screw terminals	screw terminals	screw terminals
Record	1 x RCA L/R	1 x RCA L/R	1 x RCA L/R
<b>Power supply</b>			
230V~	3-pin IEC jack	3-pin IEC jack	3-pin IEC jack
24V=	screw terminals	screw terminals	screw terminals

**PA-6FD**

Order No. 17.2300



**Fault detection module**, for the PA amplifiers PA-6240, PA-6480, PA-6600, PA-3120 and PA-1960.

In order to monitor the functions of the PA amplifier, the module transmits a 20kHz pilot tone and checks this at the amplifier output. In case of a fault, a floating relay contact will be opened. The sensitivity can be adjusted.

**PA-6FM**

Order No. 17.2310

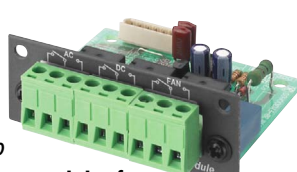

**Fault monitoring module**, for the PA amplifiers PA-6240, PA-6480, PA-6600 and PA-1960.

- Indication of failure of mains voltage and operating voltage
- Indication in case of fan failure
- 3 independent, floating relay outputs (NO/NC)

**PA-6FR**

Order No. 17.2320



**Anti-feedback module**, for the PA amplifiers PA-6240, PA-6480 and PA-6600. The module uses the frequency shift technique. The frequency shift of 2-6Hz is almost noiseless and provides the highest possible protection against acoustic feedback. Beside the activation of the anti-feedback function and the frequency selection (2, 4, 5, 6Hz), no further adjustments are necessary. Affects mic 1 only.



## PA-1120

Order No. 17.0780

## PA-1240

Order No. 17.0790



### 5-zone mono PA mixing amplifiers

- 1 x 120W<sub>RMS</sub> (PA-1120)
- 1 x 240W<sub>RMS</sub> (PA-1240)
- 5 zones, can be controlled individually
- Chime, continuous sound and wailing sound, automatic mute, 2-tone chime or 4-tone chime (selectable)
- Bass, treble and master controls, level display via LEDs, regulated fan
- Insertions for various functions are available at option
- 17V phantom power for electret microphones
- Connection for microphones PA-1120RC and 1 x PA-1120PTT
- Automatic alarm announcement with insertion PA-1120DM (available at option)
- Mains operation and 24V emergency power operation
- Removable mounting brackets

Model	PA-1120	PA-1240
<b>General information</b>		
Output power	120W <sub>RMS</sub> 170W <sub>MAX</sub>	240W <sub>RMS</sub> 340W <sub>MAX</sub>
<b>Inputs</b>		
Mic/line 1-3	2.5mV/5kΩ, 0.3V/5kΩ	2.5mV/5kΩ, 0.3V/5kΩ
Line 4-5	0.3V/15kΩ	0.3V/15kΩ
Preamplifier	0.775V/10kΩ	0.775V/10kΩ
<b>Outputs</b>		
Speakers	100V/70V	100V/70V
Preamplifier	0.775V/100Ω	0.775V/100Ω
Record	0.775V/3kΩ	0.775V/3kΩ
Frequency range	55-16,000Hz	55-16,000Hz
<b>Tone control</b>		
Bass	±10dB/100Hz	±10dB/100Hz
Treble	±10dB/10k Hz	±10dB/10k Hz
<b>S/N ratio</b>		
Mic	> 70dB, A-weighted	> 70dB, A-weighted
Line	> 80dB, A-weighted	> 80dB, A-weighted
THD	< 1%	< 1%
Admiss. ambient temp.	0-40 °C	0-40 °C
<b>Power supply</b>	230V~/50Hz/340VA, 24V~/15A	230V~/50Hz/630VA, 24V~/12A
<b>Dimensions</b>	482x133x352mm, 3RS	482x133x352mm, 3RS
<b>Weight</b>	13kg	14kg
<b>Inputs</b>		
Mic/line	3 x 6.3mm/XLR (combo)	3 x 6.3mm/XLR (combo)
Line	2 x RCA L/R	2 x RCA L/R
Zone paging microphone	2 x RJ45, optional	2 x RJ45, optional
Push-to-talk microphone	1 x 7-pole DIN	1 x 7-pole DIN
Telephone system	screw terminals	screw terminals
Ext. amplifier	1 x 6.3mm jack	1 x 6.3mm jack
<b>Outputs</b>		
Mom. push-button for chime	-	-
1 x preamplifier	1 x 6.3mm jack	1 x 6.3mm jack
Speakers	screw terminals	screw terminals
Record	1 x RCA L/R	1 x RCA L/R
<b>Power supply</b>		
230V~	3-pin IEC jack	3-pin IEC jack
24V=	screw terminals	screw terminals

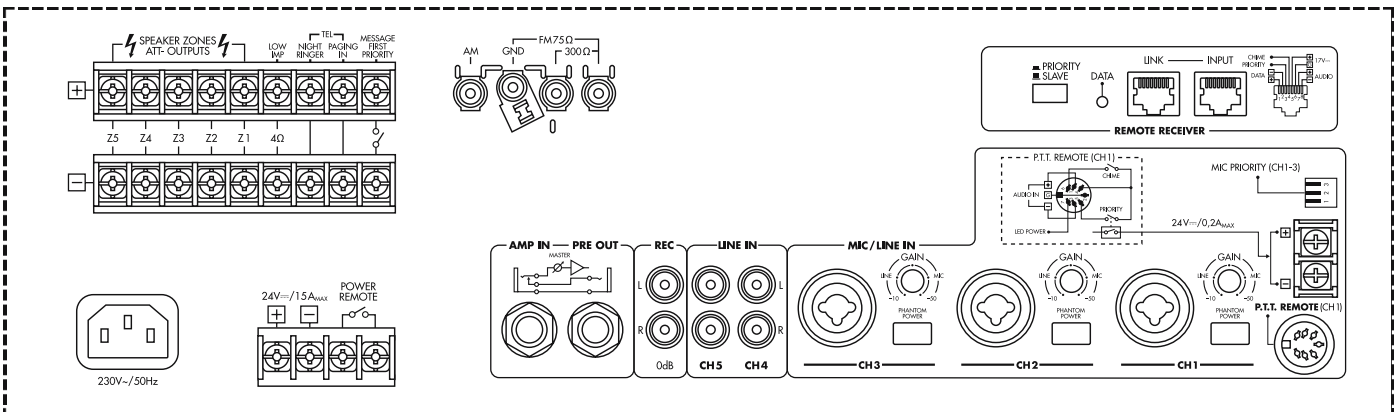



## PA-5240

Order No. 24.3140



## PA-5480

Order No. 24.3150



### 5-zone mono PA mixing amplifiers

- 1 x 240W<sub>RMS</sub> (PA-5240)
- 1 x 480W<sub>RMS</sub> (PA-5480)
- 5 zones, can be controlled individually
- Chime, wailing sound, automatic mute, chime and siren can also be activated via external momentary push-button, 2-tone chime or 4-tone chime (selectable)
- Bass, treble and master controls, level display via LEDs, regulated fan
- Insertions for various functions are available at option
- Phantom power for electret microphones
- Connection for microphone PA-5000PTT
- Alarm announcement with insertion PA-1120DM (available at option)
- Mains operation and 24V emergency power operation
- Removable mounting brackets

Model	PA-5240	PA-5480
<b>General information</b>		
Output power	240W <sub>RMS</sub> 340W <sub>MAX</sub>	480W <sub>RMS</sub> 680W <sub>MAX</sub>
<b>Inputs</b>		
Mic 1	2.5mV/2kΩ	2.5mV/2kΩ
Mic/line 2-4	2.5mV/2kΩ, 0.3V/200kΩ	2.5mV/2kΩ, 0.3V/200kΩ
Line 5-7	0.3V/5kΩ	0.3V/5kΩ
Preamplifier	0.775V/10kΩ	0.775V/10kΩ
<b>Outputs</b>		
Speakers	100V/70V	100V/70V
Preamplifier	0.775V/100Ω	0.775V/100Ω
Frequency range	55-16,000Hz	55-16,000Hz
<b>Tone control</b>		
Bass	±10dB/100Hz	±10dB/100Hz
Treble	±10dB/10kHz	±10dB/10kHz
<b>S/N ratio</b>		
Mic	> 70dB	> 70dB
Line	> 80dB	> 80dB
<b>THD</b>	< 1%	< 1%
<b>Admiss. ambient temp.</b>	0-40 °C	0-40 °C
<b>Power supply</b>	230V~/50Hz/750VA, 24V~/20A	230V~/50Hz/1,500VA, 24V~/40A
<b>Dimensions</b>	482x133x352mm, 3RS	482x133x352mm, 3RS
<b>Weight</b>	16.5kg	20kg
<b>Inputs</b>		
Mic/line	2 x 6.3mm/XLR (combo), 1 x 6.3mm jack	2 x 6.3mm/XLR (combo), 1 x 6.3mm jack
Line	screw terminals, 3 x RCA L/R	screw terminals, 3 x RCA L/R
<b>Zone paging microphone</b>	screw terminal	screw terminal
<b>Push-to-talk microphone</b>	screw terminal	screw terminal
<b>Telephone</b>	-	-
<b>Preamplifier</b>	1 x 6.3mm jack	1 x 6.3mm jack
<b>Outputs</b>		
Mom. push-button for chime	screw terminals	screw terminals
Preamplifier	1 x 6.3mm jack	1 x 6.3mm jack
Speakers	screw terminals	screw terminals
<b>Power supply</b>		
230V~	3-pin IEC jack	3-pin IEC jack
24V=	screw terminals	screw terminals

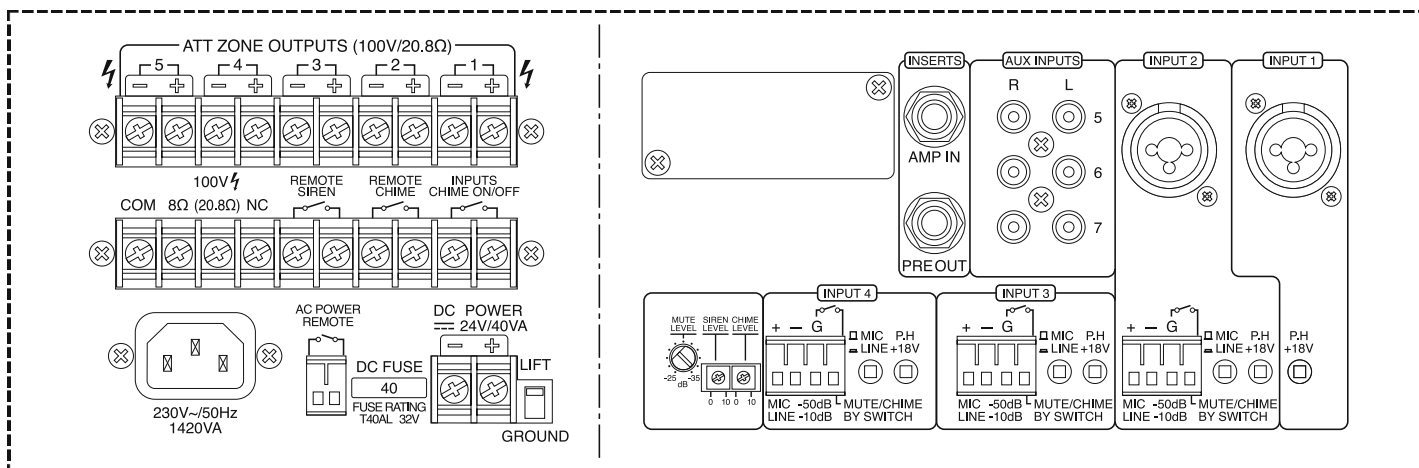



## PA-1200

Order No. 17.0710



### 4-zone mono PA mixing amplifier

- 1 x 120W<sub>RMS</sub>
- Chime, continuous sound and wailing sound, automatic mute, chime can also be activated via external momentary push-button, 2-tone chime or 4-tone chime (selectable)
- Bass, treble and master controls, level display via LEDs
- 15V phantom power for channels 2 and 3
- Insertions for various functions are available at option
- 482mm (19") rack installation with mounting frame PA-1200RM, available at option
- Mains operation and 24V emergency power operation



## PA-1200RM

Order No. 12.6740



**Mounting frame**, for the installation of PA mixing amplifier PA-1200 into a 482mm (19") rack, black lacquered.

Inside dimensions: 420x290mm, 3RS

Model	PA-1200
<b>General information</b>	
Output power	120W <sub>RMS</sub> 170W <sub>MAX</sub>
Inputs	
Mic	1.5mV/600Ω
Line	150mV/47kΩ
Phono	1mV/47kΩ (RIAA)
Outputs	
Speakers	1 x 4Ω, 1 x 8Ω, 4 x 70/100V
Preamplifier	1V/1kΩ
Frequency range	80-15,000Hz
Tone control	
Bass	±10dB/100Hz
Treble	±10dB/10kHz
S/N ratio	
Mic	> 60dB
Line	> 70dB
THD	< 1%
Admiss. ambient temp.	0-40 °C
Power supply	230V~/50Hz/280VA, 24V~/11A
Dimensions	420x122x350mm
Weight	13kg
<b>Inputs</b>	
Mic	1 x 6.3mm jack
Mic/line	3 x XLR, bal.
Line	1 x RCA L + R
Phono/line	1 x RCA L + R
Telephone	1 x twin spring-load. term.
<b>Outputs</b>	
Tuner	1 x twin spring-load. term.
Mom. push-button for chime	1 x twin spring-load. term.
1 x preamplifier	1 x 6.3mm jack
Speakers	7 x screw terminal
<b>Power supply</b>	
230V~	1 x 3-pin IEC jack
24V=	screw terminals

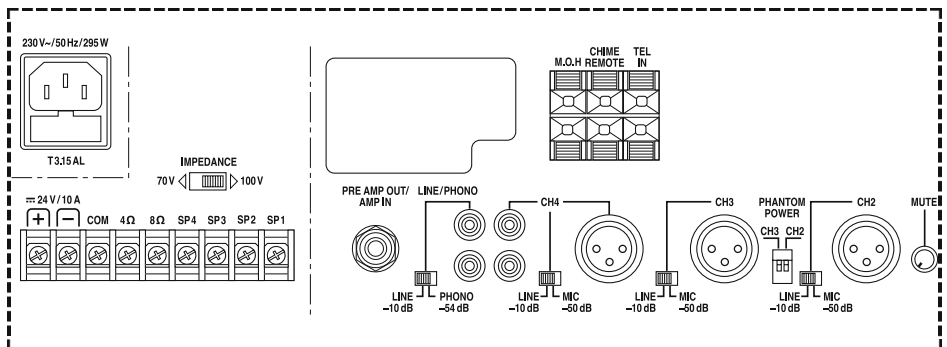





**PA-1200RDS**

Order No. 17.2770

**FM/AM RDS tuner insertion**, for the PA mixing amplifiers with insertion compartment at the front.

- RDS feature for FM
- 24 memory places (18 x FM, 6 x AM)
- Digital display
- Station scanning
- Automatic switching-on after power failure



**PA-1130CD**

Order No. 17.2360



**CD player insertion**, for the PA mixing amplifiers with insertion compartment at the front.

- Anti-shock system
- Slot-in mechanism
- Random play, scan and repeat functions
- Display track/time
- Shock-proof due to oil shock absorber
- Audio CD/CD-R/CD-RW



**PA-1130RCD**

Order No. 17.2200



**RDS tuner/CD player insertion**, for the PA mixing amplifiers with insertion compartment at the front.

FM/AM tuner section:

- RDS function for FM
- 24 memory places (18 x FM, 6 x AM)
- Digital display
- Station scanning

CD player section:

- Anti-shock system
- Slot-in mechanism
- Random play, scan and repeat functions
- Display of track/time
- Shock-proof due to oil shock absorber
- Audio CD/CD-R/CD-RW



**PA-1120DM**

Order No. 17.0830



**Digital message insertion**, for the PA mixing amplifiers with insertion compartment.

- 16Mbits SRAM, 4.5 minutes max. (upgradable to 32Mbits)
- 6 memory places for announcements or similar
- Automatic start of alarm announcement



**PA-1200C**

Order No. 17.1160

**Timer insertion**, with DCF77 radio-controlled clock receiver for the PA mixing amplifiers with insertion compartment.

- 40 memory places, to be programmed and edited as desired
- 3 selectable chimes, remote controllable
- 3 relay contacts (NO/NC) for switching external units
- A combination with digital message insertion PA-1120DM allows time-controlled announcements

**PA-1204EX**

Order No. 24.0250



**4-way module extension**, for all insertion modules of the PA series.

- For accepting up to 4 insertions, 2 max. with CD player mechanism
- Opening for using insertions with radio reception module
- XLR connections
- Mains operation or 24V emergency power operation
- 482mm (19") rack installation with fitted mounting brackets



- Dimensions without brackets (WxHxD): 425x135x380mm, 3RS
- Weight: 7.7kg
- Power supply: 230V~/50Hz/55VA or 24V~/2A

**PA-1200EX**

Order No. 24.8160



**Dual module extension**, for all insertion modules of the PA series.

- For accepting up to 2 insertions
- Opening for using insertions with radio reception module
- XLR connection
- Mains operation or 24V emergency power operation
- 482mm (19") rack installation with fitted mounting brackets



- Dimensions without brackets (WxHxD): 425x88x380mm, 2RS
- Weight: 4.5kg
- Power supply: 230V~/50Hz/55VA or 24V~/2A



## PA-6000RC

Order No. 23.5370

**PA zone paging desktop microphone**, for the connection to PA-6240, PA-6480 and PA-6600.

- Selector buttons for speaker zones 1-6
- Start function/pause function for 6 selectable announcements which are stored in the digital module PA-1120DM
- Automatic chime via microphone announcement button
- Adjustable line input (RCA L/R) for the connection of a signal source, e.g. CD player or tape deck
- LED display for transmission mode
- Power supply via PA-6240, PA-6480, PA-6600
- RJ45 jack for connecting additional PA-6000RC microphones with slave/priority switch
- Supplied with connection module for PA-6240, PA-6480 and PA-6600



## PA-1120RC

Order No. 23.2440

**PA zone paging desktop microphone**, for the connection to PA-1120 and PA-1240.

- Selector buttons for speaker zones 1-5
  - Start function/pause function for 6 selectable announcements which are stored in the digital module PA-1120DM
  - Adjustable line input (RCA L/R) for the connection of a signal source, e.g. CD player or tape deck
  - LED display for transmission mode
  - Automatic chime via microphone announcement button
  - Power supply via PA-1120, PA-1240
  - RJ45 jacks for connecting additional PA-1120RC microphones with slave/priority switch
  - Supplied with connection module for PA-1120 and PA-1240
- Ten PA-1120RC max. can be connected to each amplifier!**



## PA-1120PTT

Order No. 23.2450

**PA desktop microphone (push-to-talk)**, for the connection to PA-1120, PA-1240 and the PA-6000 series.

- Automatic chime via microphone announcement button
- Power supply via respective amplifiers or PA-1410MX (connection via 7-pole DIN, supplied with cable)
- The 24V output for emergency priority circuit is controlled by the amplifiers PA-1120, PA-1240 and the PA-6000 series

**Only one PA-1120PTT can be connected to each amplifier!**



## PAC-1120

Order No. 17.2540

**Connection cable**, for PA desktop microphone PA-1120PTT, for the connection to suitable PA amplifiers and PA preamplifiers.

- Fitted with 2 x 7-pole DIN plug
- Length: 50m



## PA-5000PTT

Order No. 23.3260

**PA desktop microphone (push-to-talk)**, especially suitable for the connection to PA-5240, PA-5480.

- Push-to-talk button with switching contact for activating the chime at the amplifier
- Connection via screw terminal
- Output for priority function

**Three PA-5000PTT can be connected to each amplifier!**

### Introduction to the 100 V PA Technology

The following pages show the planning and setting-up of PA systems for easy rebuilding, give some basic information and useful hints.

The 100 V PA technology includes PA systems for background music, for announcement systems or for PA applications at events. These PA systems have become indispensable.

#### Some of the Applications are:

- Sports fields and gyms
- Department stores
- Workshops and warehouses
- Office buildings
- Churches and chapels
- Restaurants and hotels

#### Basic Characteristic

In a 100 V PA system, the output signal for the speakers following an amplifier is transformed to the higher 100 V value by a transformer. This corresponds to the rated power of the amplifier. This transformer is usually integrated into the amplifier. On the other side, ahead of the speakers, there is also a transformer which transforms this 100 V signal down to the voltage which is suitable for the speaker. This transformer, too, is usually mounted in or at the speaker.

#### Mono Contra Stereo

If 100 V PA systems are regarded in detail, you can notice that most of them are mono systems. Why? To use a stereo signal, 2 speaker systems must not only be driven by 2 power amplifiers but the listener must be at the same distance from both speakers and must stay there. If he leaves this position, there is no stereo perception any more. However, this is always the case e.g. with PA background applications because people move freely through the room. Thus, a genuine mono transmission is the absolutely right choice in this case.

By the way, this mono/stereo consideration is not a question of quality because a mono signal is not inferior to a stereo signal regarding the technical values. The quality is solely determined by the components and especially by the speaker systems used. The sound of a horn speaker is of course not as good as that of a HiFi system. This is, however, due to the speaker type and not due to the 100 V transformer. Nowadays, a modern transformer can achieve a frequency response of 20 to 20,000 Hz.

What is the basic difference between a 100 V PA system and the standard HiFi stereo system?

To simplify the matter, in case of a HiFi system it is tried to arrange a place or a suite and the speakers in the room in such a way, that an optimum sound quality will be obtained. This can also be achieved by rearranging the furniture.

This is not possible, e.g. for background PA applications in a shop. In this case, the furniture cannot be rearranged and the speakers have to be placed where people are gathering. To make this possible, a great number of different speaker types is available, e.g. flush mount speakers, wall speakers, column speakers or horn speakers.

The real advantage of a 100 V PA system can be noticed when wiring the speakers.

With PA systems or systems for PA background applications, the number of speaker systems is sometimes very high.

#### Example:

A furniture shop. Furniture shops have large areas so that there must be an even distribution of sometimes up to 20 speakers or more to be mounted over the area.

In the following text we regard a system with 16 speakers to be connected to an 8 Ω amplifier.

If 8 Ω speakers are used, it must be ensured that the output impedance of the amplifier does not fall below the minimum value. Therefore, it is not possible to connect all 16 speakers in parallel. This would result in a total impedance of 0.5 Ω by which the amplifier would be totally overloaded and destroyed. Thus, the speakers must be wired in series and in parallel so that the impedance of the amplifier does not fall below the minimum value. Our example shows this as follows:

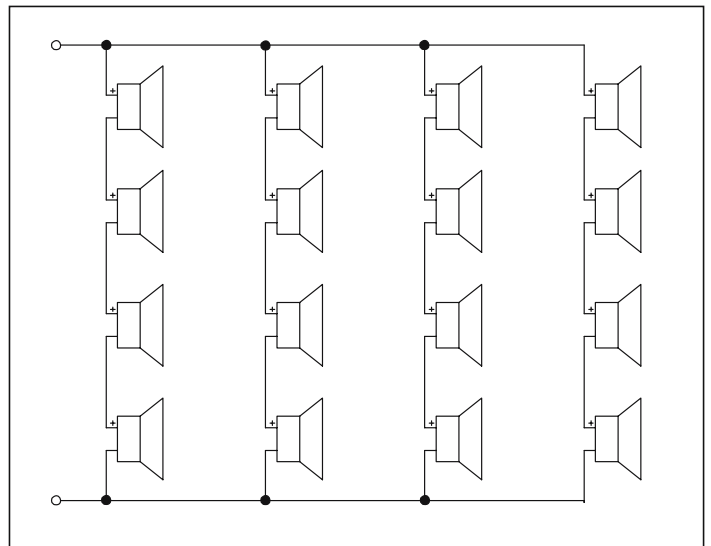

According to the drawing it looks very easy but it means a considerable effort of cabling in a 1,000 m<sup>2</sup> large hall because all speaker cables must be laid to a central point or the wiring has to be made directly at the speaker.

Due to this type of connection, the cabling becomes very complex which means more effort in case of repair. The actual weak point of this kind of speaker arrangement is that all speakers must have the same power values, otherwise individual speakers will be overloaded.

Failure of one speaker also means failure of 3 further speakers at the same time. Besides, such a speaker system can only be extended with great difficulty.

## How to Solve these Problems?

If speaker systems are used with a transformer which is built in or connected ahead, all speakers can be connected in parallel. Each speaker only picks up the power from the 100 V line which is adjusted at the transformer. Thus, it is possible to interconnect speakers of different power ratings without any problems.

The total power is calculated from the total of all connected speakers.

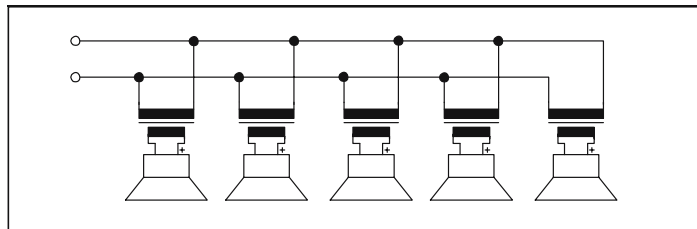

## An Example:

A PA system for a sports facility.

The following speakers are selected for this purpose:

- 2 x 15 W for the outdoor facility
- 4 x 15 W for the gym
- 6 x 2 W for the changing rooms and sanitary rooms

This results in a required total power of **102 W**.

When choosing the amplifier, please ensure that the value indicated as output power is higher than the required total power. In our calculation example a **PA-1200** with an output power of 120 W could be used.

**NOTE!** We recommend to plan a reserve for the amplifier output power so that subsequent extensions can be made without any problems.

## Laying Speaker Cables as a Ring Line

The speakers are generally connected in parallel to a line coming from the amplifier. The line ends at the last speaker. From a technical point of view, this is not a problem. With regard to the operating reliability, however, this method is not the perfect solution. In case the line is interrupted anywhere along A or B, every speaker situated behind that point will no longer operate.

However, if the line is fed from the last speaker back to the amplifier (indicated in red) and then connected to the line coming from it with the right polarity, the operating reliability is increased considerably. An interruption at one of the points would not result in a failure of a speaker, anymore.

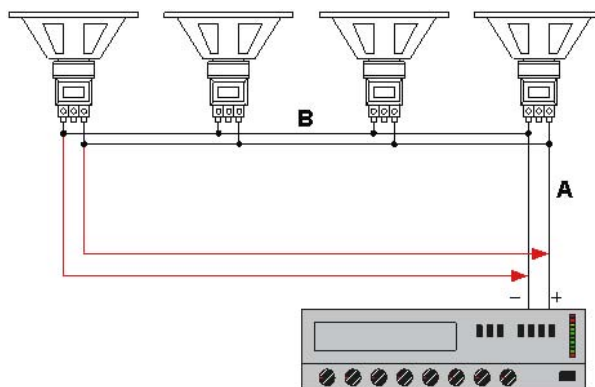

## Configuration with Different Speakers

It frequently happens that both 100 V speakers and low-impedance speakers are to be connected to a 100 V PA system at the same time.

This has to be avoided in any case, as the amplifier will be overloaded. In case of optimum level control, both the low-impedance

speaker and the 100 V speaker would each require the maximum amplifier power.

A destruction of the amplifier will be the result. It is better to switch a 100 V transformer ahead of the low impedance speaker.



**PA-4240**

Order No. 17.0820

**PA-4120**

Order No. 17.0810



**PA power amplifiers**

- 4 x 240W<sub>RMS</sub> (PA-4240)
- 4 x 120W<sub>RMS</sub> (PA-4120)
- Routing switches for parallel operation on 2 channels each
- Temperature-controlled fan
- Connection for external on/off switch
- LED display for clip, protect, excess temperature and output level
- Mains operation or 24V emergency power operation

Model	PA-4240	PA-4120
Output power	4 x 240W <sub>RMS</sub>	4 x 120W <sub>RMS</sub>
Input sensitivity	1.2V, bal.	1.2V, bal.
Output impedance	31V/4Ω, 50V/10.4Ω, 70V/20Ω, 100V/42Ω	22V/4Ω, 50V/21Ω, 70V/41Ω, 100V/83Ω
Frequency range	55-17,000Hz, -3dB	55-17,000Hz, -3dB
S/N ratio	> 90dB, A-weighted	> 90dB, A-weighted
THD	< 1%	< 1%
High-pass filter		
Admiss. ambient temp.	0-40 °C	0-40 °C
Power supply	230V~/50Hz/2,720VA, 24V~/113A	230V~/50Hz/1,400VA, 24V~/60A
Dimensions	483x133x370mm, 3RS	483x133x370mm, 3RS
Weight	28kg	25kg
<b>Connections</b>		
Signal input	4 x XLR	4 x XLR
Speaker output	screw terminals	screw terminals
Other features	-	-



**PA-2240**

Order No. 17.0800



**PA power amplifier**

- 2 x 240W<sub>RMS</sub>
- Routing switch for parallel operation on both channels
- Switchable 400Hz high-pass filter 6dB/oct.
- Soft start
- Temperature-controlled fan
- LED display for clip, protect, excess temperature and output level
- Mains operation or 24V emergency power operation

Model	PA-2240
Output power	2 x 240W <sub>RMS</sub>
Input sensitivity	1.2V, bal.
Output impedance	25V/2.6Ω, 44V/8Ω, 70V/20Ω, 100V/42Ω
Frequency range	35-20,000Hz, -3dB
S/N ratio	> 100dB, A-weighted
THD	< 1%
High-pass filter	400Hz, 6dB/oct.
Admiss. ambient temp.	0-40 °C
Power supply	230V~/50Hz/1,300VA, 24V~/55A
Dimensions	483x88x374mm, 2RS
Weight	18kg
<b>Connections</b>	
Signal input	2 x XLR / screw terminals
Speaker output	screw terminals
Other features	-



## PA-1960

Order No. 17.2550



### High-power mono PA amplifier

- 1 x 960W<sub>RMS</sub>
- Additional, adjustable priority input with switchable priority function
- 100V slave input for inserting the amplifier into a 100V speaker line
- Switchable 400Hz high-pass filter 6dB/oct.
- 2 insertion facilities at the rear side for option modules with the following features:

- PA-6FD: fault detection module
- PA-6FM: fault monitoring module
- Connection for external on/off switch (remote start)
- Temperature-controlled fan, continuously adjustable
- LED display for fault, protect, clip, signal, priority
- Mains operation or 24V emergency power operation

Model	PA-1960
Output power	1 x 960W <sub>RMS</sub>
Input sensitivity	0.775V/60kΩ, bal.
Output impedance	75V/5.6Ω, 85V/7.2Ω, 100V/10Ω
Frequency range	35-20,000Hz
S/N ratio	> 100dB, A-weighted
THD	< 0.4%
High-pass filter	400Hz, 6dB/oct.
Admiss. ambient temp.	0-40 °C
Power supply	230V~/50Hz/2,600VA, 24V~/80A
Dimensions	483x133x374mm, 3RS
Weight	25kg
<b>Connections</b>	
Signal input	screw terminals
Speaker output	screw terminals
Other features	-

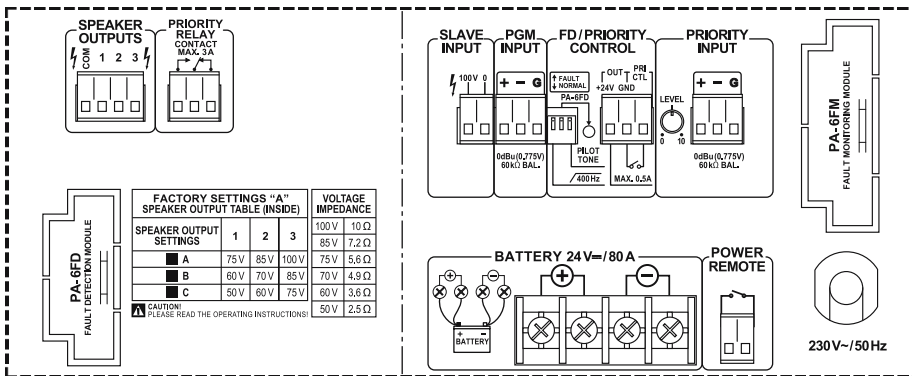

## PA-1480

Order No. 17.1110



### Mono PA power amplifier

- 1 x 480W<sub>RMS</sub>
- Switchable 400Hz high-pass filter 6dB/oct.
- Temperature-controlled fan, continuously adjustable
- LED display for clip, protect, excess temperature and output level
- Feed-through output (link)
- Mains operation or 24V emergency power operation

Model	PA-1480
Output power	1 x 480W <sub>RMS</sub>
Input sensitivity	1.2V, bal.
Output impedance	62V/8Ω, 70V/10Ω, 100V/21Ω
Frequency range	35-20,000Hz, -3dB
S/N ratio	> 100dB, A-weighted
THD	< 1%
High-pass filter	400Hz, 6dB/oct.
Admiss. ambient temp.	0-40 °C
Power supply	230V~/50Hz/1,400VA, 24V~/40A
Dimensions	483x88x374mm, 2RS
Weight	17.5kg
<b>Connections</b>	
Signal input	XLR / screw terminals
Speaker output	screw terminals
Other features	-



## PA-1242

Order No. 17.2780



### Mono PA power amplifier

- 1 x 240W<sub>RMS</sub>
- Switchable 400Hz high-pass filter 6dB/oct.
- Temperature-controlled fan, continuously adjustable
- LED display for clip, protect, excess temperature and output level
- Feed-through output (link)
- Mains operation or 24V emergency power operation

Model	PA-1242
Output power	1 x 240W <sub>RMS</sub>
Input sensitivity	1.2V, bal.
Output impedance	25V/2.6Ω, 70V/20Ω, 100V/42Ω
Frequency range	35-20,000Hz, -3dB
S/N ratio	> 100dB, A-weighted
THD	< 1%
High-pass filter	400Hz, 6dB/oct.
Admiss. ambient temp.	0-40 °C
Power supply	230V~/50Hz/750VA, 24V~/20A
Dimensions	483x88x374mm, 2RS
Weight	12.5kg
<b>Connections</b>	
Signal input	XLR / screw terminals
Speaker output	screw terminals
Other features	-



## PA-1122

Order No. 17.1020



### Mono PA power amplifier

- 1 x 120W<sub>RMS</sub>
- Switchable 400Hz high-pass filter 6dB/oct.
- Temperature-controlled fan, continuously adjustable
- LED display for clip, protect, excess temperature and output level
- Feed-through output (link)
- Mains operation or 24V emergency power operation

Model	PA-1122
Output power	1 x 120W <sub>RMS</sub>
Input sensitivity	1.2V, bal.
Output impedance	25V/5Ω, 31V/8Ω, 70V/41Ω, 100V/83Ω
Frequency range	35-20,000Hz, -3dB
S/N ratio	> 100dB, A-weighted
THD	< 1%
High-pass filter	400Hz, 6dB/oct.
Admiss. ambient temp.	0-40 °C
Power supply	230V~/50Hz/340VA, 24V~/10A
Dimensions	483x88x374mm, 2RS
Weight	12kg
<b>Connections</b>	
Signal input	XLR / screw terminals
Speaker output	screw terminals
Other features	-

## Voice Alarm Systems According to EN 60849

PA systems are no longer merely applied as intercom systems or for background music. Nowadays, they are often integrated into an extensive security concept as an essential component.

It is mostly assumed that a building has to be evacuated in case of a fire. In this case, a detection system ensures that all relevant rooms are monitored. However, in case of an alarm, the system itself can only activate sirens. Attention is definitely drawn to the sirens, but there are no specific instructions given to the people on how to act. Alerting the people via a voice message allows to specifically pass on information and to evacuate the people who are staying in the danger zone at that time.

In order to achieve a uniform standard, the European standard EN 60849 and the standards included within which have been effective since April 1998, state that certain buildings must be equipped with a voice alarm system to allow for an evacuation of the people in case of an emergency. The EN 60849 is a system standard and thus contains general standards which the ready fitted system must comply with. The included standards state the minimum requirements made on the individual products as well as the objective speech intelligibility.

With the implementation of the standard EN 60849, voice alarm systems are compulsory for buildings which exceed a certain size or for places of public assembly which exceed a certain number of people.

In Germany, this applies to e.g.

- Shops with a size of more than 2,000 m<sup>2</sup>
- Places of public assembly exceeding 200 people
- Sports facilities for more than 500 people
- Hospitals
- Schools
- Accommodation centres

Type and size of such a building may vary slightly, because national regulations of the individual EU Member State have to be complied with in addition to these standards.

Due to the integration into the security concept of a building, a faultless operation of all of the applied units has to be ensured at all times, of course. Thus, all relevant units and connections must be monitored continuously. In case of a serious fault, an error message must indicate the problem. This is usually done by a NO relay contact. This contact may activate a dialling unit, for example, in order to alert the appropriate security personnel.

### The main points of the monitoring are:

#### Speaker Circuits

In case of a failure, the sound pressure in one section may only decrease by 3 dB at the most. This means, that only half of the speaker capability is allowed to fail. The speaker circuits are monitored for short circuit, ground fault, interruption, impedance deviations and thus failure of the speakers.

With the A/B wiring, the speakers of one circuit are divided into two individual paths. Both paths are monitored for faults individually and in case one occurs, are disconnected separately from the amplifier. Thus, it is ensured that in case one path fails to operate, it does not result in a total failure of the complete circuit. In order to achieve this, it is assumed that the load for both output paths (A/B) within one circuit is almost equal when dividing the power rating of the speakers.

#### Monitoring the Amplifiers with Emergency Switching

The applied amplifiers are monitored by means of a pilot tone. In case, this tone is missing at the output of the amplifier, it will automatically be switched to a spare amplifier. The spare amplifier must be as big as the individual amplifier with the highest power capability of the system.

#### Digital Voice Storage for the Alarm Messages

The alarm messages must be stored in a non-volatile memory.

#### Monitoring of Firemen's Microphones

The fire brigade usually requires a separate microphone with the highest priority directly at the access of the fire brigade. This microphone must be specifically monitored. In addition to the connected leads, the microphone cartridge itself has to be continuously monitored, too.

#### Alarm Inputs

The connection between the fire detection system and the PA system must continuously be monitored for interruption and short circuit.

#### An Emergency Power Supply is Compulsory

In order to ensure an operation also in case the main power supply fails, a 24 V emergency power supply is compulsory. The power failure bridging time is generally set by the approval authorities.

#### MEVAC-4 as a Controller

With the **MEVAC-4** as a central controller, a very compact PA system for voice alarm systems can be realised. The features of the **MEVAC-4** are according to the requirements of EN 60849.

This has also been certified by the Technical Inspection Agency Saarland, Germany.

In case of no malfunctioning, such an intended system is also allowed to be operated as a sole PA system. Thus, the MEVAC-4 features inputs for background music, a switchable aux input as well as inputs for recalling a previously stored message. This allows to realise up to 4 speaker circuits.

The basic set-up is illustrated in the diagram on page E 17.





**MEVAC-4**  
Order No. 17.2670



**Evacuation controller**, for voice alarm systems according to EN 60849 (VDE 0828). As a central controller, the MEVAC-4 can carry out numerous functions:

- Monitoring of the speaker lines
  - Monitoring of the amplifiers with emergency switching (for 4 amplifiers and 1 spare amplifier)
  - Digital voice storage for alarm announcements
  - Monitoring of fireman's microphones
  - Distributor for audio input signals like microphone and background music
  - 4 independently addressable announcement circuits in A/B wiring
  - Fault signalling via relay contacts
- Additional features:
- Connection for any number of emergency announcement microphones (1-channel or 4-channel)

- Extensive inputs and outputs for monitoring and signalling
- State-of-the-art DSP technology, updatable
- Programming simply done via mom. push-buttons and built-in display
- Input for background music
- Aux input to be activated via external contact
- Tone control and volume control for each amplifier channel
- Background music is automatically switched off with 24V operation
- Bass attenuation in case of an alarm
- RS-232 connection for programming and updating
- Power supply: 230V~/50Hz/20VA or 24V~/500mA
- Dimensions: 482x44x315mm (1RS)
- Weight: 5kg
- Mains operation and 24V emergency power operation



**MEVAC-4PTT**  
Order No. 23.5600

**PA desktop microphone (push-to-talk)**, for the connection to evacuation controller MEVAC-4.

- 4 call zone push-buttons
- Push-button for all-call function
- Ready to call indication via LED
- Gooseneck with dynamic microphone cartridge
- 1.8m connection cable with 9-pole D-SUB plug



**MEVAC-1PTT**  
Order No. 23.5570

**PA desktop microphone (push-to-talk)**, for the connection to evacuation controller MEVAC-4.

- Programmable push-button for all-call function or individual zone
- Ready to call indication via LED
- Gooseneck with dynamic microphone cartridge
- 1.8m connection cable with 9-pole D-SUB plug



**MEVAC-1FT**  
Order No. 23.5590

**PA desktop microphone**, for emergency announcements acc. to EN 60849.

- For the connection to evacuation controller MEVAC-4
- Monitored microphone cartridge and request line
- Push-to-talk button
- Gooseneck with dynamic microphone cartridge
- Red metal housing (fireman's microphone)
- 1.8m connection cable with 5-pole DIN plug



**MEVAC-1FH**  
Order No. 23.5580

**Hand-held PA microphone**, for emergency announcements according to EN 60849.

- For the connection to evacuation controller MEVAC-4
- Monitored microphone cartridge and request line
- Push-to-talk button
- Red plastic housing (fireman's microphone) with dynamic microphone cartridge and steel clip
- 1m helix connection cable with 5-pole DIN plug



**MEVAC-1CON**  
Order No. 17.2750

**Connection outlet**, for hand-held PA microphone MEVAC-1FH or PA desktop microphone MEVAC-1FT.

- 5-pole DIN jack
- Flush mounting in standard 60mm wall sockets
- Surface mounting with supplied surface-mount housing
- Dimensions: 80x80x37mm



**MEVAC-2CON**  
Order No. 17.2760

**Connection outlet**, for PA desktop microphone (push-to-talk) MEVAC-1PTT or MEVAC-4PTT.

- 9-pole D-Sub jack
- Flush mounting in standard 60mm wall sockets
- Surface mounting with supplied surface-mount housing
- Dimensions: 80x80x37mm



# KNOW-HOW: Example of Application: MEVAC System

# KNOW-HOW KNOW-HOW

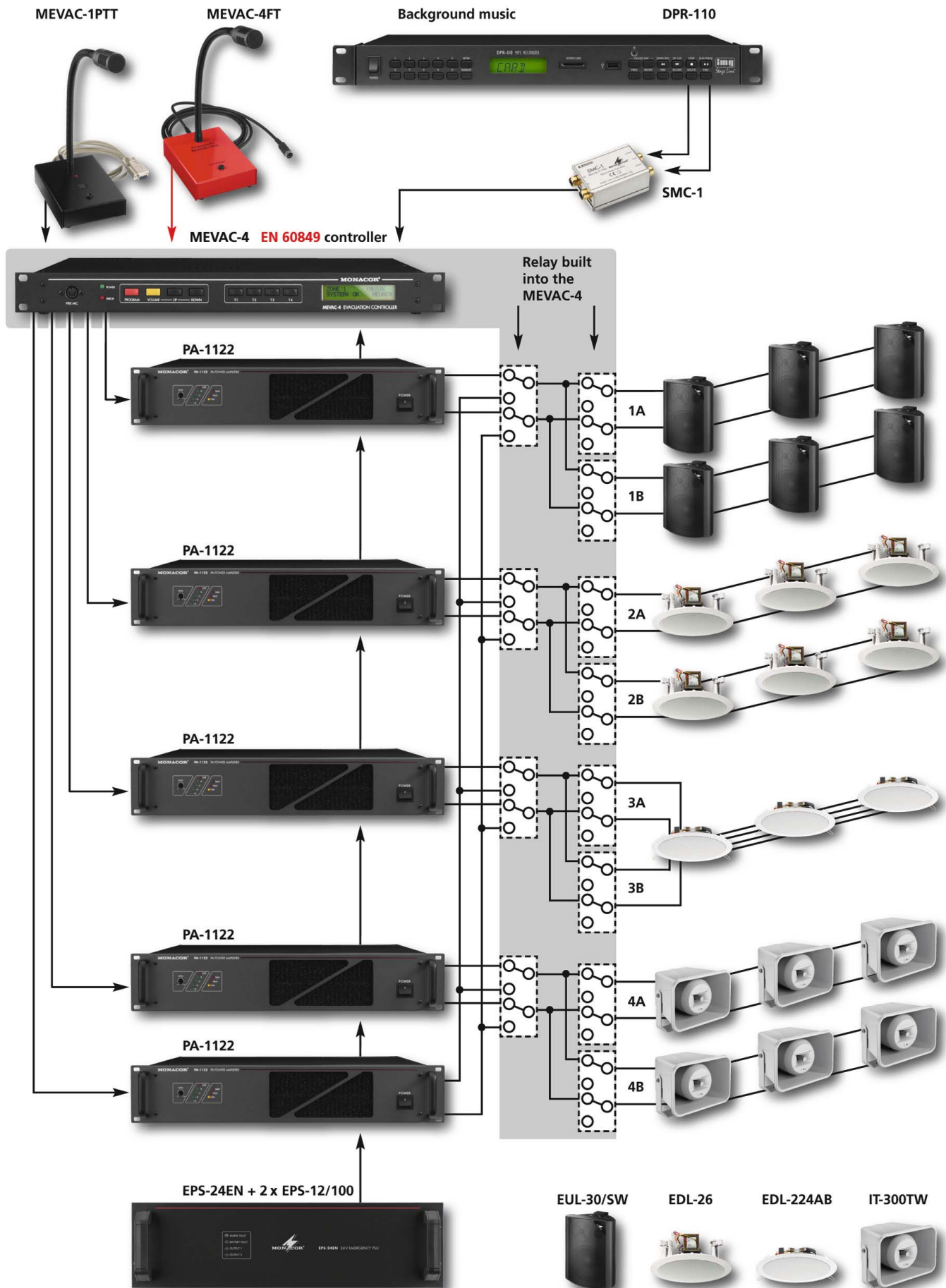



## EPS-24EN

Order No. 17.3140



**Certified charging controller for evacuation systems**, for setting up a standardised emergency power supply. Suitable for any PA component with 24V connection.

- Certified according to EN54-4
- 2 x output 24V $\approx$ /50A
- Charging current: 12A max.
- Electronic charging control of the connected rechargeable lead batteries
- Constant monitoring of all primary and secondary input voltages
- Status indication via LED
- Deep discharge protection
- 2 alarm outputs
- Screw terminals for 2 external rechargeable lead batteries EPS-12/100
- Supplied with cable set for connecting 2 x EPS-12/100
- Power supply: 230V~/50Hz/460VA
- Dimensions: 482x132x400mm
- Weight: 7.7kg

Matching rechargeable lead batteries EPS-12/100 (2x) are available at option.



## EPS-12/100

Order No. 17.3120



**Rechargeable lead battery, 12V**, for charging controller EPS-24EN.

- Power rating: 12V/100Ah
- Dimensions: 505x111x240mm
- Weight: 37kg
- 2 EPS-12/100 are required for an operation with EPS-24EN



### PA-24ESP

Order No. 24.3120



**24V emergency PSU**, suitable for our PA components with 24V connection.

- Installation of 2 x rechargeable lead battery NPA-12/24 possible
- Screw connection for external 24V rechargeable batteries
- Max. charging current: 2.5A

- Electronic charging control with overload protection, protection against total discharge and trickle charge
- 1 x output 24V~/1A (unswitched)
- 2 x output 24V~/32A
- 3 x output 24V~/16A
- Power supply: 230V~/50Hz/110VA
- Dimensions: 482x135x405mm
- Weight: 11.7kg



### PA-2460CD

Order No. 21.2780



**6 CD and MP3 CD changer**

- Supports WMA
- Folder navigation
- 24-track programming
- Repeat function
- Random play
- Track or disc scan function
- Optional 24V emergency power operation

- LCD
- Cheque-card-sized infrared remote control
- Outputs:
  - Stereo XLR, bal.
  - Mono XLR, bal.
  - Stereo RCA
  - Digital output, coaxial and optical
- Audio CD/CD-R/MP3 CD

Model	PA-2460CD
<b>General information</b>	changer, 6 CDs
Frequency range	20-20,000Hz, ±3dB
THD	< 0.03%
Channel separation	> 70dB
Dynamic range	> 70dB
S/N ratio	> 85dB
Wow and flutter	not measurable
Output, analog	0.775V
Output, digital	0.5V <sub>pp</sub> S/PDIF
Power supply	230V~/50Hz/20VA or 24V~/1.5A
Dimensions, player mech.	482x88x260mm, 2RS
Dimensions, control panel	-
Weight	7.1kg
<b>Connections</b>	
Analog output	1 x RCA L/R 3 x XLR, bal.
Digital output	1 x RCA 1 x Toslink



## PA-24FR

Order No. 17.2580



### 2-channel anti-feedback controller

- Efficient protection against acoustic feedback due to frequency shift method
- Selectable frequency shift 3-15Hz, adjustable in 13 steps via DIP switches
- Integrated noise gate (mute when input level is too low)
- Bypass function
- LED display for operation, input signals and activated frequency shift function

- XLR connections and screw connections for line inputs and outputs

Model	PA-24FR
Inputs	0.775V, 60kΩ, bal.
Outputs	0.775V, 50Ω, bal.
Frequency range	20-20,000Hz
S/N ratio	> 70dB
THD	< 0.05%
Power supply	230V~/50Hz/10VA
Dimensions	482x44x230mm, 1R5
Weight	2.4kg

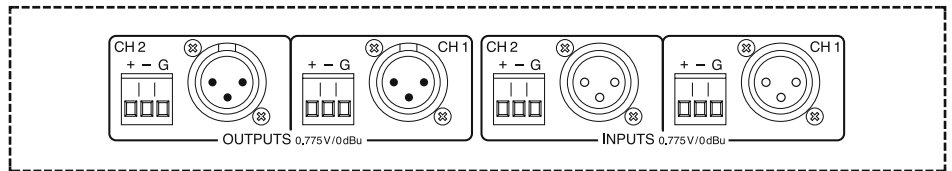

## MFE-16M

Order No. 25.3330



### Stereo DSP feedback controller

- Prevents acoustic feedback appearing in PA systems
- 12 steep-edged precision notch filters for each stereo channel (resolution: 24 bits)
- 30dB attenuation (with gradual reduction in automatic mode)
- Optionally continuous signal monitoring (auto scan) or manual setting of the required filters (hold filters)
- AD/DA resolution: 20 bits
- Adjustable input level, output level and sensitivity
- Bypass function
- Clip LED

- Optionally mono or stereo operation possible
- Stable extruded aluminium housing
- Suitable for general applications due to compact design
- Power supply via supplied plug-in PSU



Model	MFE-16M
<b>General information</b>	
Frequency range	20-20,000Hz
Inputs	2.2V max.
Outputs	2.2V max.
S/N ratio	> 90dB
THD	< 0.01%
Power supply	via suppl. plug-in PSU
Admiss. ambient temp.	0-40 °C
Dimensions	140x45x125mm
Weight	650g
<b>Inputs</b>	
Mic/line	1 x 6.3mm jack L/R
Foot pedal	-
<b>Outputs</b>	
Mic/line	1 x 6.3mm jack L/R

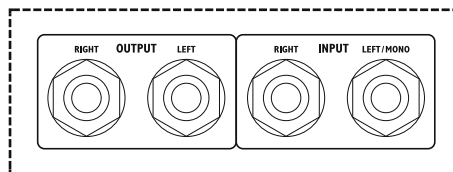

## PA-24FMU

Order No. 17.2570



### PA emergency sound system, for integrating into PA systems according to EN 60849.

- Hand-held microphone with monitored functionality
- Alarm input for triggering alarm
- Integrated digital voice storage (60 seconds max.) with microphone input or line input for recording messages
- Recorded message is also kept without operating voltage

- Siren emits an acoustic signal for 10 seconds when alarm is triggered, volume control
- Built-in signal light FIRE flashes when alarm is triggered
- Balanced line output via spring-loaded terminal
- 24V power supply via PSS-3800SV, available at option

Model	PA-24FMU
Output level	1.23V/600Ω, bal.
Siren frequency	800Hz
Max. recording time	60 seconds
Power supply	24V~/200mA
Dimensions	482x88x200mm, 2R5
Weight	3kg

# Monitor Unit, Matrix Router, Line Splitter



**PA-1200M**  
Order No. 24.0260



**Monitor unit, 10 + 1 channels**

- Audio sources can be selected via rotary switch
- 10 monitor inputs 1-100V/10kΩ
- 1 aux input 0dB (0.775V)/600Ω
- Level control, LED VU meter and clip LED for each monitor input
- Built-in 2W speaker, volume control
- Headphone output: ≥ 8Ω, 0.1W

- Frequency range: 100-20,000Hz
- THD: < 0.3%
- Power supply: 230V~/50Hz/15VA or 24V~/0.5A
- Dimensions: 482x88x200mm, 2RS
- Weight: 4.7kg
- Mains operation and 24V emergency power operation



**ARM-88**  
Order No. 17.3050



**Audio matrix router, matrix with 8 inputs and 8 outputs.**

- Each input can be routed to any output as desired
- Processor-controlled
- Easy-to-use
- 8 presets can be stored and recalled
- Adjustable output level

- Balanced XLR inputs and XLR outputs
- 482mm (19") rack installation, 1RS

**PROSOUND 06/2009**

"A very efficient tool for any PA system. The best feature of this device: It really provides what is actually needed."

Model	ARM-88
Input voltage	7V max.
Output voltage	7V max.
Input impedance	30kΩ bal., 15kΩ unbal.
Output impedance	200Ω bal., 100Ω unbal.
Amplification factor	0-2 continuously adjustable
S/N ratio	64dB
Power supply	230V~/50Hz/20VA
Dimensions	482x45x240mm, 1RS
Weight	2.6kg

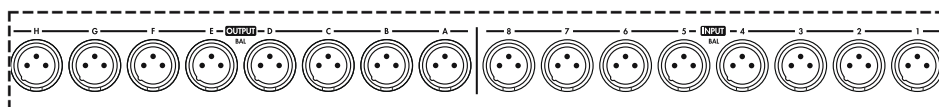

**PA-24AD**  
Order No. 17.1890



**10-way PA line splitter**

- 2 separate inputs
- Stereo operation or mono operation

- Balanced XLR connection for each input and output
- Gain control for each output
- Peak indication for each input
- Mains operation and 24V emergency power operation

Model	PA-24AD
Line inputs, mono	0.775V/15kΩ
Line outputs, mono	0.775V/600Ω
Frequency range	20-20,000Hz
THD	< 0.05%
S/N ratio	> 68dB
Power supply	230V~/50Hz/10VA 24V~/0.2A
Admiss. ambient temp.	0-40 °C
Dimensions	482x45x235mm, 1RS
Weight	3.1kg

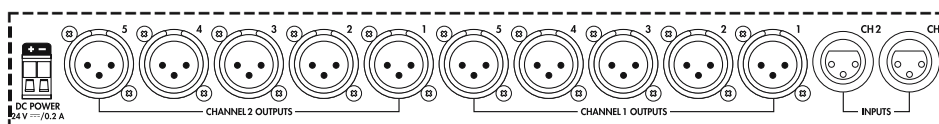



## PA-100ANC

Order No. 17.2280



**Ambient noise controller**, for automatically matching the signal in case of ambient noise. The wanted audio signal is held at a fixed distance to a second audio signal. The second audio signal is usually the ambient noise which normally appears in shopping centres, hotels, train stations, airports or restaurants. The supplied noise detector and a microphone (available at option) monitor the ambient noise and the wanted signal (e.g. announcement or music) is boosted or attenuated accordingly. Thus, the signal for announcements or music is, at the set level, always at a higher volume than the ambient noise.

- Supplied with noise detector for the connection of an electret microphone or a

dynamic microphone with XLR jack or 6.3mm jack

- Adjustable limiter for setting the low output level
- Adjustable Q-factor
- Adjustable band filter for measuring (30-15,000Hz)
- Bypass switch for deactivating the noise detector
- Phantom power can be switched on additionally via noise detector
- LED display for output level and clipping
- 24V emergency power supply

Matching microphones DM-2500, ECM-302B/WS, ECM-10/SW or ECM-10/WS are available at option.

Model	PA-100ANC
Input	0.775V, 30kΩ, bal., XLR
Output	0.775V, 600Ω, bal., XLR
S/N ratio	> 60dB
Frequency range	20-20,000Hz
THD	< 0.3%
Phantom power	20V=
Power supply	230V~/50Hz/10VA 24V~/150mA
Dimensions	482x44x230mm, 1RS
Weight	80x60x180mm (noise detector) 3.5kg (in total)



*including noise detector*



## VCA-202

Order No. 17.1880



**Voltage-controlled 2-channel VCA volume control**

- 2-channel mono or stereo operation
- Remote control for each channel via optional wall-mount volume control VCA-202RN or via lin. 10kΩ potentiometer (not supplied), control voltage: 0-10V=
- 10V voltage output for potentiometer
- Servo-balanced inputs and outputs
- 482mm (19") rack installation, 1RS

For the remote volume control of PA systems in large areas (e.g. churches, workshops). The volume control VCA-202 is inserted between preamplifier and power amplifier. The surface-mount housing ATT-300 can be used for universal mounting of the potentiometers.

Model	VCA-202
Line input, mono	1V/30kΩ
Input control voltage	0-10V=/100kΩ
Line output, mono	1V/600Ω
Output control voltage	10V=/5mA
Frequency range	20-20,000Hz
THD	0.1%
S/N ratio	70dB
Power supply	230V~/50Hz/10VA
Admiss. ambient temp.	0-40 °C
Dimensions	482x48x105mm, 1RS
Weight	1.5kg
Line input, mono	2 x XLR, bal.
Input control voltage	screw plug-in connection
Line output, mono	2 x XLR, bal.
Output control voltage	screw plug-in connection

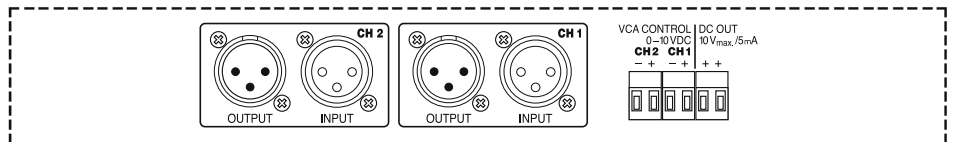

## VCA-202RN

Order No. 17.3000

**Wall-mount volume control**, for the use with VCA-202 or similar.

- Linear 10kΩ potentiometer, mono
- Built-in relay (24V=) for priority circuit
- Flush mounting in standard 60mm wall socket
- Surface mounting with matching housing ATT-300, available at option
- Mounting depth: 27mm
- Screw plug-in connection



## The Role of Insert Jacks

Time and again it is necessary to insert additional units like equalizers into a signal way. This is not a problem with systems set up separately with individual mixers and power amplifiers. In this case, the signal cables are simply connected to the units. This is different with compact full amplifiers, as they are customary for PA applications. In this case, the separation is done by special jacks. With these combination jacks, it is possible to separate the preamplifier with the inputs (PRE OUT) from the mere power amplifier (AMP IN). The illustration shows the outputs by example of the **PA-1120** amplifier. Due to the ability to separate, it is now possible to insert additional units into the signal way.

Two examples of such additional units and their features are shown below.

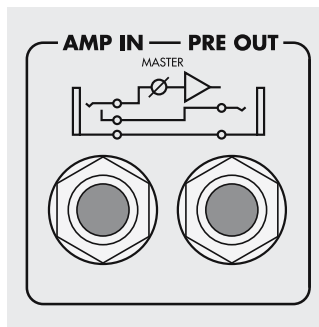

## Automatic Volume Control with PA-100ANC

By using this ambient noise controller, it is possible to achieve a signal volume depending on the ambient noise. To put it more simple, the louder the surrounding, the more signal is fed to the speakers.

In practical application it is possible, e.g. to match the volume of the background music in a restaurant automatically to the noise level of the rooms. This adjustment is usually slightly delayed and attenuated, so that short noise peaks will not have any effect on the volume control.

A microphone is additionally required for the **PA-100ANC**.

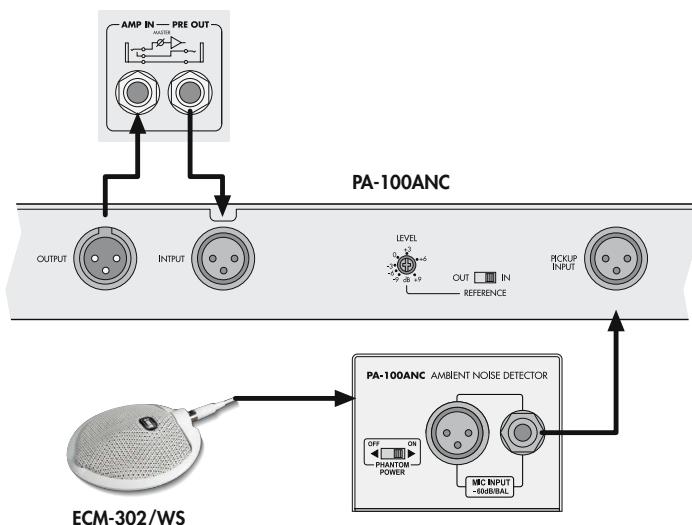

## Remote Volume Control with VCA-202

The remote volume control is a further requirement which often has to be met. This is always the case, if the system is not set up at a location where staff is nearby. For this purpose, previous solutions included the adjustment of the speaker outputs. With the **VCA-202** and **VCA-202RN**, the amplifier output power can now easily be adjusted remotely. The **VCA-202** is also inserted between preamplifier and power amplifier. This could be a compact PA amplifier, a mixer with separate power amplifier or also a CD player and a power amplifier.

A basic cable with a minimum of 3 wires connects the control unit and the **VCA-202**. Because this cable does not carry an AF signal, shielding is not compulsory. If both inputs of the **VCA-202** are used, the volume adjustments can either be done together via one control or separately via two controls.

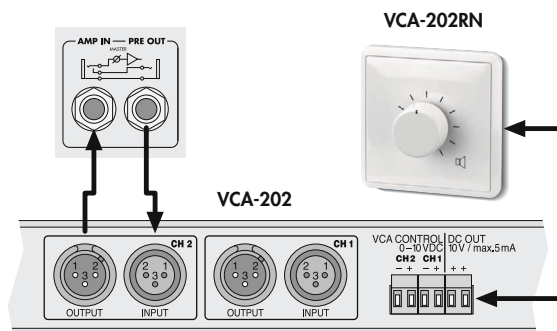





**PA-980**

Order No. 17.2900



**Mono PA mixing amplifier**

- 1 x 480W<sub>RMS</sub>
- 4 balanced mic/line inputs
- Mic 1 with priority circuit and automatic talkover
- Additional connection for desktop microphone via screw terminal
- 1 aux input

- Speaker outputs via screw terminals
- Line output
- Insert facility for preamplifier
- Input and output level controls
- 2-way tone control for the output
- 21V phantom power, selectable
- Temperature-controlled fan, continuously adjustable
- Mains operation or 24V emergency power operation

Model	PA-980
Output power	480W <sub>RMS</sub> , 680W <sub>MAX</sub>
Mic input	1.5mV
Aux input	300mV
Phono input	-
Speaker output	4Ω, 70/100V
Frequency range	50-15,000Hz, ±3dB
Equalizer bass	±10dB/100Hz
Equalizer midrange	-
Equalizer treble	±10dB/10kHz
S/N ratio	> 92dB
THD	< 2%
Power supply	230V~/50Hz/1,350VA, 24V=14A
Admiss. ambient temp.	0-40 °C
Dimensions	482x135x410mm, 3RS
Weight	26kg
Special feature	
<b>Inputs</b>	
Microphone/line	4 x XLR
Aux	1 x RCA L/R (aux)

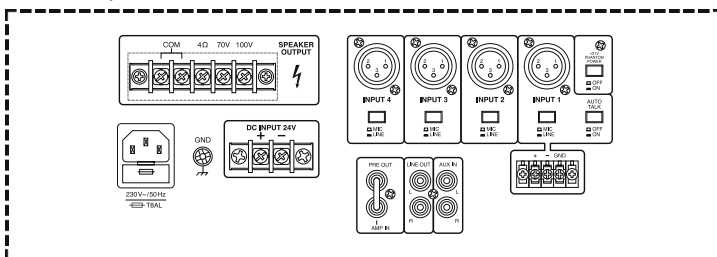

**PA-940**

Order No. 17.2090



**Mono PA mixing amplifier**

- 1 x 240W<sub>RMS</sub>
- 4 balanced mic/line inputs
- Mic 1 with priority circuit and automatic talkover
- Additional connection for desktop microphone via screw terminal
- 1 aux input

- Speaker outputs via screw terminals
- Line output
- Insert facility for preamplifier
- Input and output level controls
- 2-way tone control for the output
- 21V phantom power, selectable
- Temperature-controlled fan, contin. adj.
- Mains operation or 24V emergency power operation
- Removable mounting brackets

Model	PA-940
Output power	240W <sub>RMS</sub> , 340W <sub>MAX</sub>
Mic input	1.5mV
Aux input	300mV
Phono input	-
Speaker output	4Ω, 70/100V
Frequency range	50-15,000Hz, ±3dB
Equalizer bass	±10dB/100Hz
Equalizer midrange	-
Equalizer treble	±10dB/10kHz
S/N ratio	> 92dB
THD	< 2%
Power supply	230V~/50Hz/520VA, 24V=18A
Admiss. ambient temp.	0-40 °C
Dimensions	482x135x380mm, 3RS
Weight	19.5kg
Special feature	
<b>Inputs</b>	
Microphone/line	4 x XLR
Aux	1 x RCA L/R (aux)

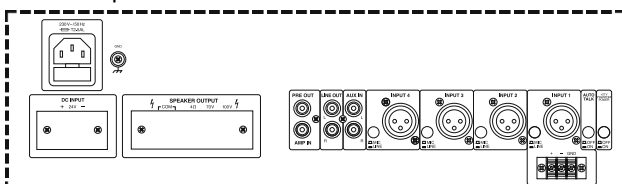



## PA-906

Order No. 17.3170



### Mono PA mixing amplifier

- 1 x 120W<sub>RMS</sub>
- 6 inputs via comb. jacks mic (XLR)/line (6.3mm)
- 6 inputs via stereo RCA jacks
- Mic 1 and mic 2 with priority circuit
- Additional connection for desktop microphone via screw terminal
- Chime feature for input channel 1
- Speaker outputs via screw terminals

- Additional 6.3mm jack connections for low-impedance speakers
- Slave output
- Insert facility for preamplifier
- Input and output level controls
- 2-way tone control for the output
- Phantom power: 48V, can be switched for each input
- 482mm (19") rack installation with supplied mounting brackets
- Mains operation or 24V emergency power operation

Model	PA-906
Output power	120W <sub>RMS</sub> , 160W <sub>MAX</sub>
Mic input	1.5mV/5kΩ (bal.)
	26mV/5kΩ (unbal.)
Line input	270mV/10kΩ (bal.)
	300mV/10kΩ (unbal.)
Speaker output	8/16Ω, 70/100V
Frequency range	100-15,000Hz, ± 3dB
Equalizer bass	± 10dB/100Hz
Equalizer midrange	-
Equalizer treble	±10dB/10kHz
S/N ratio	> 92dB
THD	< 2%
Power supply	230V~/50Hz/320VA, 24V=7A
Admiss. ambient temp.	0-40 °C
Dimensions	430x88x340mm, 2RS
Weight	12kg
<b>Inputs</b>	6 x XLR, bal. (mic./line)
	6 x 6.3mm jack, unbal. (mic./line)
	6 x RCA L/R (line)

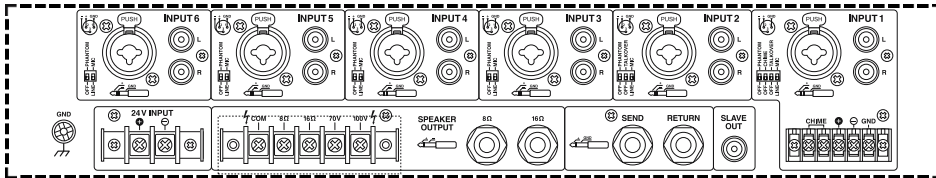

## PA-900WP

Order No. 17.3190



### Drip-water protected mono PA mixing amplifier

- Protected against dripping water (IP21) due to coated PCBs, sealed potentiometers, transformers with protective coating, galvanised metal parts and screws made of stainless steel
- 1 x 120W<sub>RMS</sub>
- 4 balanced mic/line inputs
- Mic 1 with priority circuit and automatic talkover

- Additional connection for desktop microphone via screw terminal
- 1 aux input
- Speaker outputs via screw terminals
- Line output
- Insert facility for preamplifier
- Input and output level controls
- 2-way tone control for the output
- 21V phantom power, selectable
- Metal housing with white powder coating
- 482mm (19") rack installation with supplied mounting brackets
- Mains operation or 24V emergency power operation

Model	PA-900WP
Output power	120W <sub>RMS</sub> , 160W <sub>MAX</sub>
Mic input	1.5mV
Aux input	300mV
Phono input	-
Speaker output	4Ω, 70/100V
Frequency range	50-15,000Hz, ±3dB
Equalizer bass	±10dB/100Hz
Equalizer midrange	-
Equalizer treble	±10dB/10kHz
S/N ratio	> 92dB
THD	< 2%
Power supply	230V~/50Hz/300VA, 24V=9A
Admiss. ambient temp.	0-40 °C
Dimensions	430x88x275mm, 2RS
Weight	11.2kg
Special feature	
<b>Inputs</b>	
Microphone/line	4 x XLR
Aux	1 x RCA L/R (aux)

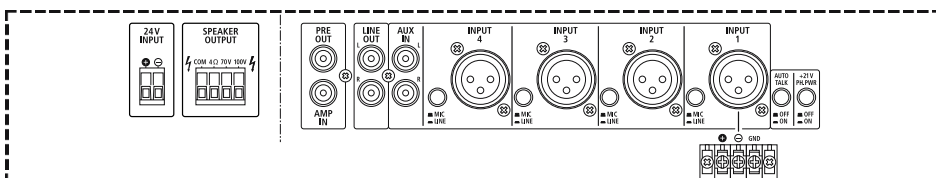



**PA-900**

Order No. 17.1190



**Mono PA mixing amplifier**

- 1 x 120W<sub>RMS</sub>
- 4 balanced mic/line inputs
- Mic 1 with priority circuit and automatic talkover
- Additional connection for desktop microphone via screw terminal
- 1 aux input
- Speaker outputs via screw terminals
- Line output

- Insert facility for preamplifier
- Input and output level controls
- 2-way tone control for the output
- 21V phantom power, selectable
- Mains operation or 24V emergency power operation
- Removable mounting brackets

Model	PA-900
Output power	120W <sub>RMS</sub> , 160W <sub>MAX</sub>
Mic input	1.5mV
Aux input	300mV
Phono input	-
Speaker output	4Ω, 70/100V
Frequency range	50-15,000Hz, ±3dB
Equalizer bass	±10dB/100Hz
Equalizer midrange	-
Equalizer treble	±10dB/10kHz
S/N ratio	> 92dB
THD	< 2%
Power supply	230V~/50Hz/300VA, 24V~/9A
Admiss. ambient temp.	0-40 °C
Dimensions	482x88x275mm, 2RS
Weight	10kg
Special feature	
<b>Inputs</b>	
Microphone/line	4 x XLR
Aux	1 x RCA L/R (aux)

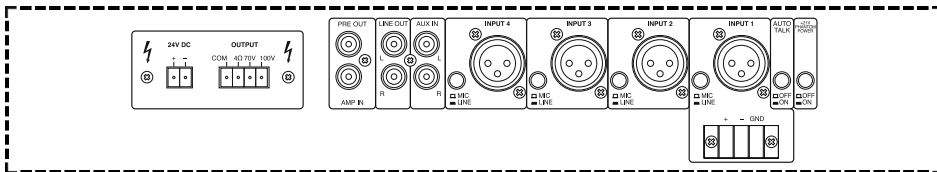

**PA-930CD**

Order No. 17.2920



**Mono PA mixing amplifier, with integrated CD player.**

- 1 x 120W<sub>RMS</sub>
- CD player with MP3 reproduction and USB interface, slot-in mechanism, random play, repeat function and track programming, reproduction of audio CD/CD-R/CD-RW/MP3 CD
- CD autostart after switching on, selectable
- 4 balanced mic/line inputs
- Mic 1 with priority circuit and automatic talkover
- Additional connection for desktop microphone via screw terminal
- 1 aux input

- Speaker outputs via screw terminals
- Line output
- Insert facility for preamplifier
- Input and output level controls
- 2-way tone control for the output
- 21V phantom power for electret microphones
- Supplied with remote control for the CD player
- 482mm (19") rack installation with supplied mounting brackets
- Mains operation or 24V emergency power operation

Model	PA-930CD
Output power	120W <sub>RMS</sub> , 160W <sub>MAX</sub>
Mic input	1.5mV
Aux input	300mV
Phono input	-
Speaker output	4Ω, 70/100V
Frequency range	50-15,000Hz, ±3dB
Equalizer bass	±10dB/100Hz
Equalizer midrange	-
Equalizer treble	±10dB/10kHz
S/N ratio	> 92dB
THD	1% (120W <sub>RMS</sub> )
Power supply	230V~/50Hz/300VA, 24V~/9A
Admiss. ambient temp.	0-40 °C
Dimensions	430x95x380mm, 2RS
Weight	11.7kg
Special feature	
<b>Inputs</b>	
Microphone/line	4 x XLR (mic, line)
Aux	1 x RCA L/R (aux)

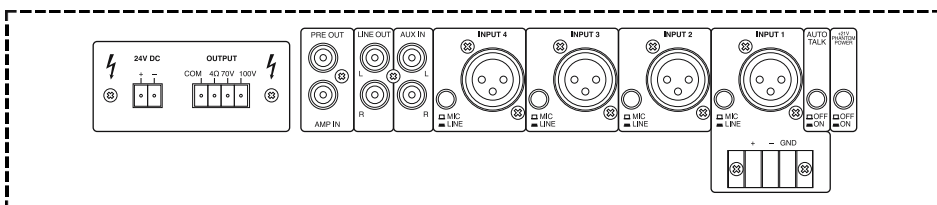



## PA-980S

Order No. 17.2910



### Mono PA power amplifier

- 1 x 480W<sub>RMS</sub>
- 2-way tone control
- Switchable low cut filter
- Speaker outputs via screw terminals

- Temperature-controlled fan, continuously adjustable
- Feed-through output (link)
- Mains operation or 24V emergency power operation

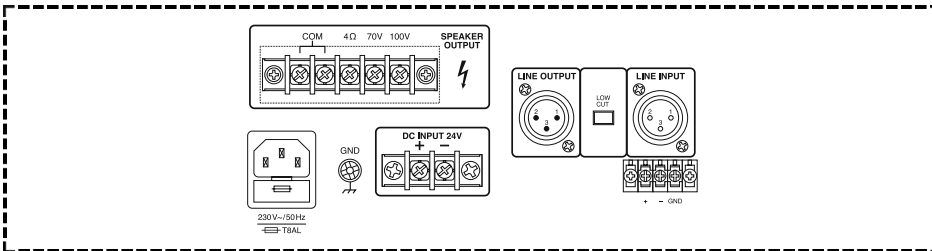

Model	PA-980S
Output power	480W <sub>RMS</sub> , 680W <sub>MAX</sub>
Input sensitivity	0.765mV/10kΩ, bal.
Speaker output	4Ω, 70/100V
Frequency range	50-15,000Hz, ±3dB
Equalizer bass	±10dB/100Hz
Equalizer treble	±10dB/10kHz
S/N ratio	> 80dB
THD	< 2%
Admiss. ambient temp.	0-40 °C
Power supply	230V~/50Hz/1,350VA, 24V=14A
Dimensions	482x135x410mm, 3RS
Weight	25.5kg
<b>Connections</b>	
Signal input	XLR / screw terminals
Speaker output	screw terminals



## PA-940S

Order No. 17.2100



### Mono PA power amplifier

- 1 x 240W<sub>RMS</sub>
- 2-way tone control
- Switchable low cut filter
- Speaker outputs via screw terminals

- Temperature-controlled fan, continuously adjustable
- Feed-through output (link)
- Mains operation or 24V emergency power operation
- 482mm (19") rack installation with supplied mounting brackets

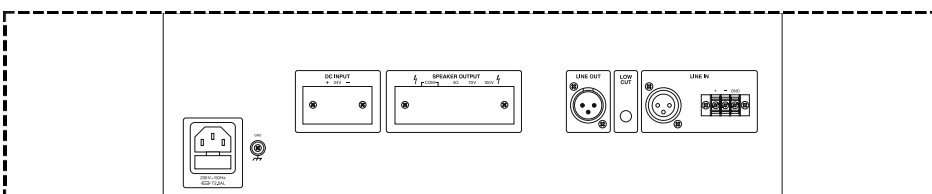

Model	PA-940S
Output power	240W <sub>RMS</sub> , 340W <sub>MAX</sub>
Input sensitivity	0.765mV/10kΩ, bal.
Speaker output	4Ω, 70/100V
Frequency range	50-15,000Hz, ±3dB
Equalizer bass	±10dB/100Hz
Equalizer treble	±10dB/10kHz
S/N ratio	> 80dB
THD	< 2%
Admiss. ambient temp.	0-40 °C
Power supply	230V~/50Hz/520VA, 24V=18A
Dimensions	482x135x380mm, 3RS
Weight	19kg
<b>Connections</b>	
Signal input	XLR / screw terminals
Speaker output	screw terminals



**PA-900S**

Order No. 17.2080



**Mono PA power amplifier**

- 1 x 120W<sub>RMS</sub>
- 2-way tone control
- Switchable low cut filter
- Speaker outputs via screw terminals
- Feed-through output (link)
- Mains operation or 24V emergency power operation
- 482mm (19") rack installation with supplied mounting brackets



Model	PA-900S
Output power	120W <sub>RMS</sub> , 160W <sub>MAX</sub>
Mic input	-
Aux input	765mV (line)
Phono input	-
Speaker output	4Ω, 70/100V
Frequency range	50-15,000Hz, ±3dB
Equalizer bass	±10dB/100Hz
Equalizer midrange	-
Equalizer treble	±10dB/10kHz
S/N ratio	> 80dB
THD	< 2%
Power supply	230V~/50Hz/300VA, 24V~/9A
Admiss. ambient temp.	0-40 °C
Dimensions	482x88x275mm, 2RS
Weight	9.5kg
Special feature	low cut filter
<b>Inputs</b>	
Line	1 x XLR, 1 x screw terminal



**STA-850D**

Order No. 25.2360



**8-channel digital amplifier**

- Class D concept
- Silent operation due to fanless cooling concept

- 8Ω bridge operation possible
- Mute function for each channel
- 8 level controls
- 1 LED per channel for indicating overload (clip)
- Protected against short circuit

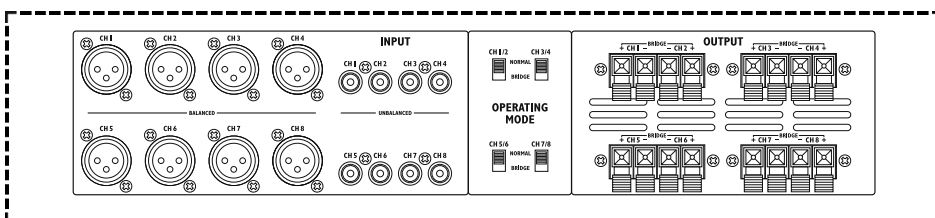

Model	STA-850D
<b>Output power</b>	
RMS power	
Stereo 4Ω	8 x 50W <sub>RMS</sub>
Stereo 8Ω	8 x 30W <sub>RMS</sub>
8Ω bridge operation	4 x 100W <sub>RMS</sub>
Max. power	600W <sub>MAX</sub>
<b>General information</b>	
Inputs	1V/20kΩ unbal. 550mV/20kΩ bal.
Frequency range	10-20,000Hz
S/N ratio	-
Crosstalk attenuation	> 45dB
THD	-
Power supply	230V~/50Hz/600VA
Admiss. amb. temp.	0-40 °C
Dimensions	483x90x330mm, 2RS
Weight	10.5kg
<b>Connections</b>	
	8 x XLR, bal.
	8 x RCA,
	8 x spring-load. speaker term. L/R

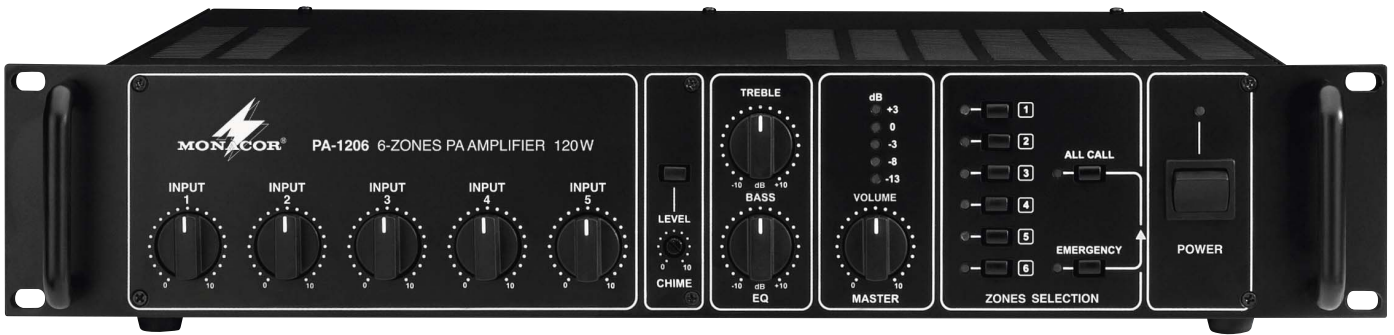

### PA-1206

Order No. 17.2480



#### 6-zone mono PA mixing amplifier

- 1 x 120W<sub>RMS</sub>
- Processor-controlled zone selection
- 6 zones, can be switched individually
- Emergency priority circuit for input channel 1, switchable
- Chime, automatic mute
- Bass, treble and master controls, level display via LEDs
- Phantom power for electret microphones can be switched on additionally
- Connection for zone paging microphone PA-1206RC
- Up to 8 x PA1206RC can be connected to each bus
- 5 balanced inputs, switchable mic/line
- Mains operation and 24V battery operation

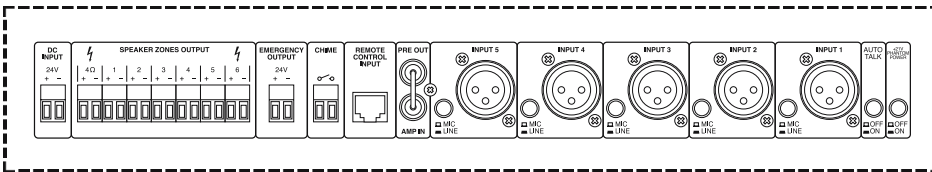

Model	PA-1206
<b>General information</b>	
Output power	120W <sub>RMS</sub> 170W <sub>MAX</sub>
Inputs	
Mic/line 1-3	1.4mV/8kΩ, 290mV/17kΩ
Preamplifier	1V
Outputs	
Speakers	6 x 100V (zones), 1 x 4Ω (direct output)
Preamplifier	1V
Frequency range	45-20,000Hz
Tone control	
Bass	±10dB/100Hz
Treble	±10dB/10kHz
S/N ratio	
Mic	> 60dB, A-weighted
Line	> 62dB, A-weighted
THD	< 1%
Admiss. ambient temp.	0-40 °C
Power supply	230V~/50Hz/300VA, 24V~/10A
Dimensions	482x88x360mm, 2RS
Weight	12kg
<b>Inputs</b>	
Mic/line	5 x XLR, bal.
PA desktop microphone	1 x RJ45
Mom. push-button for chime	screw plug-in terminals
Ext. amplifier	1 x RCA
<b>Outputs</b>	
Preamplifier	1 x RCA
Speakers	screw plug-in terminals
Emergency	screw plug-in terminals
<b>Power supply</b>	
230V~	3-pin IEC jack
24V~	screw plug-in terminals

### PA-1206RC

Order No. 23.5480

#### PA zone paging desktop microphone, for the connection to PA-1206.

- Processor-controlled
- Selector buttons for 6 zones, for activating one zone or several zones
- ALL CALL button for activating all of the 6 zones
- EMERGENCY button for starting an emergency broadcast
- Automatic chime via microphone announcement button (talk)
- LED status indications for the zone buttons, ALL CALL, EMERGENCY, POWER, BUSY and TALK
- Emergency priority circuit
- Built-in gooseneck electret microphone
- Adjustable microphone sensitivity
- Chime can additionally be switched on or off
- Power supply via PA-1206
- Two RJ45 jacks for the connection to PA-1206 and additional PA-1206RC microphones
- Up to 8 x PA-1206RC can be connected to PA-1206 via bus
- Connection cable (CAT-5...) is available at option

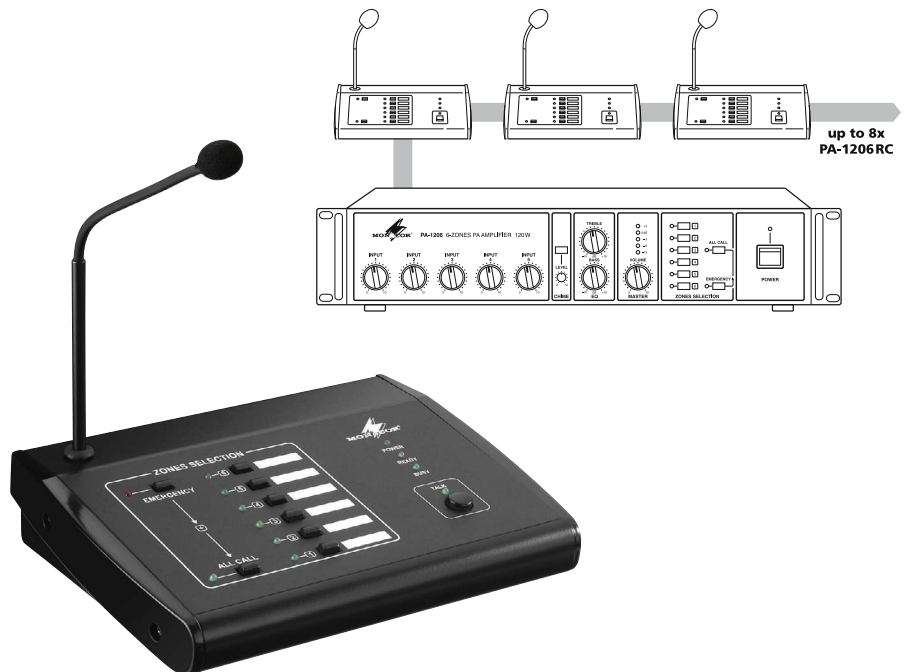



**PA-4150**

Order No. 17.3010



**Mono PA mixing amplifier,** with 4 active outputs. With this unit, all input signals are mixed together and form a common output signal which is applied identically to each of the 4 outputs.

- 4 x 150W<sub>RMS</sub>
- Each output with level control and 2-way tone control
- 4 balanced mic/line inputs and 2 aux inputs

- Additional connection for desktop microphone via screw terminal
- Chime and siren, can also be activated via external push-button
- Insert facility between preamplifier and power amplifier for additional units, e.g. anti-feedback controller PA-24FR
- Speaker outputs via screw terminals
- Phantom power 48V and high-pass filter can be switched for each input channel

Model	PA-4150
Output power	4 x 150W <sub>RMS</sub>
Mic input	2.5mV
	250mV (line)
Aux input	250mV
Phono input	-
Speaker output	4Ω, 8Ω, 70/100V
Frequency range	50-17,000Hz, ±3dB
Equalizer bass	±10dB/100Hz
Equalizer midrange	-
Equalizer treble	±10dB/10kHz
S/N ratio	> 80dB
THD	< 1%
Power supply	230V~/50Hz/1,350VA
Admiss. ambient temp.	0-40 °C
Dimensions	482x133x480mm, 3RS
Weight	22.3kg
Special feature	
<b>Inputs</b>	
Microphone/line	4 x 6.3mm/XLR (comb.)
Aux	2 x RCA L/R

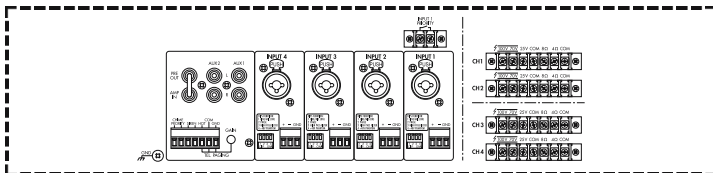

**PA-8120RCD**

Order No. 17.3040



**Mono PA mixing amplifier,** with integrated CD player and radio.

- 1 x 120W<sub>RMS</sub>
- CD player with drawer mechanism, repeat function and random play, reproduction of audio CD/CD-R/CD-RW, USB interface, separate on/off switch
- AM/FM radio module with 5 programmable station buttons, scan buttons, volume control and separate on/off switch

- 4 mic/line inputs, to be configured via DIP switches (mic/line, phase, high-pass filter, 48V phantom power)
- 2 aux inputs, to be configured via DIP switches (aux1/aux2, 10dB attenuation, high-pass filter)
- Siren function and chime function
- Priority circuit
- Speaker outputs via screw terminals
- Line output
- Insert facility for preamplifier
- Input and output level controls
- 2-way tone control for the output
- 482mm (19") rack installation

Model	PA-8120RCD
Output power	120W <sub>RMS</sub>
Mic input	1.8mV
Aux input	300mV
Phono input	-
Speaker output	4/8/16Ω, 70/100V
Frequency range	50-16,500Hz, ±3dB
Equalizer bass	±10dB/100Hz
Equalizer midrange	-
Equalizer treble	±10dB/10kHz
S/N ratio	> 65dB
THD	0.5% (1W)
Power supply	230V~/50Hz/365VA
Admiss. ambient temp.	0-40 °C
Dimensions	483x110x450mm, 2RS
Weight	10.5kg
Special feature	USB
<b>Inputs</b>	
Microphone/line	4 x XLR/6.3mm (combo)
	4 x screw plug-in terminal
Aux	2 x RCA L/R (aux 1/2)
	2 x screw plug-in terminal

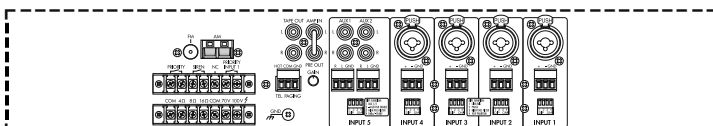

## PA-890CD

Order No. 17.3030



**Mono PA mixing amplifier,**  
with integrated CD player and radio.

- 1 x 80W<sub>RMS</sub>
- CD player with drawer mechanism, repeat function and random play, reproduction of audio CD/CD-R/CD-RW, USB interface, separate on/off switch
- AM/FM radio module with 5 programmable station buttons, scan buttons, separate on/off switch
- 3 mic inputs, 1 of which can be switched mic/line
- Siren function
- Speaker outputs via screw terminals
- Input level control
- 2-way tone control for the output
- Mains operation or 24V emergency power operation

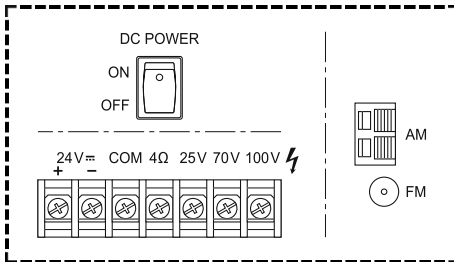

Model	PA-890CD
Output power	80W <sub>RMS</sub>
Mic input	1.5mV
Aux input	300mV
Phono input	-
Speaker output	4Ω, 70/100V
Frequency range	50-15,000Hz, ±3dB
Equalizer bass	±10dB/100Hz
Equalizer midrange	-
Equalizer treble	±10dB/10kHz
S/N ratio	> 52dB
THD	1%
Power supply	230V~/50Hz/265VA
Admiss. ambient temp.	0-40 °C
Dimensions	400x340x110mm, 2RS
Weight	9,5kg
Special feature	USB
<b>Inputs</b>	
Microphone	3 x 6.3mm jack
Line	1 x 6.3mm jack



## PA-802CD

Order No. 17.3020



**Mono PA mixing amplifier,**  
with integrated CD player.

- 1 x 15W<sub>RMS</sub>
- CD player with drawer mechanism, LCD, repeat function and random play, reproduction of audio CD/CD-R/CD-RW, USB interface
- 2 mic inputs
- Mic 1 with automatic talkover
- 1 aux input
- Speaker outputs via screw terminals
- Siren function and chime function
- Level control for each input and CD player
- Mains operation or 12V emergency power operation

Model	PA-802CD
Output power	15W <sub>RMS</sub>
Mic input	5,6mV
Aux input	80mV
Phono input	-
Speaker output	4Ω, 70/100V
Frequency range	100-20Hz, ±3dB
Equalizer bass	-
Equalizer midrange	-
Equalizer treble	-
S/N ratio	> 80dB
THD	< 1%
Power supply	230V~/50Hz/80VA, 12V~/5A
Admiss. ambient temp.	0-40 °C
Dimensions	282x100x300mm
Weight	5,6kg
Special feature	USB
<b>Inputs</b>	
Microphone	2 x 6.3mm jack
Line	1 x 6.3mm jack



**PA-702**

Order No. 17.1330



**Mono PA mixing amplifier**

- 1 x 35W<sub>RMS</sub>
- 2 low-impedance microphone inputs
- 1 aux input, 1 phono input, switchable
- Speaker outputs via spring-loaded terminals
- Input and output level controls
- 3-way equalizer for the output
- Connection for a microphone talk button to switch off the other sources during announcements
- Mains operation



**PA-402**

Order No. 17.1320



**Mono PA mixing amplifier**

- 1 x 20W<sub>RMS</sub>
- 2 low-impedance microphone inputs, front input jacks
- 1 aux input, 1 phono input, switchable
- Speaker outputs via spring-loaded terminals
- Input and output level controls
- Tone control for the output
- Mains operation or 12V battery operation



Model	PA-702	PA-402
Output power	35W <sub>RMS</sub> , 70W <sub>MAX</sub>	20W <sub>RMS</sub> , 40W <sub>MAX</sub>
Mic input	2mV	3mV
Aux input	150mV	150mV
Phono input	3mV	3mV
Speaker output	4/8Ω, 100V	4/8Ω, 100V
Frequency range	65-16,000Hz, ±3dB	100-15,000Hz, ±3dB
Equalizer bass	±10dB/150Hz	-
Equalizer midrange	±10dB/1kHz	-
Equalizer treble	±10dB/6kHz	±10dB/10kHz
S/N ratio	> 55dB	> 55dB
THD	< 2%	< 2%
Power supply	230V~/50Hz/92VA	230V~/50Hz/47VA 12V~/2.5A
Admiss. ambient temp.	0-40 °C	0-40 °C
Dimensions	320x85x230mm	320x85x230mm
Weight	4.5kg	3.8kg
<b>Inputs</b>		
Microphone	2 x 6.3mm jack	2 x 6.3mm jack
Aux, phono	1 x RCA L/R each	1 x RCA each

**PA-888**

Order No. 17.0430



**Mono PA mixing amplifier**

- 1 x 45W<sub>RMS</sub>
- 2 microphone inputs, 1 aux input
- Chime, siren and fog horn, adjustable level
- Tone control
- 7-step LED level display
- Protective circuit with protection LED display
- Mains operation or 12V battery operation

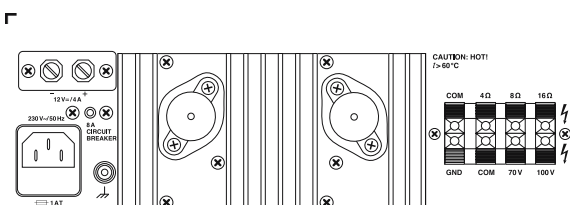

Model	PA-888
Output power	45W <sub>RMS</sub> , 100W <sub>MAX</sub>
Mic input	2.8mV/10kΩ
Aux input	40mV/47kΩ
Speaker output	4/8/16Ω, 70/100V
Frequency range	40-20,000Hz
Tone control	-15dB/5kHz
S/N ratio	> 55dB
THD	< 2%
Power supply	230V~/50Hz/150VA or 12V~/4A
Admiss. ambient temp.	0-40 °C
Dimensions	280x100x280mm
Weight	6.38kg
<b>Inputs</b>	
Mic	2 x 6.3mm jack
Aux	6.3mm jack
Outputs, speakers	spring-loaded terminals
<b>Power supply</b>	
230V~	3-pin IEC jack
12V~	screw terminals

### PA-100

Order No. 17.0040

**Mono PA mixing amplifier, 10W<sub>MAX</sub>.**

- 1 microphone input, 1 aux input
- Supplied with hand-held microphone
- Siren
- 12V battery operation



### PA-302

Order No. 17.1270

**Mono PA mixing amplifier, 20W<sub>MAX</sub>.**

- 1 microphone input, 1 aux input
- 2 speaker outputs, switchable
- Built-in speaker
- Can also be operated as an intercom system
- Siren and fog horn, automatic fog horn
- Supplied with hand-held microphone
- 12/24V battery operation, automatic switching



### PAM-10

Order No. 17.0150

**PA amplifier, with zone paging microphone.**

- Integrated amplifier 10W<sub>RMS</sub>
- Talk button and volume control, speaker connection 4-16Ω
- Power supply: 230V~/50Hz/12VA
- Dimensions: 167x65x130mm
- Mains operation



Model	PA-100	PA-302
Output power	6.5W <sub>RMS</sub> , 10W <sub>MAX</sub>	14W <sub>RMS</sub> , 20W <sub>MAX</sub>
Mic input	2mV	3mV
Aux input	100mV	50mV
Output	4+8Ω	4-16Ω
Frequency range	130-24,000Hz	20-20,000Hz
S/N ratio	65dB	65dB
THD	< 3%	< 0.5%
Power supply	12V~/2A	12-15V~/2A, 24V~/1A
Admiss. ambient temp.	0-40 °C	0-40 °C
Dimensions	150x40x145mm	175x60x170mm
Weight	1.2kg	1.5kg
<b>Inputs</b>		
Mic	1 x 5-pole DIN jack	1 x 6.3mm jack
Aux	1 x 5-pole DIN jack	1 x RCA
<b>Outputs</b>		
Speakers	1 x 5-pole jack	2 x 2-pole screw plug-in terminal
Ext. speaker	-	1 x 3-pole screw plug-in terminal with jumper
<b>Power supply</b>	1 x 5-pole jack	1 x 2-pole screw plug-in terminal

**PA-4040MPX** 482mm  
19" **NEW.**

Order No. 17.3450

**4-zone mixer**, for general multiroom PA applications.

- 4 zones with routing facility of all input channels as desired
- 3 inputs microphone/line via comb. jacks
- 2 inputs line stereo via RCA jacks
- Each input channel with gain control, 2-way tone control and zone routing switch
- Microphone inputs with +15V phantom power, to be switched on as required
- Priority function for channels 1-3, switchable
- Independent paging input, can be routed to each zone
- 4 zone outputs, can be adjusted individually
- Connection for monitor speaker
- Level control via zone VU meter and monitor VU meter



- Adjustable headphone output
- Mains operation or 24V emergency power operation

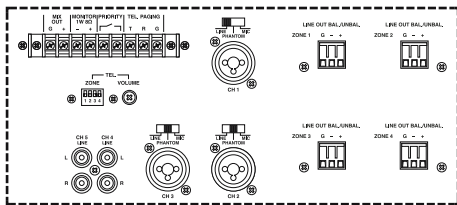

Model	PA-4040MPX
<b>Inputs</b>	
Mic/line 1-3	5mV/4kΩ, 100mV/10kΩ
Line 4-5	100mV/30kΩ
Telephone paging	40mV/5kΩ
<b>Outputs</b>	
Line (zone)	1.7V, bal.
Line (mix out)	3.95V
Monitor speakers	8Ω/1W
Frequency range	50-17,000Hz
<b>Tone control</b>	
Bass	±10dB/100Hz
Treble	±10dB/10kHz
<b>S/N ratio</b>	
Mic	> 65dB
Line	> 75dB
THD	< 1%
Admiss. ambient temp.	0-40 °C
Power supply	230V~/50Hz/20VA, 24V~/600mA
Dimensions	482x133x220mm, 3RS
Weight	4.5kg

**MPX-4PA** 482mm  
19"

Order No. 20.2070

**3-zone mixer**

- 3 zones with routing facility of all input channels as desired
- XLR and RCA zone outputs
- 6 input channels (4 stereo ways, 2 microphone ways)
- Both microphone ways can only be routed together
- Recessed gain control for each input channel
- Microphone ways, each with 2-way tone control, talkover and PAD switch
- Switchable stereo channels: 2 x phono/line and 2 x line/line
- Zone outputs, each with 3-way equalizer, LED level display of the stereo master, balance control, pre-fader listening (PFL) and mono/stereo selector switch



- Adjustable headphone output with pre-fader listening (PFL) to the stereo input channels and the zone outputs
- Connection for gooseneck light GNL-200, GNL-204 or GNL-205

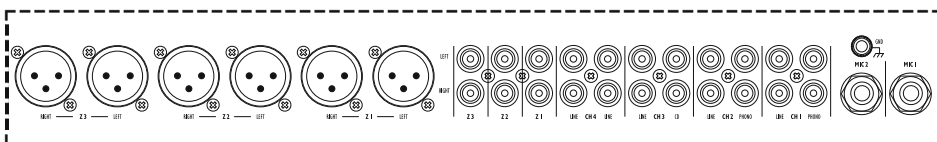

Model	MPX-4PA
Mic input	1.5mV
Phono input	3mV
CD input	150mV
Line input	150mV
Master output	1V/600Ω
Record output	-
Headphones	≥ 8Ω
Frequency range	20-20,000Hz
THD	0.1%
S/N ratio	61dB, unweighted
Equalizer, bass	+12dB, -12dB/50Hz
Equalizer, midrange	+12dB, -12dB/1kHz
Equalizer, treble	+12dB, -12dB/10kHz
Talkover	-16dB
Gooseneck light	12V/5W, BNC
Power supply	230V~/50Hz/20VA
Admiss. ambient temp.	0-40 °C
Dimensions	482x177x105mm, 4RS
Weight	3.75kg



## MPX-52PA

Order No. 20.2300



- 2-zone mixer, for multiroom PA applications.
- 2 independent zones with routing facility of all input channels as desired
- 1 microphone way as announcing channel, balanced, with 3-way equalizer and adjustable automatic talkover
- 4 stereo input channels with stereo line inputs and balanced microphone ways
- Channel 1 additionally with a balanced line input, channels 3 and 4 switchable line/phono
- Signal/peak indication for each channel
- Recessed gain control for each input channel
- Zone outputs, balanced, with 3-way equalizer, LED level indication of the stereo master, balance controls, pre-fader listening (PFL) and mono/stereo selection

- Adjustable headphone output with pre-fader listening (PFL) to the stereo input channels and the zone outputs
- 2 zone outputs for each stereo RCA and XLR L/R, bal.
- 1 record output for each zone (independent of talkover and announcements)
- Connection for gooseneck light GNL-200, GNL-204 or GNL-205

Model	MPX-52PA
Mic input	1.5mV
Phono input	3mV
CD input	-
Line input	120mV
Master output	1V
Record output	550mV
Headphones	≥ 32Ω, stereo
Frequency range	20-20,000Hz
THD	< 0.1%
S/N ratio	71dB, unweighted
Equalizer, bass	±15dB/50Hz
Equalizer, midrange	±12dB/1kHz
Equalizer, treble	±15dB/10kHz
Talkover	level attenuation 20dB max.
Gooseneck light	12V/5W, BNC
Power supply	230V~50Hz/15VA
Admiss. ambient temp.	0-40 °C
Dimensions	482x138x190mm, 3RS
Weight	4.3kg

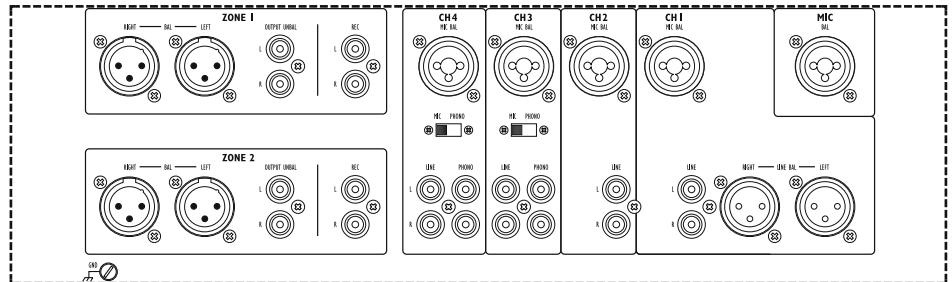

## PA-1412MX

Order No. 17.3440



### 10-channel PA preamplifier

- 5 XLR input channels, switchable mic/line
- 4 input channels, switchable XLR mic/RCA line
- 2 XLR master outputs
- 1 record output (master 1, master 2)
- Input channels with level control and output selector switch (master 1, master 1+2, master 2)
- Each master output with 2-way tone control
- Chime button with priority circuit, remote control possible, 2-tone chime or 4-tone chime, siren (selectable)

- 1 push-to-talk connection, RJ45, with priority circuit (suitable e.g. for PA-4000PTT)
- Low cut filter to be switched on additionally for each microphone input
- Priority circuit for channels 2-3
- Phantom power for electret microphones can be switched on additionally for each XLR input channel
- Mains operation or 24V emergency power operation

Model	PA-1412MX
Frequency range	20-20,000Hz (-0.5dB)
Input sensitivity	
Mic	2.5mV, bal.
Line XLR	250mV, bal.
Line RCA	250mV, unbal.
Outputs	1.2V/200Ω, bal.
S/N ratio	
Mic	> 60dB
Line	> 75dB
THD	< 0.05%
Admiss. ambient temp.	0-40 °C
Power supply	230V~50Hz/15VA, 24V=0.5A
Dimensions	482x45x240mm, 1RS
Weight	3.9kg

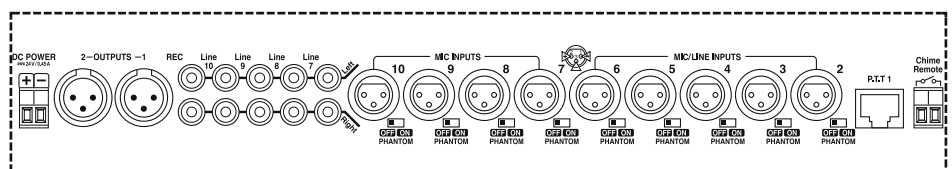



**CD-122**

Order No. 21.2820



Dual CD and MP3 player, with USB 2.0 interface and SD/MMC card slot.

- USB storage media can be connected directly
- For SD/MMC cards up to 32GB (FAT16/FAT32), available at option
- Anti-shock system
- Supports ID3 tags
- Supports WMA
- Folder navigation
- Autoplay function
- Fast forward and reverse

- Track programming
- Repeat function (repeat 1, repeat all)
- Random play
- Supplied with infrared remote control
- 482mm (19") rack installation, 1RS
- Audio CD/CD-R/CD-RW/MP3 CD



**CD-112TRS**

Order No. 21.2810



CD and MP3 player, with USB 2.0 interface, RS-232 interface, SD/MMC card slot and FM/AM tuner.

- USB storage media can be connected directly
- For SD/MMC cards up to 32GB (FAT16/FAT32), available at option
- Tuner with 100 memory places (60 x FM, 40 x AM)
- Anti-shock system
- Supports ID3 tags
- Supports WMA
- Folder navigation
- Autoplay function

- Fast forward and reverse
- Track programming
- Repeat function (repeat 1, repeat all, repeat folder)
- Random play
- Balanced XLR outputs for tuner and CD
- RS-232 interface for remote control
- Supplied with infrared remote control and antennas for FM/AM reception
- 482mm (19") rack installation, 1RS
- Audio CD/CD-R/CD-RW/MP3 CD



Model	CD-122	CD-112TRS
<b>General information</b>		
Frequency range	20-20,000Hz	20-20,000Hz
THD	< 0.1%	< 0.1%
Channel separation	> 60dB	> 60dB
Dynamic range	> 96dB	> 96dB
S/N ratio	> 70dB	> 70dB
Wow and flutter	not measurable, quartz precision	not measurable, quartz precision
Output, analog	1.2V	1.2V
Output, digital	-	-
Power supply	230V~/50Hz/50VA	230V~/50Hz/50VA
Admiss. ambient temp.	0-40 °C	0-40 °C
Dimensions, player mech.	482x44x265mm, 1RS	482x44x265mm, 1RS
Dimensions, control panel	-	-
Weight	4.3kg	4.1kg
<b>Connections</b>		
Analog output	2 x RCA L/R	1 x XLR L/R, bal. (CD) 1 x XLR L/R, bal. (tuner)



### CD-112

Order No. 21.2800



**CD and MP3 player**, with USB interface and SD/MMC card slot.

- USB storage media can be connected directly
- For SD/MMC cards up to 32GB (FAT16/FAT32), available at option
- Anti-shock system
- Supports ID3 tags
- Autoplay function
- Fast forward and reverse
- Track programming

- Folder navigation
- Repeat function (repeat 1, repeat all, random repeat)
- Random play
- Supplied with infrared remote control
- 482mm (19") rack installation, 1RS
- Audio CD/CD-R/CD-RW/MP3 CD



### DPR-110

Order No. 21.2320



**MP3 recorder**, with USB interface and SD/MMC card slot.

- USB storage media can be connected directly (e.g. USB flash drive)
- For SD/MMC cards up to 8GB (FAT16/FAT32), available at option
- Recording from USB medium, SD/MMC card or external source (aux) onto USB medium or SD/MMC card
- Selectable recording bit rate: 96/128/192kbps
- Supports MP3 and WMA
- Supports ID3 tags
- Fast forward and reverse

- Track programming
- Folder navigation
- Repeat function (repeat 1, repeat all, repeat album)
- Random play
- Intro play
- Supplied with infrared remote control
- 482mm (19") rack installation with supplied mounting brackets, 1RS



Model	CD-112	DPR-110
<b>General information</b>		
Frequency range	20-20,000Hz	20-20,000Hz
THD	< 0.1%	< 0.3%
Channel separation	> 60dB	> 60dB
Dynamic range	> 96dB	> 96dB
S/N ratio	> 70dB	> 60dB
Wow and flutter	not measurable, quartz precision	-
Output, analog	1.2V	1.2V
Output, digital	-	-
Power supply	230V~/50Hz/50VA	230V~/50Hz/50VA
Admiss. ambient temp.	0-40 °C	0-40 °C
Dimensions, player mech.	482x44x265mm, 1RS	430x44x265mm, 1RS (w/o mounting brackets)
Weight	4kg	3.4kg
<b>Connections</b>		
Analog output	1 x RCA L/R	1 x RCA L/R (aux input) 1 x RCA L/R



**CD-156**

Order No. 21.2410



**Stereo CD and MP3 player**, with USB 2.0 interface, for HiFi and PA applications.

- USB storage media can be connected directly (e.g. USB hard disk, USB flash drive)
- Anti-shock system
- Supports WMA
- Repeat function (repeat 1, repeat all), random play, standard operating functions
- Adjustable headphone output
- Supplied with infrared remote control with direct track selection
- 482mm (19") rack installation with supplied mounting brackets, 2RS
- Audio CD/CD-R/MP3 CD



**PDD-2620**

Order No. 21.2470



**5-way CD changer**, with MP3 support and optical digital output.

- Compatible with CD-R/RW/MP3
- Supports ID3 tags
- Track programming
- Folder navigation
- Repeat function (repeat 1, repeat all)
- Random play
- Adjustable headphone output
- Supplied with infrared remote control
- Power supply: 230V~/50Hz/20VA
- Dimensions: 435x115x390mm
- Weight: 6.2kg



**CDP-1260**

Order No. 21.2460



**CD and MP3 player**

- Compatible with CD-R/RW/MP3
- Fast forward and reverse
- Track programming
- Folder navigation
- Repeat function (repeat 1, repeat all, repeat album)
- Random play
- Adjustable headphone output
- Supplied with infrared remote control
- Power supply: 230V~/50Hz/15VA
- Dimensions: 435x100x285mm
- Weight: 4.1kg

### TR-650

Order No. 21.2710

**TEAC**

#### RDS stereo tuner

- 2-band tuner (FM/AM)
- RDS text (PS/PTY/RT/TA/CT)
- 50 programmes can be stored (30 FM, 20 AM)
- Dimmable display
- Digital display of signal strength
- Automatic station scanning
- Timer function and sleep function
- Antenna connection: 75Ω



- Power supply: 230V~/50Hz/10VA
- Dimensions: 435x87x294mm
- Weight: 2.9kg



### ADRW-900

Order No. 21.2920



**TEAC**

#### CD and MP3 recorder, with USB interface and integrated tape deck.

For direct dubbing from audio cassettes, CDs or via the analog audio input onto external USB storage media in MP3 format.

#### CD recorder/player:

- Random play
- Repeat function (repeat 1, repeat all, programme, A-B)
- Shuffle
- Intro play
- New track number (automatic/manual)

#### Tape deck:

- Auto reverse (rec./play)
- Pitch control
- Dolby B noise suppression
- Timer recording, timer play
- Manual level control with visual indicator

#### Reproduction:

- Audio CD, CD-R/RW and MP3 CD
- Compact cassettes
- USB storage media (MP3)

#### Recording options:

- CD to tape and USB

- Tape to CD and USB
- Line in (aux) to tape, CD and USB
- Digital in to tape, CD and USB
- USB output for connecting CD, tape, digital input and aux directly to a PC

#### General information:

- Analog audio input and output
- Digital audio input
- Adjustable headphone output
- Infrared remote control
- Power supply: 230V~/50Hz
- Dimensions: 435x145x288mm
- Weight: 5.3kg



### AG-790A

Order No. 21.2450

**TEAC NEW.**

#### Stereo receiver

- 2 x 100W<sub>RMS</sub> (8Ω)
- 4 audio inputs
- 2-way tone control
- A/B speaker selection
- 2-band tuner (FM/AM)

- RDS text (PS/PTY/RT/TA/CT)
- 30 programmes can be stored
- Automatic station scanning
- Timer function and sleep function
- Antenna connection: 75Ω
- Headphone connection

- Supplied with infrared remote control
- Power supply: 230V~/50Hz/420VA
- Dimensions: 435x139x335mm
- Weight: 9.4kg



**DPR-10**

Order No. 17.2740



**Compact MP3 recorder**, with USB interface and SD/MMC card slot.

- USB storage media can be connected directly (e.g. USB flash drive)
- For SD/MMC cards up to 8GB (FAT16/FAT32), available at option
- Recording from USB medium, SD/MMC card or external source (aux) onto USB medium or SD/MMC card
- Selectable recording bit rate: 96/128/192kbps
- Supports MP3 and WMA
- Supports ID3 tags
- Fast forward and reverse
- Track programming
- Folder navigation
- Repeat function (repeat 1, repeat all, repeat album)
- Random play
- Intro play
- Supplied with infrared remote control
- 12V power supply via plug-in PSU, available at option



Model	DPR-10
<b>General information</b>	
Frequency range	20-20,000Hz
THD	< 0.3%
Channel separation	> 60dB
Dynamic range	> 96dB
S/N ratio	> 60dB
Output, analog	1.2V
Power supply	via optional PSU, e.g. PSS-600E
Admiss. ambient temp.	0-40 °C
Dimensions, player mech.	175x52x110mm
Weight	545g
<b>Connections</b>	
Analog output	1 x RCA L/R (aux input)

**SD-32CARD**

Order No. 18.2650



**SDHC memory card, 32GB**

- For units with SDHC card slot
- Class 10, preformatted FAT32

**SD-16CARD**

Order No. 18.2640



**SDHC memory card, 16GB**

- For units with SDHC card slot
- Class 10, preformatted FAT32

**SD-8CARD**

Order No. 18.2360



**SDHC memory card, 8GB**

- For units with SDHC card slot
- Class 10, preformatted FAT32

**SD-4CARD**

Order No. 18.2350



**SDHC memory card, 4GB**

- For units with SDHC card slot
- Class 10, preformatted FAT32

**SD-2CARD**

Order No. 18.2340



**SD memory card, 2GB**

- For units with SD card slots
- Class 10, preformatted FAT16

**SD-4MICRO**

Order No. 18.2750

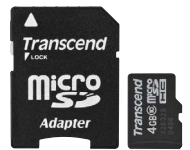

**Micro SDHC memory card, 4GB**

- For units with micro SDHC card slot
- Class 10, preformatted FAT32
- Supplied with size adapter

Although SDHC cards have got the same format as customary SD cards, they feature a different internal setup and can only be used in units capable of SDHC.

**USB Flash Drives "KINGSTON DataTraveler 102"**

For storing and transporting data when using units with a USB interface, e.g. PCs, media players and digital recorders.

- High-speed USB 2.0
- Operating temperature: 0-60°

Model	Order No.	Capacitance	Data rate	Colour
USB-4GB	18.7210	4GB	10Mbps	yellow
USB-8GB	18.7220	8GB	10Mbps	blue
USB-16GB	18.7200	16GB	10Mbps	white



## Multizone PA Application

An example of PA application in restaurants and bars.

Sports bars have become more and more popular. Mainly, in separate areas, sports events are shown on large screens. In most cases, these events are received via TV.

The following example does not only show a PA application in this area, but a restaurant and bar area and an outside area are also added.

Although, a PA application of the individual areas at different volume levels is possible with standard PA systems, attenuators in the speaker cables will then have to be used. However, different programmes are not possible.

Even though, individual amplifiers are available for the individual areas, each of the mixers only features one output.

This can now be changed by using a multizone mixer. For this purpose, the multizone mixer MPX-4PA features 3 equal zone outputs, each with a master control and tone control.

The routing switches under each input channel are actually the special feature. This allows to choose as desired which input is assigned to which output zone. Only these allow to run an individual programme in each zone. Thus, the different programmes can be distributed to the zones within seconds. In the sports area, for example, a football match can be shown, quiet background music can be listened to in the restaurant/bar area and a speech can be held in the outside area via a microphone. At a touch of a button, the individual areas can be combined without delay.

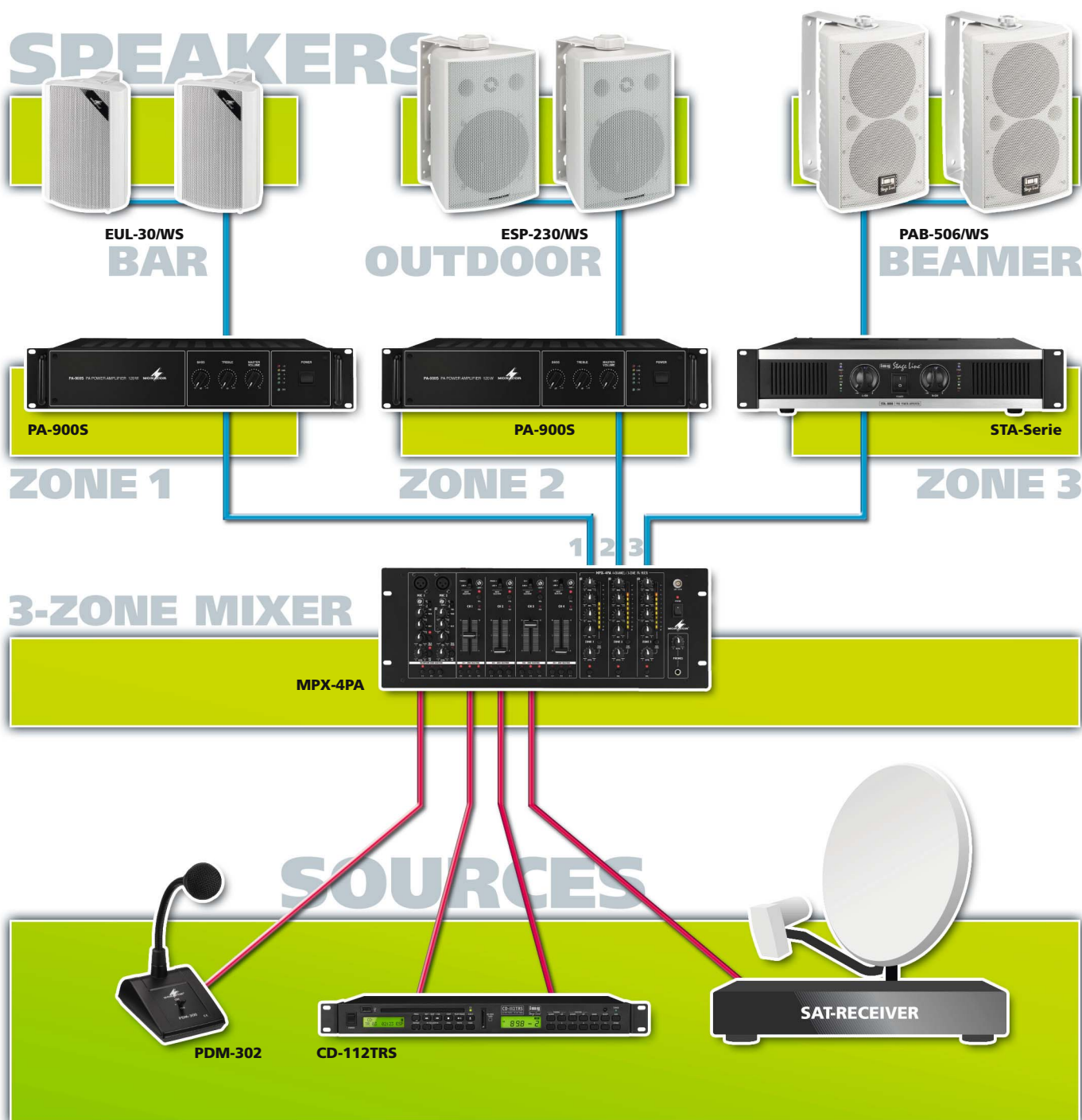

### ... for the 100 V to Line Converter PATL-100

With the **PATL-100** (see page E 158), a 100 V signal can be converted into a line signal. In this case, both signals are galvanically isolated from each other.

#### Example 1:

With the mixing amplifier **PA-1240**, 5 speaker circuits of 80 W each are to be operated. The total power of the amplifier alone is not sufficient for this.

In the example, the zones 1 to 3 are directly operated from the mixing amplifier **PA-1240**. One **PATL-100** each is connected to the zone outputs 4 + 5 and thus the 100 V signal is converted into a line signal. With this line signal, further power amplifiers can be controlled which supply on their part the speakers of the zones 4 + 5. The full functionality of the zone control of the **PA-1240** amplifier is maintained, e.g. by the system microphone **PA-1120RC**.

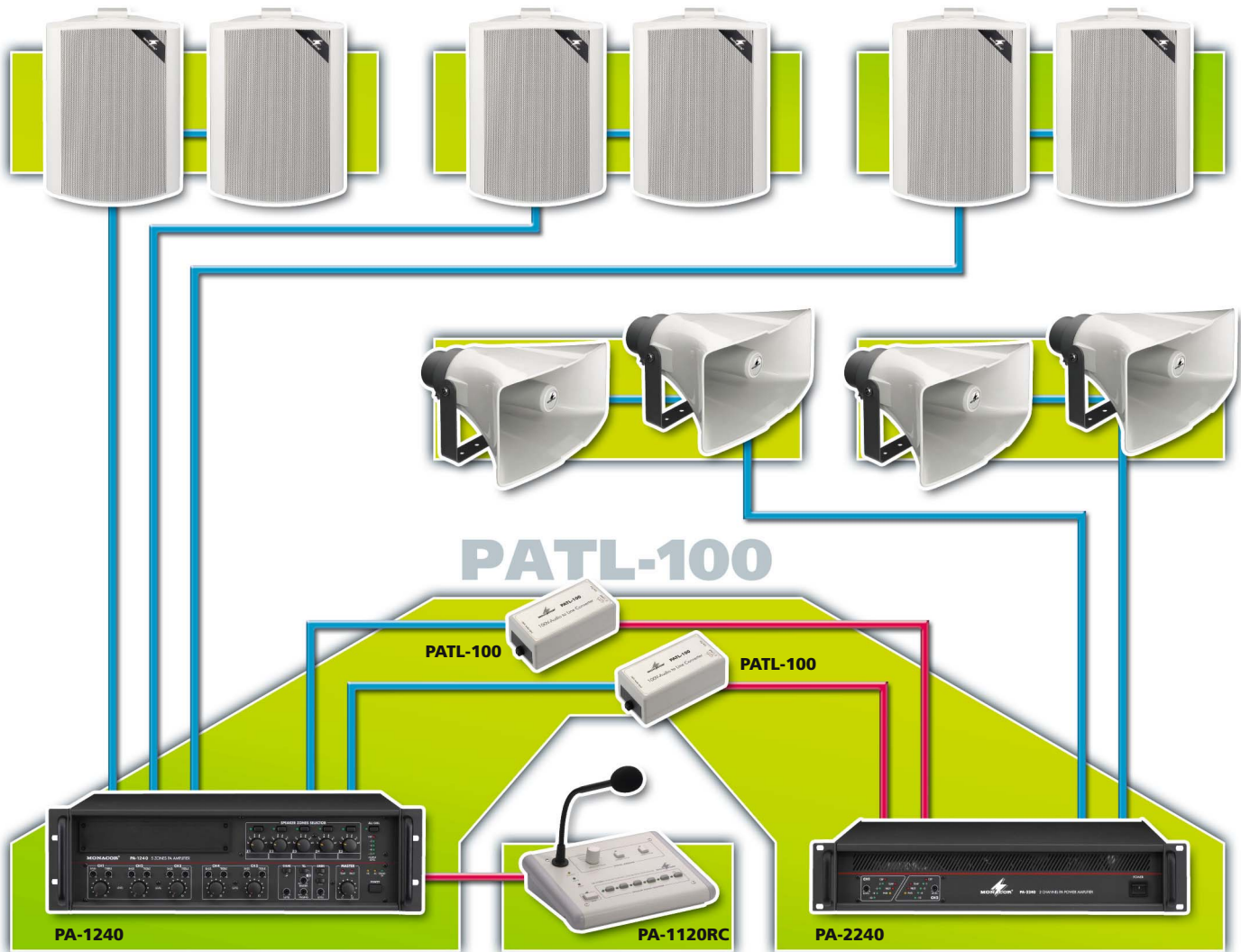

#### Example 2:

A further amplifier is to be added to an existing system. This amplifier is located in another part of the building.

With the **PATL-100**, the signal can very easily be picked up from the existing 100 V line for feeding it to the new amplifier.

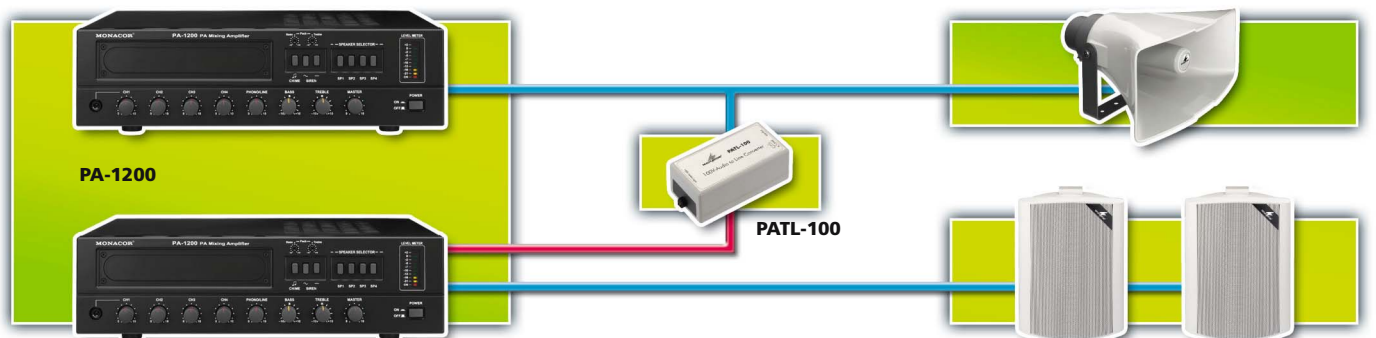

### ICM-20

Order No. 17.3110

**Intercom system**, cable-connected, consisting of a desktop microphone and separate call station. Ideally suited e.g. for reception desks and sales desks.

Desktop microphone:

- 300mm gooseneck, removable (XLR connection)
- Electret microphone cartridge, cardioid characteristic
- Built-in amplifier and speaker
- Volume control
- Push-to-talk button
- Power supply 9V $\approx$ /300mA via supplied PSU
- Dimensions console housing: 115x65x170mm

Call station:

- Built-in speaker and microphone
- Call button (buzzer)
- 3m connection cable for connecting to a desktop microphone
- Supplied with mounting accessories for the attachment to glass panels
- Power supply via desktop microphone
- Dimensions:  $\varnothing$  85mm x 35mm



### Sound from the Socket

**Description of features:**

A microphone with a 6.3mm plug and a sound source, e.g. CD player, tuner, etc. with RCA plugs can be connected to the preamplifier PREAMP-1UP and be adjusted separately via the two front controls.

The preamplifier PREAMP-1UP is connected to the power amplifier AMP-1UP. The cabling can be realised via the main lead, i.e. the signals can be fed through from one unit to the other.

A max. of 20 power amplifiers AMP-1UP can be connected to one

preamplifier PREAMP-1UP. The speakers must be connected to the power amplifier AMP-1UP. Two 8 $\Omega$  speakers or one 4 $\Omega$  speaker can be operated with one power amplifier.

- Designed for transmitting announcements and music conveniently to different rooms
- Individual volume control and switching-off possible in each room
- Compatible with many ranges of standard switches
- Suitable for standard 63mm flush-mount wall sockets



### AMP-1UP

Order No. 17.1340

**Flush-mount power amplifier, 10W**

- For the connection to one preamplifier PREAMP-1UP
- Fitted metal base plate
- Incl. level scale and volume sticker



### PREAMP-1UP

Order No. 17.1350

**Flush-mount preamplifier**

- For the connection of up to 20 power amplifiers AMP-1UP
- Fitted metal base plate
- Connections and level controls for line input and microphone input

Model	AMP-1UP	PREAMP-1UP
Frequency range	45-20,000Hz	20-20,000Hz (line) 40-15,000Hz (mic)
Input	5V max./47k $\Omega$	400mV (line) 4mV (mic)
Output	10W at a load of 4 $\Omega$	5V max./50 $\Omega$
Control voltage	0-10V $\approx$	0-10V $\approx$
Power supply	22-26V $\approx$ /0.77A	22-26V $\approx$ /0.025A
Connection	7-pole terminal strip, removable	7-pole terminal strip, removable 1 x RCA L/R (line) 1 x 6.3mm jack (mic)

## LA-200

Order No. 17.2110



**Active loop amplifier**, in constant current technology with dynamic compressor for setting up an inductive sound reproduction system.

The inductive transmission of audio signals allows users of hearing aids with a T-coil or inductive receivers, e.g. the LR-200, to receive audio signals. The wireless transmission is an advantage of inductive sound reproduction systems which makes it possible for the user to move freely within the loop.

Inductive sound reproduction systems are used for various applications, e.g. as a hearing aid for the hearing impaired in churches, theatres, cinemas, waiting rooms and lounges, as interpreting systems, for lectures in museums, exhibitions, etc.

With inductive sound reproduction systems, an inductive loop made of a wire winding is laid on the floor, the wall or along the ceiling



and is controlled by a constant current amplifier. Thus, a magnetic field is created within the loop which induces a voltage into the T-coil of the hearing aid or into the inductive receiver. In the receivers, this voltage is then converted again into an audio signal.

- Dynamic compressor
- Automatic talkover
- Metal loss correction 0-(+3)dB/oct.
- Phantom power can be switched on additionally
- 482mm (19") rack installation with supplied mounting brackets

Model	LA-200
Loop current	7A <sub>PEAK</sub>
Loop resistance	0.2-2Ω
Room size	up to 200m <sup>2</sup>
Inputs	Mic/line mic 1.6mV/2.6kΩ, combo, bal. switchable to line 630mV/6.5kΩ, combo, bal. line 630mV/9kΩ, RCA, unbal. alarm: 2 screw terminals for connecting a switch
Equalizer	Bass ±8dB, 100Hz Treble ±10dB, 10kHz
Frequency range	50-7,500Hz, ±3dB
THD	0.1%
Admiss. ambient temp.	0-40 °C
Power supply	230V~/50Hz/150VA
Dimensions	482x88x280mm, 2RS
Weight	8kg

## LR-200

Order No. 17.2120

**Inductive receiver**, for receiving audio signals in inductive sound reproduction systems. The electromagnetic field which is created by an induction loop is received by the inductive receiver and converted into an audio signal. Any number of receivers can be operated within one induction loop.

The unit is suitable for people with and without hearing problems and can be used for various applications:

- Hearing aid for the hearing impaired
- Operational test of inductive sound reproduction systems
- Detection of stray radiation within a loop
- Interpreting systems
- Lectures in museums, exhibitions, etc.

- 3.5mm mono connection for headphones  $\geq 32\Omega$
- Volume control
- Low cut switch
- Belt clip
- Power supply via 9V battery
- Dimensions: 63x100x29mm
- Weight: 100g



## NL-90

Order No. 17.3090

**Induction loop**, for wireless transmission of audio signals to hearing aids via optional pocket transmitter.

- Comfortable to wear around the neck (loop diameter approx. 26cm)
- Matching the pocket transmitters ATS-10R, ATS-16R, ATS-40R, TXA-800R
- 3.5mm stereo jack connection

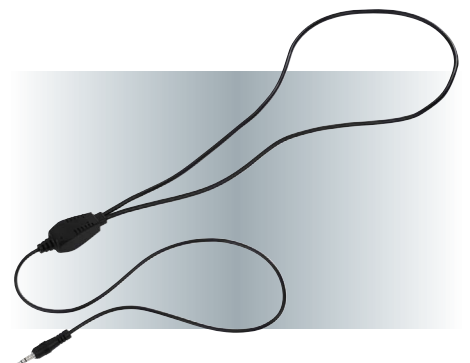

### LA-40

Order No. 17.2330

**Active loop amplifier**, with dynamic compressor, specifically for setting up an inductive sound reproduction system in domestic locations.

The loop amplifier LA-40 transmits the audio signals from a TV, audio system and/or microphone to the induction loop which is laid on the floor, the wall or along the ceiling. Thus, a magnetic field is created within the loop which is received by the T-coil of the hearing aid or the inductive receiver and is then converted again into an audio signal.

The wireless transmission is an advantage of inductive sound reproduction systems. It makes it possible for the user to move freely within the loop and to adjust the volume of the hearing aid or receiving unit (LR-200) as desired, without disturbing the other occupants.

The LA-40 can be connected directly to the SCART jack of a TV (via supplied SCART adapter) or to an audio system. Talks of the other occupants can be heard via the connection of a microphone which is available at option.

The integrated signal generator of the LA-40 allows to create an alarm signal via an optional switch.

- Supplied with 35m loop wire for setting up an induction loop, SCART adapter, PSU
- Integrated alarm signal can be switched on additionally
- Dynamic compressor
- Adjustable input sensitivity for line and microphone
- 2-way tone control
- Adjustable loop current
- LEDs for power, signal/PEAK and loop current
- Headphone connection on the front panel
- Built-in phantom power for electret microphones
- Recommended microphone: ECM-300LA



Model	LA-40
Loop current	2.8A <sub>PEAK</sub>
Loop resistance	0.4-2Ω
Room size	up to 40m <sup>2</sup>
Inputs	
Mic/line	mic: 2mV/660Ω (phantom voltage: 7.2V) 6.3mm jack line: 48mV/11kΩ, 2 x RCA alarm: 2 terminals for connecting a switch
Outputs	loop: connection of the supplied loop via 2 terminals headphones: ≥ 32Ω, 3.5mm jack
Equalizer	
Bass	±8dB, 100Hz
Treble	±10dB, 10kHz
Frequency range	75-7,500Hz, ±3dB
THD	0.44%
Admiss. ambient temp.	0-40 °C
Power supply	12V~/1.5A via supplied PSU
Dimensions	175x102x45mm
Weight	510g

### ECM-300LA

Order No. 23.5310

#### Boundary microphone

- The ideal addition to loop amplifier LA-40
- Perfectly integrates voice and ambient noise into the loop system
- 6m connection cable with 6.3mm mono plug

Model	ECM-300LA
System	electret/semicardiod
Frequency range	30-20,000Hz
Impedance	300Ω
Sensitivity	4mV/Pa/1kHz
Max. SPL	120dB
Power supply	9-48V= via LA-40
Admiss. ambient temp.	0-40 °C
Dimensions	ø 43mm x 15mm
Weight	40g
Connection	6.3mm jack, unbal.





**ECM-500**

Order No. 23.2550

- PA desktop microphone, with gooseneck.**
- Electret, cardioid characteristic
  - Indicating light for microphone operation
  - ON/OFF switch
  - Removable gooseneck (XLR connection)
  - Solid version



**ECM-310P**

Order No. 23.2430

- PA desktop microphone, with gooseneck.**
- Electret, cardioid characteristic
  - Phantom power
  - ON/OFF switch
  - 3m connection cable with XLR plug, balanced



**ECM-200**

Order No. 23.0280

- PA desktop microphone, with gooseneck.**
- Electret, omnidirectional characteristic
  - Push-to-talk button and lock button



**PDM-302**

Order No. 23.5560

- PA desktop microphone, with gooseneck.**
- Dynamic, cardioid characteristic
  - Low-noise push-to-talk switch, latching or non-latching
  - 5m connection cable with XLR plug, balanced



**PDM-300**

Order No. 23.1200

- PA desktop microphone, with gooseneck.**
- Dynamic, cardioid characteristic
  - Low-noise push-to-talk switch, latching or non-latching
  - 1m helix cable, balanced, with 6.3mm mono plug



**ECM-450**

Order No. 23.3370

- PA desktop microphone, with gooseneck.**
- Electret, cardioid characteristic
  - Volume control for speech and chime
  - Different types of chimes to be selected
  - Automatic chime activation (can be switched off)
  - Power supply via supplied PSU or batteries (not supplied)
  - 1.5m connection cable with 6.3mm connector (on both ends)

Model	ECM-500	ECM-310P	ECM-200	PDM-302	PDM-300	ECM-450
<b>General information</b>						
Frequency range	100-16,000Hz	80-14,000Hz	60-12,000Hz	60-12,000Hz	60-12,000Hz	100-12,000Hz
Sensitivity	3.9mV/Pa/1kHz	8mV/Pa/1kHz	6mV/Pa/1kHz	3.2mV/Pa/1kHz	3.2mV/Pa/1kHz	3.2mV/Pa/1kHz
Impedance	600Ω	250Ω	1kΩ	600Ω	600Ω	600Ω
S/N ratio	> 40dB	> 55dB	> 40dB	-	-	> 40dB
Admiss. ambient temp.	0-40 °C	0-40 °C	0-40 °C	0-40 °C	0-40 °C	0-40 °C
Power supply	2 x 1.5V batt. AA size	22-48V=, phantom	1 x 1.5V batt. AA size	-	-	3V=/500mA via suppl. PSU or 2 x 1.5V batt. C size
<b>Dimensions</b>						
console housing only	135x60x145mm	ø 80mm x 25mm	75x25x110mm	120x60x160mm	120x60x160mm	180x50x130mm
Total length of gooseneck	450mm	200mm	200mm	310mm	310mm	210mm
Weight	1.5kg	372g	380g	1,100g	1,100g	925g
<b>Connections</b>						
	1 x XLR	XLR, bal.	6.3mm plug	XLR, bal.	6.3mm plug	6.3mm jack low-voltage jack



### ECM-306B/SW

Order No. 23.5790

#### Boundary microphone

- On/off switch with power LED
- Low cut and 10dB attenuation, switchable
- Integrated electronics for the direct connection to a phantom power supply 9-48V $\approx$
- Electronically balanced AF output
- With 6m connection cable and 3-pole mini XLR/XLR plug
- Supplied in a foam-padded plastic case



### ECM-302B

Order No. 23.2370

#### Boundary microphone

- Integrated electronics for the direct connection to phantom power 9-48V $\approx$
- Transformer-balanced AF output
- With 6m connection cable 3-pole mini XLR/XLR



### ECM-304BD

Order No. 23.2510

#### Boundary microphone

- Switchable between cardioid characteristic and omnidirectional characteristic
- Voltage supply via 1.5V button cell (not supplied). Phantom power via mixer not required
- With 4m connection cable and 3.5/6.3mm plug



### ECM-306B/WS

Order No. 23.5800

#### Boundary microphone

- On/off switch with power LED
- Low cut and 10dB attenuation, switchable
- Integrated electronics for the direct connection to a phantom power supply 9-48V $\approx$
- Electronically balanced AF output
- With 6m connection cable and 3-pole mini XLR/XLR plug
- Supplied in a foam-padded plastic case



### ECM-302B/WS

Order No. 23.3630

#### Boundary microphone

- Integrated electronics for the direct connection to phantom power 9-48V $\approx$
- Transformer-balanced AF output
- With 6m connection cable 3-pole mini XLR/XLR



### ECM-304BD/WS

Order No. 23.3270

#### Boundary microphone

- Switchable between cardioid characteristic and omnidirectional characteristic
- Voltage supply via 1.5V button cell (not supplied). Phantom power via mixer not required
- With 4m connection cable and 3.5/6.3mm plug

Model	ECM-306B/SW (.../WS)	ECM-302B (.../WS)	ECM-304BD (.../WS)
System	electret/semi-supercardioid	electret/semicardioid	electret/cardioid/omnidir.
Frequency range	30-20,000Hz	30-20,000Hz	30-20,000Hz
Impedance	250 $\Omega$	250 $\Omega$	600 $\Omega$ /1,000 $\Omega$
Sensitivity	22mV/Pa/1kHz	22mV/Pa/1kHz	7mV/Pa/1kHz
Max. SPL	130dB	140dB	-
Power supply	9-48V $\approx$ , ext. (phantom)	9-48V $\approx$ , ext. (phantom)	1.5V button cell (LR44)
Admiss. ambient temp.	0-40 °C	0-40 °C	0-40 °C
Dimensions	90x16x90mm	$\varnothing$ 120mm x 22mm	70x96x20mm
Weight	200g	350g	300g
Connection	3-pole mini XLR, bal. cable (XLR)	3-pole mini XLR, bal. (cable: XLR)	3.5mm plug

### ECM-10/SW

Order No. 23.2720

### ECM-10/WS

Order No. 23.2730

#### Build-in phantom microphones

- Especially suitable for PA applications
- Metal housing
- Black (SW) or white (WS) cartridge cover



Model	ECM-10/SW (.../WS)
System	electret/omnidirectional
Frequency range	30-17,000Hz
Impedance	300 $\Omega$
Sensitivity	2.3mV/Pa/1kHz
Max. SPL	110dB
Power supply	9-48V $\approx$ , phantom
Body	metal
Dimensions	$\varnothing$ 30mm x 71mm
Weight	90g
Connection, microphone	XLR, bal.





**DM-5000LN**

Order No. 23.0400

**Dynamic microphone**, for stage and vocals. Highly sensitive neodymium magnet version. Supplied with mic. holder, cable and case.



**DM-3200**

Order No. 23.3300

**Dynamic microphone**, for stage, speech and vocals. Supplied with microphone holder, cable and plastic case.



**DM-2500**

Order No. 23.0050

**Dynamic microphone**, for stage, speech, vocals and DJ applications. POP noise head. Supplied with mic. holder, cable and case.

Model	DM-5000LN	DM-3200	DM-2500
System	dyn./supercardioid	dyn./supercardioid	dyn./cardioid
Frequency range	40-18,000Hz	50-16,000Hz	30-18,000Hz
Impedance	250Ω	250Ω	250Ω
Sensitivity	2.5mV/Pa/1kHz	2.5mV/Pa/1kHz	1.5mV/Pa/1kHz
Max. SPL	130dB	145dB	120dB
Body	diecast zinc	metal	diecast zinc
Dimensions	ø 53.5mm x 174mm	ø 55mm x 173mm	ø 54mm x 165mm
Weight	688g	300g	662g
Connection, microphone	XLR, bal.	XLR, bal.	XLR, bal.
Connection, cable	XLR	6.3mm plug	6.3mm plug
Cable	6m, low-noise	5m, low-noise	6m, low-noise



**ECM-285**

Order No. 23.2760

**Electret microphone for the sound pick-up of vocals and instruments**

- Special shock-absorbing cartridge support
- Operation via external phantom power (9-48V=) or internal 1.5V battery
- ON/OFF switch
- Supplied with 6m connection cable XLR/XLR and holder with screw fixing 16mm (5/8")/9mm (3/8")



**ECM-925P**

Order No. 23.1990

**Electret phantom directional microphone**, switchable directional characteristic, from normal to supercardioid with high sensitivity, especially suitable for outdoor recordings, e.g. film productions. Microphone windshield.

Model	ECM-285
System	electret/cardioid
Frequency range	80-15,000Hz
Impedance	400Ω
Sensitivity	5mV/Pa/1kHz
Max. SPL	115dB
Power supply	1 x 1.5V batt. AA size or 9-48V= (phantom)
Admiss. ambient temp.	0-40 °C
Dimensions	ø 26mm x 195mm
Weight	110g
Connection	XLR, bal., cable: 6m

Model	ECM-925P
System	electr./cardioid/supercardioid
Frequency range	80-12,000Hz
Impedance	normal 1kΩ, tele 2.3kΩ
Sensitivity	3/15mV/Pa/1kHz
Max. SPL	120dB
S/N ratio	> 40dB
Power supply	9-48V=, phantom 1.5V battery
Body	metal
Dimensions	ø 25mm x 285mm
Weight	460g
Connection, microphone	XLR
Connection, cable	XLR
Cable	5m

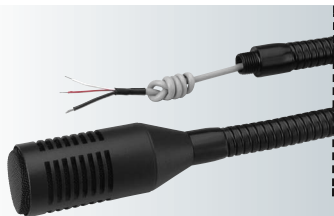

**DMG-400**

Order No. 23.1550

**Dynamic gooseneck microphone**, mat black balanced version of cardioid characteristic. With short, strong gooseneck and M10 threaded part (length: 8mm) for console and front mounting. Excellent sound characteristics.



**DMG-600**

Order No. 23.1560

**Dynamic gooseneck microphone**, mat black balanced version of cardioid characteristic with microphone plug, suitable for audio mixers with XLR front jack.



**EMG-400P**

Order No. 23.1620

**Electret gooseneck microphone**, of cardioid characteristic with a 40cm gooseneck, XLR plug and microphone windshield. Suitable for mixers with phantom output.

Model	DMG-400	DMG-600	EMG-400P
System	dynamic/cardioid	dynamic/cardioid	electret/cardioid
Frequency range	150-12,000Hz	200-12,000Hz	100-16,000Hz
Impedance	500Ω	500Ω	680Ω
Sensitivity	2.2mV/Pa/1kHz	2mV/Pa/1kHz	4.5mV/Pa/1kHz
Max. SPL	-	-	120dB
Power supply	-	-	9-48V=, phantom
Admiss. ambient temp.	-	-	0-40 °C
Dimensions	ø 28mm x 385mm	ø 21mm x 565mm	ø 13/19mm x 455mm
Weight	252g	162g	195g
Connection	bare cable ends	XLR	XLR

## EMG-650P

Order No. 23.4330

**Electret gooseneck microphone**, with switchable low cut filter.  
This microphone features an excellent radiation and a clear voice reproduction.

- Cardioid characteristic
- Wide transmission range
- Switchable low cut 180Hz (12dB/oct)
- Electronically balanced output
- Low acoustic feedback
- Unobtrusive power LED in the XLR connection terminal
- Foam windshield
- Total length: 600mm

## EMG-500P

Order No. 23.1980

**Electret gooseneck microphone**, of cardioid characteristic, especially low impedance, with 32cm gooseneck, XLR plug and microphone windshield. Suitable for mixers with phantom output.

## EMG-330P

Order No. 23.4270

**Miniature electret directional microphone with gooseneck**

- Transformer-balanced
- Hypercardioid/lobe characteristic
- Foam windshield
- 3-pole XLR plug
- Suitable for mixers with phantom output
- With optional desktop microphone base DMS-1 or DMS-3, especially suitable as PA desktop microphone

Model	EMG-650P	EMG-500P	EMG-330P
System	electret/cardioid	electret/cardioid	back electret hypercardioid/lobe
Frequency range	30-18,000Hz	80-16,000Hz	50-18,000Hz
Impedance	180Ω	250Ω	250Ω
Sensitivity	4.5mV/Pa/1kHz	5mV/Pa/1kHz	10mV/Pa/1kHz
Max. SPL	130dB	130dB	125dB
Power supply	9-48V <sub>±</sub> , phantom	9-48 V <sub>±</sub> , phantom	9-48V <sub>±</sub> , phantom
Admiss. ambient temp.	0-40 °C	0-40 °C	0-40 °C
Dimensions	ø 9/19mm x 600mm	ø 19mm x 480mm	ø 19mm x 330mm
Weight	175g	194g	125g
Connection	XLR	XLR	XLR

## Series of Gooseneck Microphones

- Electret or dynamic microphones with a total length of 450mm or 700mm
- 3-pole XLR connection
- EMG-700 and EMG-450 for phantom power with balancing transformer
- DMG-700 and DMG-450 with balanced connection
- Supplied with microphone windshield WS-40

Model	Order No.	System	Frequency range	Impedance	Sensitivity	Power supply	Dimensions
EMG-700	23.2650	electret/cardioid	30-17,000Hz	300Ω	3.2mV/Pa/1kHz	9-48V <sub>±</sub> , phantom	ø 30mm x 700mm
EMG-450	23.2640	electret/cardioid	30-17,000Hz	300Ω	3.2mV/Pa/1kHz	9-48V <sub>±</sub> , phantom	ø 30mm x 450mm
DMG-700	23.2630	dyn./cardioid	80-16,000Hz	500Ω	1.4mV/Pa/1kHz	-	ø 30mm x 700mm
DMG-450	23.2620	dyn./cardioid	80-16,000Hz	500Ω	1.4mV/Pa/1kHz	-	ø 30mm x 450mm

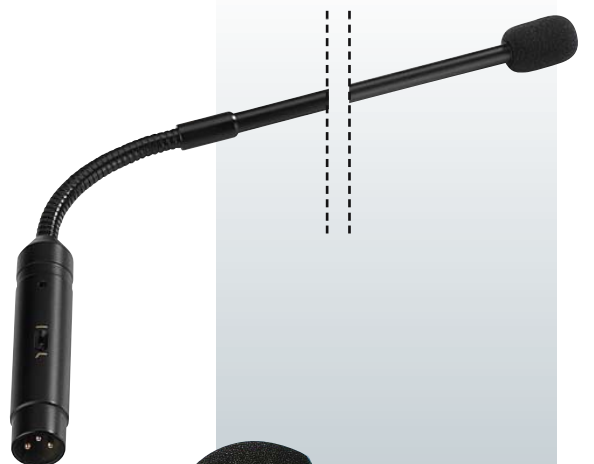

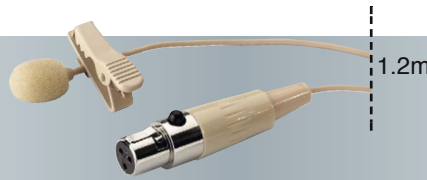

**ECM-601WP**

Order No. 23.6020



**Splashproof electret tie clip microphone, IPX4, miniature version.**

- Back electret microphone cartridge of omnidirectional characteristic
- Especially suitable for outdoor applications and applications with a high ambient humidity
- Removable clip
- 1.5m connection cable, 3-pole mini XLR
- An optional phantom power supply adapter (EMA-1, EMA-2, EMA-40, EMA-300P) or a pocket transmitter TXS-...HSE (except TXS-882HSE) is required for operation

**ECM-501L/SK**

Order No. 23.3900

**Electret tie clip microphone**

Unobtrusive fit due to beige miniature design. High-quality microphone cartridge of omnidirectional characteristic. With removable clip and 1.2m connection cable, 3-pole mini XLR. A phantom power supply adapter (EMA-1, EMA-2, EMA-40, EMA-300P) or a pocket transmitter TXS-...HSE (except TXS-882HSE) is required for operation, available at option.

**ECM-402L**

Order No. 23.3520

**Electret tie clip microphone**

Miniature version. Microphone cartridge of cardioid characteristic. With removable clip and 1.2m connection cable, 3-pole mini XLR. A phantom power supply adapter (EMA-40, EMA-300P) or a pocket transmitter TXS-...HSE (except TXS-882HSE) is required for operation, available at option.

- With adapter NTA-4M (available at option), compatible with pocket transmitter TXS-882HSE
- Optional adapters allow the application with units from other manufacturers
- External power supply e.g. via the phantom power supply adapters EMA-1, EMA-2, EMA-40 or EMA-300P
- Windshield

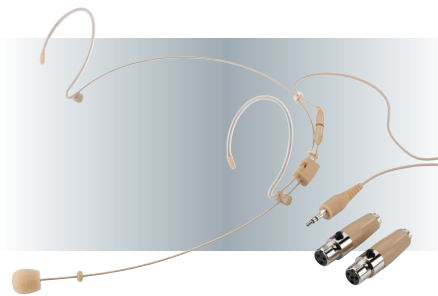

**HSE-152A/SK**

Order No. 23.5170

**Ultralight headband microphone,**

of cardioid characteristic

- Wide transmission range
- Very comfortable to wear
- Turning cartridge arm of adjustable length
- Drip ring
- Removable sweat-proof connection cable
- With the supplied adapters, compatible with all TXS-...HSE- and pocket transmitters from JTS



**HSE-70C**

Order No. 23.5200

**Replacement connection cable,** for the earband microphones HSE-70A/SK, HSE-150A/SK, HSE-152A/SK. Length: 1.2m.



**HSE-80**

Order No. 23.3880

**Electret headband microphone**

- For vocal and speech applications
- Very comfortable to wear
- Secure fit also during extreme applications, e.g. aerobics
- High-quality electret cartridge

- 3-pole mini XLR inline jack for the connection to an optional phantom power supply adapter (EMA-1, EMA-2, EMA-40, EMA-300P) or a pocket transmitter TXS-...HSE (except TXS-882HSE)



**HSE-110**

Order No. 23.2170

**Headband microphone,** with high-quality back electret cartridge. Very linear frequency response, especially resistant to external sound.

The power supply adapter EMA-1 or a respective power supply is required for operation.  
HSE-110: with 3-pole mini XLR inline jack, matching EMA-1 or pocket transmitters TXS-...HSE (except TXS-882HSE)

Model	ECM-601WP	ECM-501L/SK	ECM-402L	HSE-152A/SK	HSE-110
System	back electret/omnidir.	electret/omnidir.	electret/cardioid	back electret/cardioid	back electret supercardioid
Frequency range	30-20,000Hz	20-20,000Hz	70-15,000Hz	20-20,000Hz	20-20,000Hz
Impedance	1.6kΩ	1kΩ	1.5kΩ	1.5kΩ	3kΩ
Sensitivity	7.1mV/Pa/1kHz	5.6mV/Pa/1kHz	7mV/Pa/1kHz	1.8mV/Pa/1kHz	7mV/Pa/1kHz
Max. SPL	115dB	110dB	120dB	120dB	120dB
Power supply	1.5-9V=	1.5-9V=	via power supply adapter	1.5-9V=	1.3-20V=
Admiss. amb. temp.	0-40 °C	0-40 °C	0-40 °C	0-40 °C	0-40 °C
Dimensions	ø 7mm x 17mm	ø 5mm x 10mm	ø 7mm x 22mm	ø 7mm x 22mm	ø 7mm x 22mm
Weight	40g	5g	4g	7g	75g
Connection	3-pole mini XLR	3-pole mini XLR	3-pole mini XLR	2.5mm stereo plug 2 connecting adapters	3-pole mini XLR

Model	HSE-80
System	electret/cardioid
Frequency range	100-12,000Hz
Impedance	2.2kΩ
Sensitivity	4.5mV/Pa/1kHz
Max. SPL	110dB
Power supply	2-10V=
Weight	40g
Connection, cable	3-pole mini XLR
Cable	0.8m



### MS-60/SW

Order No. 23.2930

**Microphone floor stand**, with movable boom (adjustable length: 57-96cm) and shock-absorbing folding feet.

Thread: 16mm (5/8") and 9mm (3/8").

- Mat black lacquered
- Adjustable height: 99-242cm
- Storage dimensions: 10x98cm
- Weight: 2.9kg



### MS-28

Order No. 23.5440

**Microphone floor stand**, mat black lacquered, with shock-absorbing black diecast base (ø 25cm). Very robust and stable version.

- Thread: 9mm (3/8")
- Adjustable height: 88-156cm
- Weight: 4.5kg



### PAST-162/SW

Order No. 12.0910

**PA speaker stand**, lightweight aluminium version, height can be adjusted in 5 steps, with locking pin.

- Aluminium, black
- Adjustable height: 126-195cm
- Max. load at central weight concentration: 40kg



### GN-40XLR

Order No. 23.0750

### GN-40XLR/SW

Order No. 23.5700

**Goosenecks**, 500mm (20").

- Chromium-plated or black (SW)
- 1 x XLR plug
- 1 x XLR inline jack
- 1:1 connection

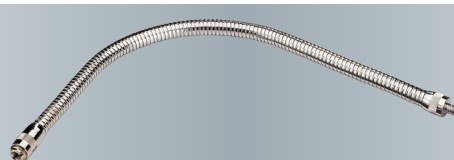

### GN-500

Order No. 23.3120

**Gooseneck**, 500mm (19").

- Chromium-plated
- Inside thread: 16mm (5/8")
- Outside thread: 9mm (3/8")
- Incl. adapter, inside thread: 9mm (3/8"), outside thread: 16mm (5/8")



### MS-210/CR

Order No. 23.3230

### MS-210/SW

Order No. 23.3240

**Desktop microphone stands**

- Diecast base
- Chromium-plated (CR) or black (SW) tube
- Tilttable tube
- Adjustable height: 375-590mm
- Thread: 16mm (5/8") and 9mm (3/8")
- Weight: 1.9kg



### MH-152

Order No. 23.3540

**Microphone holder**, ø 32-42mm, black flexible plastic.

- Especially suitable for wireless hand-held microphones which generally feature a bigger handle
- 16mm (5/8") standard thread



### DMS-1

Order No. 23.3490

**Desktop microphone base**, for gooseneck microphones.

- On/off switch
- Non-slip diecast housing
- Microphone connection via XLR jack with latching device
- XLR output, balanced connection
- Dimensions: 135x55x145mm
- Weight: 1.3kg



### GNS-2

Order No. 23.3620

**Gooseneck mounting plate**, with 16mm (5/8") thread for accepting microphone goosenecks, e.g. GN-500 or GN-300, ø 60mm x 20mm.

**TXS-860**

Order No. 24.0870

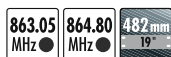

**2-channel receiver unit**, matching transmitters with the same carrier frequency.

- Non-diversity system with folding antennas (BNC connection)
- Squelch and volume controls for each channel
- XLR output for each channel, bal.
- 6.3mm output for mixed signal
- High/low selector switch for level adjustment (mic/line)
- LED level display for audio signal and transmitting signal for each channel
- Supplied with PSU
- 482mm (19") rack installation possible with supplied mounting brackets (1RS)

**Licence-free in the EU.**

**TXS-840**

Order No. 24.0850

**TXS-842**

Order No. 24.0860



**Receiver units**, matching transmitters with the same carrier frequency.

- Switching diversity system with folding antennas
- Squelch control
- Volume control
- XLR output and 6.3mm output
- LEDs for power, AF peak and transmitter status
- Supplied with PSU

**Licence-free in the EU.**



Model	TXS-860	TXS-840	TXS-842
Carrier frequency	863.05MHz, 864.80MHz	863.05MHz	864.80MHz
Audio frequency range	50-15,000Hz	50-15,000Hz	50-15,000Hz
THD	< 0.6%	< 0.6%	< 0.6%
Dynamic range	> 110dB	> 110dB	> 110dB
Audio signal	0-0.75V/5kΩ (jack) 60mV/600Ω (XLR, bal.)	0.75V/5kΩ (jack) 60mV/600Ω (XLR, bal.)	0.75V/5kΩ (jack) 60mV/600Ω (XLR, bal.)
Admiss. ambient temp.	0-40 °C	0-40 °C	0-40 °C
Power supply	via suppl. plug-in PSU	via suppl. plug-in PSU	via suppl. plug-in PSU
Dimensions	410x52x260mm	220x114x40mm	220x114x40mm
Weight	2.4kg	550g	550g

### Hand-held Microphones with Integrated Transmitter

- Dynamic, cardioid characteristic
  - Switch for transmission mode, power LED
  - Power supply via 9V battery (not supplied)
  - Transmitting power: < 10mW (EIRP)
  - Operating range: approx. 30m
- Licence-free in the EU.**

863.05  
MHz

864.80  
MHz



Model	Order No.	Carrier frequency	Audio frequency range	Frequency stability	Dimensions	Weight
<i>TXS-821HT</i>	24.8500	863.05MHz	50-15,000Hz	±0.005%	ø 50mm x 246mm	225g
<i>TXS-822HT</i>	24.0910	864.80MHz	50-15,000Hz	±0.005%	ø 50mm x 246mm	225g

### Pocket Transmitters

- Suitable for the combination with every HSE headband microphone with 3-pole mini XLR plug
  - Transmitting power: < 5mW (EIRP)
  - Operating range: approx. 30m
- Volume control
  - Power LED
  - Belt clip
  - Power supply via 9V battery (not supplied)
- Licence-free in the EU.**

863.05  
MHz

864.80  
MHz



Model	Order No.	Carrier frequency	Audio frequency range	Frequency stability	Dimensions	Weight
<i>TXS-820HSE</i>	24.0880	863.05MHz	50-15,000Hz	±0.005%	66x108x35mm	100g
<i>TXS-822HSE</i>	24.0890	864.80MHz	50-15,000Hz	±0.005%	66x108x35mm	100g

### Headband Microphone Transmitters

- Electret headband microphone with 3.5mm plug with latching device
  - Transmitting power: < 5mW (EIRP)
  - Operating range: approx. 30m
  - Volume control, power LED, belt clip
  - Power supply via 9V battery (not supplied)
- Licence-free in the EU.**

863.05  
MHz

864.80  
MHz



Model	Order No.	Carrier frequency	Audio frequency range	Frequency stability	Dimensions	Weight
<i>TXS-820SX</i>	24.0940	863.05MHz	50-15,000Hz	±0.005%	66x108x35mm	100g
<i>TXS-822SX</i>	24.0950	864.80MHz	50-15,000Hz	±0.005%	66x108x35mm	100g

### Tie Clip Microphone Transmitters

- Cable with 3.5mm plug with latching device
  - Volume control
  - Belt clip
  - Switch for transmission mode, power LED
  - Power supply via 9V battery (not supplied)
  - Transmitting power: < 5mW (EIRP)
  - Operating range: approx. 30m
- Licence-free in the EU.**

863.05  
MHz

864.80  
MHz



Model	Order No.	Carrier frequency	Audio frequency range	Frequency stability	Dimensions	Weight
<i>TXS-820LT</i>	24.0920	863.05MHz	50-15,000Hz	±0.005%	66x108x35mm	95g
<i>TXS-822LT</i>	24.0930	864.80MHz	50-15,000Hz	±0.005%	66x108x35mm	95g

### TXS-820M

Order No. 24.4470

### TXS-822M

Order No. 24.4480

863.05  
MHz

864.80  
MHz

**Receiver modules**, from the TXS-800/802 series, matching the TXS-82... transmitters, for subsequent installation.

- For general applications, only an antenna and the 8V DC voltage which is required for operation are needed
- For subsequent installation, e.g. into amplifiers, mixers or active speaker systems

- Non-diversity system
  - Small dimensions due to compact SMD technology
  - Connection via supplied cable
  - Outputs for audio, display of field strength (S-meter), carrier LED and external squelch control
  - Audio frequency range: 50-15,000Hz
- TXS-820M = 863.05MHz**  
**TXS-822M = 864.80MHz**

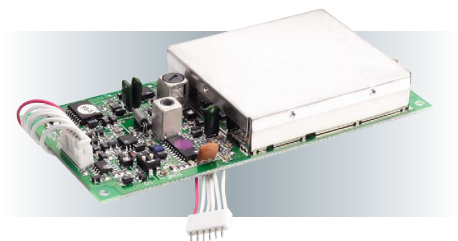

**TXS-871**

Order No. 25.3600

**TXS-872**

Order No. 25.2770

**Multifrequency receiver units**, with UHF PLL technology.

- TXS-871: 15 selectable UHF frequencies (863-865MHz), TXS-872: 193 selectable UHF frequencies (740-764MHz)
- True diversity system with removable antennas (BNC connection)
- Automatic scan
- Pilot tone squelch, noise mute
- Selectable lock mode
- LCD for frequency, antenna A/B, RF transmitting level, AF audio level, battery status of the transmitter
- XLR output and 6.3mm output
- Supplied with PSU
- Supplies operating voltage to TXS-872BOOST (TXS-872)



Model	TXS-871	TXS-872
Carrier frequency	863.125-864.875MHz	740-764MHz
Audio frequency range	40-18,000Hz	40-18,000Hz
THD	< 0.6%	< 0.6%
Dynamic range	> 105dB	> 105dB
Audio signal	900mV/1kΩ (jack) 150mV/150Ω (XLR, bal.)	900mV/1kΩ (jack) 150mV/150Ω (XLR, bal.)
Admiss. ambient temp.	0-40 °C	0-40 °C
Power supply	via suppl. PSU	via suppl. PSU
Dimensions	211x40x130mm	211x40x130mm
Weight	1,100g	1,100g

**TXS-871HT**

Order No. 25.3610

**TXS-872HT**

Order No. 25.2790

**Hand-held microphones with integrated multifrequency transmitter**, with UHF PLL technology.

- Dynamic microphone cartridge
- Diecast aluminium body
- TXS-871HT: 15 selectable UHF frequencies (863-865MHz), transmitting power: < 10mW (EIRP)
- TXS-872HT: 193 selectable UHF frequencies (740-764MHz), transmitting power: 10mW (EIRP)
- Adjustable sensitivity (0dB, -10dB, -20dB, -30dB)
- LCD for frequency and battery status

- Selectable lock mode
- Power supply via 2 x 1.5V battery AA size (not supplied)
- Supplied with plastic case, microphone holder and 7 coloured caps to be pushed on

**TXS-871HT: licence-free system in the EU. TXS-872HT: licence required for this system in the EU.**

**Please read the notes regarding wireless systems in the section "IMPORTANT INFORMATION"!**

Replacement cartridge available: MD-872: condenser cartridge with an even more brilliant sound, supercardioid characteristic



**TXS-871HSE**

Order No. 25.3620

**TXS-872HSE**

Order No. 25.2780

**Multifrequency pocket transmitters**, with UHF PLL technology.

- Suitable for the combination with head-band microphone or earband microphone with 3-pole mini XLR connector
- TXS-871HSE: 15 selectable UHF frequencies (863-865MHz), transmitting power: < 10mW (EIRP)
- TXS-872HSE: 193 selectable UHF frequencies (740-764MHz), transmitting power: 10mW (EIRP)

- Adjustable sensitivity
- LCD for frequency and battery status
- Selectable lock mode
- Power supply via 2 x 1.5V battery AA size (not supplied)
- Supplied in a plastic case

**TXS-871HSE: licence-free system in the EU. TXS-872HSE: licence required for this system in the EU!**

**Please read the notes regarding wireless systems in the section "IMPORTANT INFORMATION"!**



Model	TXS-871HT	TXS-872HT	TXS-871HSE	TXS-872HSE
Carrier frequency	863.125-864.875MHz	740-764MHz	863.125-864.875MHz	740-764MHz
Audio frequency range	50-16,000Hz	50-16,000Hz	40-18,000Hz	40-18,000Hz
Frequency stability	±0.005%	±0.005%	±0.005%	±0.005%
Operating time	> 30h	> 30h	> 30h	> 30h
Dimensions	ø 50mm x 260mm	ø 50mm x 260mm	78x190x34mm	78x190x34mm
Weight	350g	350g	160g	160g



## RCB-870

Order No. 24.2830



**482mm (19", 1RS) unit holder**, for the installation of two multifrequency receiver units TXS-871, TXS-872 or TXS-852. Supplied with dummy cover.

Dimensions: 482x44x108mm

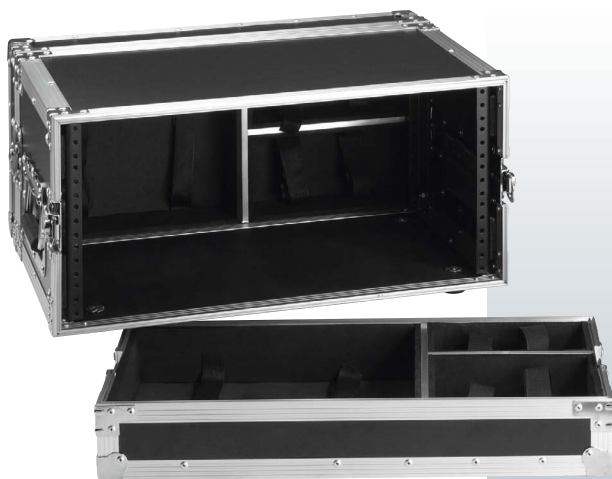

## MR-405TXS

Order No. 24.4460



**Flight case, 5RS**, especially for wireless microphone systems, e.g. 4 x receiver unit TXS-871/TXS-872 and 1 x antenna splitter TXS-870DS. Also suitable for other wireless microphone systems and 482mm units with a max. depth of 255mm behind the front panel.

- Storage compartments with holding straps for transmitter and accessories
- Multilayer multiplex wood, black, plastic-laminated, aluminium profile edges, butterfly locks, folding recessed handles
- Supplied with mounting screws
- Dimensions: 540x265x460mm
- Weight: 9.3kg

## MD-872

Order No. 23.3440

**Condenser microphone cartridge for TXS-872HT/TXS-871HT**

- Supercardioid characteristic
- Ideally suited for vocals, especially for musicians and stage applications
- With extended frequency range, more precise bass frequencies and more brilliant high frequencies
- Frequency range: 50-18,000Hz
- Impedance: 2.2kΩ
- Sensitivity: 7mV/Pa/1kHz
- S/N ratio: 77dB



## TXS-870DS

Order No. 15.0120



**4-way antenna splitter**, for operating up to four multifrequency receiver units TXS-871/TXS-872 with one pair of multi-antennas. With this unit, it is no longer necessary to use the respective antennas and plug-in PSUs of the individual units. The power is supplied via the four available low-voltage outputs. Supplied with matching connection cables. Each antenna connection via BNC jack.

- Frequency range: 470-870MHz
- Dimensions: 482x44x260mm, 1RS
- Weight: 2.2kg
- Power supply: 230V~/50Hz/12VA
- Low-voltage outputs for power supply of 4 x TXS-871/TXS-872
- Supplies operating voltage to TXS-872BOOST



## TXS-81ANT

Order No. 25.3730

**Replacement rod antenna**, for UHF frequency receiver unit TXS-871.

- Perfect reception due to half-wave length tuning
- Folding 90°, with 45° locking
- Flexible, with insulating plastic sheathing
- BNC connection
- Total length: 245mm

## TXS-82ANT

Order No. 25.3180

**Replacement rod antenna**, especially suitable for UHF frequency receiver units TXS-872, TXS-892 and antenna amplifier TXS-872BOOST.

- Perfect reception due to half-wave length tuning
- Folding 90°, with 45° locking
- Flexible, with insulating plastic sheathing
- BNC connection
- Total length: 245mm

## TXS-872BOOST

Order No. 15.0740



**Pair of antenna amplifiers**, as RF signal amplification for the multifrequency receiver units TXS-872, TXS-892.

- Gain: 10dB
- BNC connections
- Power supply via receiver unit TXS-872, TXS-892 or TXS-870DS
- Supplied with folding antennas and mounting brackets





**TXA-1000**

Order No. 17.2790

**TXA-1000CD**

Order No. 17.2800

**TXA-1002CD**

Order No. 17.2810



Matching microphone transmitters or pocket transmitters are available at option, e.g. TXA-800HSE or TXA-800HT.

Portable high-power amplifier systems, with integrated adjustable multifrequency receiver unit in UHF PLL technology.

- High-performance class D version 170W<sub>MAX</sub>, with optimum efficiency
- Operation via mains connection or built-in rechargeable lead gel battery 2 x 12V/4.5Ah (operating time: up to 4 hours), integrated automatic charging of rechargeable battery, discharge protection
- For mobile applications, e.g. at sales events, lectures
- 16 selectable UHF frequencies (863.1-864.9MHz) with diversity system
- 2-way speaker system of high power capability with a 25cm (10") bass speaker
- 1 microphone input via comb. jack (XLR/6.3mm), 1 microphone input (6.3mm jack), 1 stereo line input (RCA), 1 aux input (3.5mm jack), each input can be adjusted
- Common master control, 2-way tone control
- 1 stereo line output (RCA), 1 aux output (3.5mm jack)
- Switchable microphone priority circuit
- Due to the extractable telescopic handle and 2 castors, the amplifier system can easily be pulled like a trolley
- Stand sleeve

Licence-free in the EU.

**TXA-1000:**

- Amplifier system with 1 wireless receiver

**TXA-1000CD:**

- Amplifier system with 1 wireless receiver
- CD player with anti-shock system, MP3 reproduction and slot-in mechanism
- SD card reader, USB interface
- Pitch control function
- Supplied with remote control for the CD player

**TXA-1002CD:**

- Amplifier system with 2 wireless receivers
- CD player with anti-shock system, MP3 reproduction and slot-in mechanism
- SD card reader, USB interface
- Pitch control function
- 1 wireless transmitter for the wireless audio link operation of several TXA-1000 systems or in combination with TXA-800 systems
- Supplied with remote control for the CD player



**Audio link operation:**

The integrated wireless transmitter of the TXA-1002CD transmits audio signals to one or several TXA-1000 or TXA-800 systems. Ideally suited for larger indoor PA applications where the sound has to be radiated as evenly as possible.

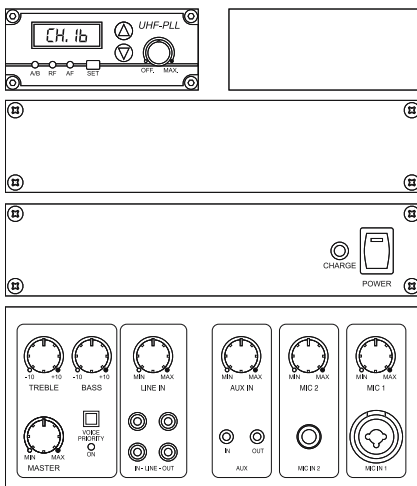

TXA-1000

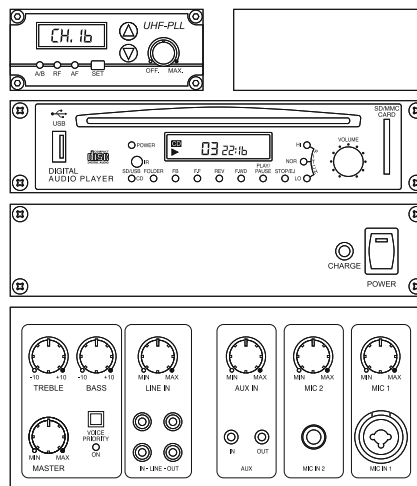

TXA-1000CD

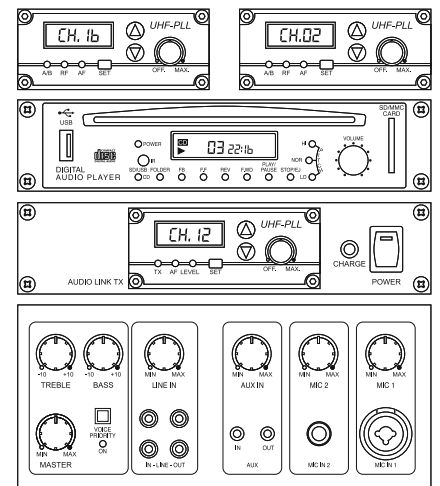

TXA-1002CD

Model	TXA-1000	TXA-1000CD	TXA-1002CD
Output power	170W <sub>MAX</sub> /120W <sub>RMS</sub>	170W <sub>MAX</sub> /120W <sub>RMS</sub>	170W <sub>MAX</sub> /120W <sub>RMS</sub>
Frequency range	20-20,000Hz	20-20,000Hz	20-20,000Hz
Carrier frequency	863.1-864.9MHz	863.1-864.9MHz	863.1-864.9MHz
Operating range	approx. 30m	approx. 30m	approx. 30m
Sensitivities			
Mic inputs	6mV	6mV	6mV
Line inputs	150mV (incl. aux)	150mV (incl. aux)	150mV (incl. aux)
Link	-	-	-
Equalizer, bass	±10dB/100Hz	±15dB/100Hz	±15dB/100Hz
Equalizer, midrange	-	-	-
Equalizer, treble	±10dB/10kHz	±10dB/10kHz	±10dB/10kHz
Power supply	230V~/50Hz/170VA, rech. battery: 2 x 12V/4.5Ah	230V~/50Hz/170VA, rech. battery: 2 x 12V/4.5Ah	230V~/50Hz/170VA, rech. battery: 2 x 12V/4.5Ah
Admiss. ambient temp.	0-40 °C	0-40 °C	0-40 °C
Dimensions	360x580x320mm	360x580x320mm	360x580x320mm
Weight	17.8kg	18kg	18.5kg



### TXA-800HT

Order No. 17.2260

**Hand-held microphone with integrated multifrequency transmitter**, with UHF PLL technology. Matching the portable amplifier systems of the TXA-1000 and TXA-800 series.

- Dynamic microphone cartridge, of cardioid characteristic
- 16 selectable UHF frequencies (863.1-864.9MHz)
- Sensitivity to be adjusted in 2 steps
- Mute function
- Backlit LCD for channel/frequency and battery status
- Transmitting power: 10mW (EIRP)
- Power supply via 2 x 1.5V battery AA size (not supplied)
- Supplied with 4 coloured caps to be pushed on

**Licence-free in the EU.**

### TXA-800HSE

Order No. 17.2250

**Multifrequency pocket transmitter**, with UHF PLL technology. Matching the portable amplifier systems of the TXA-1000 and TXA-800 series.

- 1 headband microphone (omnidir. char.), 1 tie clip microphone (cardioid char.)
- 16 selectable UHF frequencies (863.1-864.9MHz)
- Metal housing
- Microphone connection via 3-pole mini XLR jack
- Audio line input via 3.5mm stereo jack
- Sensitivity to be adjusted in 3 steps
- Mute function
- Backlit LCD for channel/frequency and battery status
- Transmitting power: 10mW (EIRP)
- Power supply via 2 x 1.5V battery AA size (not supplied)
- Belt clip

**Licence-free in the EU.**

### TXA-1000BAG

Order No. 17.2820

**Protective bag**, suitable for portable amplifier systems TXA-1000, TXA-1000CD and TXA-1002CD.

- Robust synthetic fibre material, black
- Sound-transparent front of meshed fabric
- The bag can stay on during operation!
- Opening for transport handle and trolley handle
- 2 lateral pockets, each with hook and loop fastener

**Supplied without unit.**

Model	TXA-800HT	TXA-800HSE
Carrier frequency	863.1-864.9MHz	863.1-864.9MHz
Audio frequency range	70-16,000Hz	70-16,000Hz
Frequency stability	±0.005%	±0.005%
Dimensions	ø 46mm x 265mm	65x95x30mm
Weight	250g	110g

### TXA-1015ACCU

Order No. 17.3210

**Rechargeable lead battery, 12V**, universal rech. battery, also suitable as a replacement for the TXA-1000 series.

- Capacity: 12V/4.5Ah
- Maintenance-free, hermetically sealed
- Dimensions: 90x110x70mm
- Weight: 1.8kg

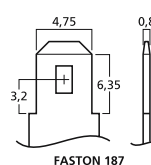
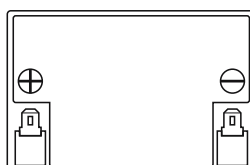

FASTON 187



**TXA-800**

Order No. 17.2220

**TXA-800CD**

Order No. 17.2230

**TXA-802CD**

Order No. 17.2240



Portable amplifier systems, with integrated, adjustable multifrequency receiver unit in UHF PLL technology.

- Operation via mains connection or built-in rechargeable lead gel battery 2 x 12V/3Ah (operating time: up to 4 hours), integrated automatic charging of rechargeable battery, discharge protection
- For mobile applications, e.g. at sales events, lectures
- 16 selectable UHF frequencies (863.1-864.9MHz) with diversity system
- 2-way speaker system of high power capability
- 1 adjustable microphone input via comb. jack (XLR/6.3mm), 1 stereo line input (RCA), common master control and 2-way tone control
- 1 stereo line output (RCA)
- 6.3mm jack connection (8Ω) for external speaker
- Stand sleeve

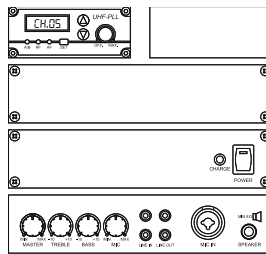

TXA-800

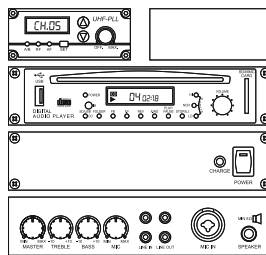

TXA-800CD

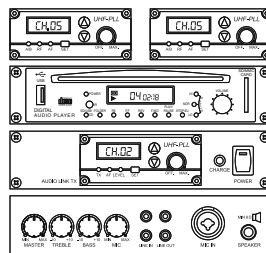

TXA-802CD



Matching microphone transmitters or pocket transmitters are available at option, e.g. TXA-800HSE or TXA-800HT.

**Audio link operation:**

The integrated wireless transmitter of the TXA-802CD and TXA-1002CD transmits audio signals to one or several TXA-800 or TXA-1000 systems. Ideally suited for larger indoor PA applications where the sound has to be radiated as evenly as possible.

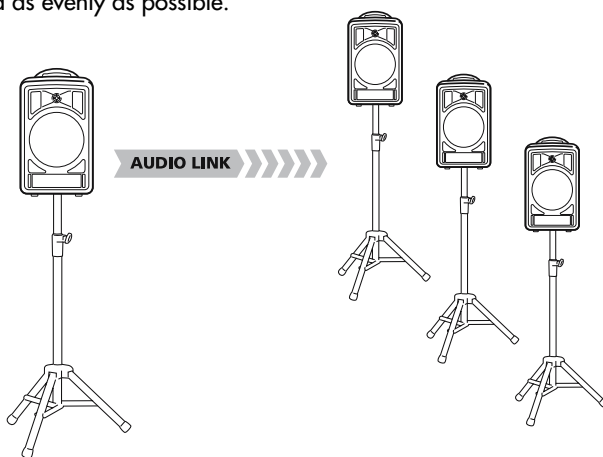

Model	TXA-800	TXA-800CD	TXA-802CD
Output power	80W <sub>MAX</sub> /50W <sub>RMS</sub>	80W <sub>MAX</sub> /50W <sub>RMS</sub>	80W <sub>MAX</sub> /50W <sub>RMS</sub>
Frequency range	70-16,000Hz	70-16,000Hz	70-16,000Hz
Carrier frequency	863.1-864.9MHz	863.1-864.9MHz	863.1-864.9MHz
Operating range	approx. 30m	approx. 30m	approx. 30m
Sensitivities			
Mic inputs	6mV	6mV	6mV
Line inputs	130mV	130mV	130mV
Link	-	-	-
Equalizer, bass	±15dB/100Hz	±15dB/100Hz	±15dB/100Hz
Equalizer, midrange	-	-	-
Equalizer, treble	±10dB/10kHz	±10dB/10kHz	±10dB/10kHz
Power supply	230V~/50Hz/150VA, rech. batt.: 2 x 12V/3Ah	230V~/50Hz/150VA, rech. batt.: 2 x 12V/3Ah	230V~/50Hz/150VA, rech. batt.: 2 x 12V/3Ah
Admiss. ambient temp.	0-40 °C	0-40 °C	0-40 °C
Dimensions	300x470x230mm	300x470x230mm	300x470x230mm
Weight	11.2kg	11.9kg	12.3kg

**Licence-free in the EU.**

**TXA-800:**

- Amplifier system with 1 wireless receiver

**TXA-800CD:**

- Amplifier system with 1 wireless receiver
- CD player with anti-shock system, MP3 reproduction and slot-in mechanism
- SD card reader, USB interface
- Pitch control function

**TXA-802CD:**

- Amplifier system with 2 wireless receivers
- CD player with anti-shock system, MP3 reproduction and slot-in mechanism
- SD card reader, USB interface
- Pitch control function
- 1 wireless transmitter for the wireless audio link operation of several TXA-800 systems

tastenvelt 02/2008 on the TXA-800

"Gives a reliable impression, features a well-balanced sound, audio link to TXA-802CD possible."

tastenvelt 02/2008 on the TXA-802CD

"Flexibility is the word. The features of this system turn it into a universal tool. Easy-to-use plug-and-play system with a well-balanced sound."



### TXA-800HT

Order No. 17.2260

**Hand-held microphone with integrated multifrequency transmitter**, with UHF PLL technology. Matching the portable amplifier systems of the TXA-1000 and TXA-800 series.

- Dynamic microphone cartridge, of cardioid characteristic
- 16 selectable UHF frequencies (863.1-864.9MHz)
- Sensitivity to be adjusted in 2 steps
- Mute function
- Backlit LCD for channel/frequency and battery status
- Transmitting power: 10mW (EIRP)
- Power supply via 2 x 1.5V battery AA size (not supplied)
- Supplied with 4 coloured caps to be pushed on

**Licence-free in the EU.**

### TXA-800HSE

Order No. 17.2250

**Multifrequency pocket transmitter**, with UHF PLL technology. Matching the portable amplifier systems of the TXA-1000 and TXA-800 series.

- 1 headband microphone (omnidir. char.), 1 tie clip microphone (cardioid char.)
- 16 selectable UHF frequencies (863.1-864.9MHz)
- Metal housing
- Microphone connection via 3-pole mini XLR jack
- Audio line input via 3.5mm stereo jack
- Sensitivity to be adjusted in 3 steps
- Mute function
- Backlit LCD for channel/frequency and battery status
- Transmitting power: 10mW (EIRP)
- Power supply via 2 x 1.5V battery AA size (not supplied)
- Belt clip

**Licence-free in the EU.**

### TXA-800BAG

Order No. 17.2340

**Protective bag**, suitable for portable amplifier systems TXA-800, TXA-800CD and TXA-802CD.

- Robust synthetic fibre material, black
- Sound-transparent front of meshed fabric
- The bag can stay on during operation!
- Opening for transport handle
- 2 lateral pockets, each with hook and loop fastener

**Supplied without unit.**

#### tastentwelt 02/2008

"The use of the headset is interesting for keyboard players."

Model	TXA-800HT	TXA-800HSE
Carrier frequency	863.1-864.9MHz	863.1-864.9MHz
Audio frequency range	70-16,000Hz	70-16,000Hz
Frequency stability	±0.005%	±0.005%
Dimensions	ø 46mm x 265mm	65x95x30mm
Weight	250g	110g



### TXA-802MR

Order No. 17.2500

**Multifrequency receiver module**, with UHF PLL technology.

As a replacement for the amplifier systems of the TXA-1000 and TXA-800 series or for setting up wireless audio transmission paths.

- 16 selectable UHF frequencies (863.1-864.9MHz) with diversity system
- Volume control
- LCD for selected channel/frequency
- LEDs for carrier and audio signals
- Power supply: 12V=~/185mA

### TXA-802MT

Order No. 17.2510

**Multifrequency transmitter module**, with UHF PLL technology.

As a replacement for the amplifier systems of the TXA-800 series or for setting up wireless audio transmission paths.

- 16 selectable UHF frequencies (863.1-864.9MHz)
- Volume control
- LCD for selected channel/frequency
- LEDs for carrier and audio signals
- Power supply: 12V=~/120mA

**Licence-free in the EU.**

### TXA-815ACCU

Order No. 17.2930

**Rechargeable lead battery, 12V**, universal rech. battery, also suitable as a replacement for TXA-110, TXA-150, TXA-150USB and the TXA-800 series.

- Capacity: 12V/2.9Ah
- Maintenance-free, hermetically sealed
- Dimensions: 79x107x56mm
- Weight: 1.2kg

*The TXA-900CD is the perfect solution of the TXA series from MONACOR whenever a powerful voice amplification with a perfect sound is required. This rechargeable amplifier system impresses by a distortion-free reproduction at a particularly high volume level.*

**TXA-900CD**

Order No. 17.2860



**Portable high-power amplifier system**, with integrated wireless receiver and CD player with anti-shock system.

- Operation via mains connection or built-in rechargeable lead gel battery 12V/7Ah (operating time: up to 8 hours), integrated automatic charging of rechargeable battery
- For mobile applications, e.g. at speeches, lectures, sales events
- High-quality CD player with slot-in mechanism, USB connection for external storage media, reproduction of audio CDs, CD-Rs, MP3 CDs, high-speed access
- 2-way speaker system with professional PA speakers
- Very high efficiency
- 2 inputs (channels 1+2) via comb. jacks mic (XLR)/line (6.3mm), each with gain control, 3-way equalizer, bass boost function
- Link connections (2 x 6.3mm jack) for the combination of several amplifier systems TXA-900CD
- Due to the built-in extractable telescopic handle and 2 castors, the amplifier system can easily be pulled like a trolley
- Wooden cabinet of perfect workmanship
- Lateral recessed carrying handles
- Stand sleeve
- Supplied with practical protective bag

**Licence-free in the EU.**



Matching microphone transmitters or pocket transmitters are available at option, e.g. TXS-821HT, TXS-820HSE, TXS-820LT or TXS-820SX.

Model	TXA-900CD
Output power	75W <sub>MAX</sub> /50W <sub>RMS</sub>
Frequency range	60-19,000Hz
Carrier frequency	863.05MHz
Operating range	approx. 30m
Sensitivities	
Mic inputs	2.5mV
Line inputs	130mV
Link	740mV
Equalizer, bass	±12dB/40Hz
Equalizer, midrange	±6dB/1kHz
Equalizer, treble	±12dB/12kHz
Power supply	230V~/50Hz/40VA, rech. battery: 12V/7Ah
Admiss. ambient temp.	0-40 °C
Dimensions	310x560x285mm
Weight	13.9kg

### TXA-15USB

Order No. 17.3150



**Portable amplifier system**, with integrated USB/SD card player.

- Operation via mains connection or built-in lead gel battery 12V/7.2Ah (operating time: up to 6 hours)
- Integrated automatic charging of rechargeable battery
- For mobile applications, e.g. at sales events, lectures
- Adjustable USB/SD card player with connection for external storage media, illuminated display
- 2-way speaker system
- 1 adjustable balanced microphone input via XLR, 1 adjustable microphone input via 6.3mm mono jack, 1 adjustable CD/Tape input via RCA
- Adjustable master output with 3-way equalizer
- Link connection (6.3mm jack) for combining several TXA-15USB or TXA-15A systems
- Housing in flight case design, with folding handles
- Due to the integrated extractable telescopic handle and 2 castors, the amplifier system can easily be pulled like a trolley
- Stand sleeve

### TXA-15A

Order No. 17.3180

**Portable amplifier system**, with integrated docking station for portable players.

- Operation via mains connection or built-in lead gel battery 12V/7.2Ah (operating time: up to 6 hours)
- Integrated automatic charging of rechargeable battery
- For mobile applications, e.g. at sales events, lectures
- Docking station with charging feature, can be switched on additionally, with 30-pole connector
- 2-way speaker system
- 1 adjustable balanced microphone input via XLR, 1 adjustable microphone input via 6.3mm mono jack, 1 adjustable CD/tape input via RCA
- Adjustable master output with 3-way equalizer
- Link connection (6.3mm jack) for combining several TXA-15A or TXA-15USB systems
- Housing in flight case design, with folding handles
- Due to the integrated extractable telescopic handle and 2 castors, the amplifier system can easily be pulled like a trolley
- Lockable storage compartment for supplied microphone and microphone cable
- Stand sleeve



Model	TXA-15USB	TXA-15A
Output power	20W <sub>MAX</sub> /15W <sub>RMS</sub>	20W <sub>MAX</sub> /15W <sub>RMS</sub>
Frequency range	70-20,000Hz	70-20,000Hz
Sensitivities		
Mic inputs	6mV	6mV
Line inputs	600mV	600mV
Link	380mV	380mV
Equalizer, bass	±15dB/100Hz	±15dB/100Hz
Equalizer, midrange	±15dB/2.5kHz	±15dB/2.5kHz
Equalizer, treble	±15dB/10kHz	±15dB/10kHz
Power supply	230V~/50Hz/60VA, rech. battery: 12V/7.2Ah	230V~/50Hz/60VA, rech. battery: 12V/7.2Ah
Admiss. ambient temp.	0-40 °C	0-40 °C
Dimensions	410x470x310mm	410x470x310mm
Weight	17.2kg	17.2kg

**TXA-620CD**

Order No. 17.1290



**Portable amplifier system**, with integrated wireless receiver and CD player with anti-shock system.

- Operation via mains connection or built-in rechargeable lead gel battery 12V/7Ah (operating time: up to 8 hours), integrated automatic charging of rechargeable battery
  - For mobile applications, e.g. at sales events, lectures
  - High-quality CD player with slot-in mechanism, USB connection for external storage media, reproduction of audio CDs, CD-Rs, MP3 CDs
  - 2-way speaker system
  - 2 inputs (channels 1+2) via comb. jacks mic (XLR)/line (6.3mm), each with gain control, 2-way tone control
  - 2 stereo line inputs (channels 3+4) via RCA jacks, gain controls, common 2-way tone control
  - Adjustable talkover
  - Link connections (2 x 6.3mm jack) for the combination of several amplifier systems TXA-610CD, TXA-620CD or TXA-600
  - 6.3mm jack connection (4Ω) for external speaker TXB-600
  - Stand sleeve
  - Supplied with remote control
  - Supplied with practical protective shoulder bag which can stay on during operation
- Licence-free in the EU.**



Matching microphone transmitters or pocket transmitters are available at option, e.g. TXS-821HT, TXS-820HSE, TXS-820LT or TXS-820SX.

Model	TXA-620CD
Output power	50W <sub>MAX</sub> /36W <sub>RMS</sub>
Frequency range	60-18,500Hz
Carrier frequency	863.05MHz
Operating range	approx. 30m
Sensitivities	
Mic inputs	1.5mV
Line inputs	150mV
Link	650mV
Equalizer, bass	±12dB/40Hz
Equalizer, midrange	-
Equalizer, treble	±12dB/12kHz
Power supply	230V~/50Hz/45VA, rech. battery: 12V/7Ah
Admiss. ambient temp.	0-40 °C
Dimensions	235x450x280mm
Weight	9.7kg



# Portable Amplifier System, Additional Speaker System

## TXA-600

Order No. 17.1200



Portable amplifier system, with integrated wireless receiver.

- For mobile applications, e.g. at sales events, lectures
- 2-way speaker system
- 2 inputs (channels 1+2) via comb. jacks mic (XLR)/line (6.3mm), each with gain control, 2-way tone control
- 2 stereo line inputs (channels 3+4) via RCA jacks, each with gain control, common 2-way tone control
- Cutout (approx. 16x17x3cm) at the rear panel for a portable CD player (supplied without CD player), with audio cable and power supply cable
- Adjustable talkover

- Link connections (2 x 6.3mm jack) for the combination of several amplifier systems TXA-600
- 6.3mm connection (4Ω) for external speaker TXB-600
- Operation via mains connection or built-in rechargeable lead gel battery 12V/7Ah (operating time: up to 8 hours), integrated automatic charging of rechargeable battery
- Stand sleeve
- Supplied with practical protective shoulder bag which can stay on during operation

Licence-free in the EU.

Matching microphone transmitters or pocket transmitters are available at option, e.g. TXS-821HT, TXS-820HSE, TXS-820LT or TXS-820SX.

Model	TXA-600
Output power	50W <sub>MAX</sub> /36W <sub>RMS</sub>
Frequency range	60-18,500Hz
Carrier frequency	863.05MHz
Operating range	approx. 30m
Sensitivities	
Mic inputs	1.5mV
Line inputs	150mV
Link	650mV
Equalizer, bass	±12dB/40Hz
Equalizer, midrange	-
Equalizer, treble	±12dB/12kHz
Power supply	230V~/50Hz/45VA, rech. battery: 12V/7Ah
Admiss. ambient temp.	0-40 °C
Dimensions	235x450x280mm
Weight	9.7kg

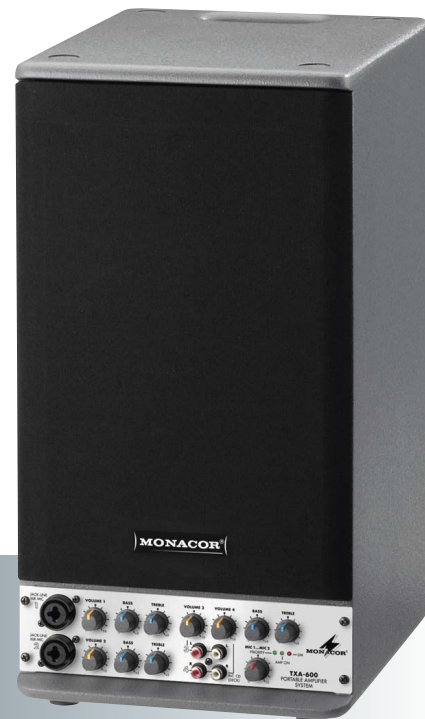

## TXB-600

Order No. 13.1460

Speaker system, 50W<sub>MAX</sub>, 36W<sub>RMS</sub>, 4Ω, suitable for the portable amplifier system TXA-600.

- 2-way system
- Frequency range: 60-18,500Hz
- Stand sleeve
- 6.3mm jack connection
- Supplied with practical protective shoulder bag which can stay on during operation
- Dimensions: 235x450x280mm
- Weight: 3.5kg

Matching speaker cables of the MSC series are available in lengths of 1.5, 3, 6, 10 and 15m.

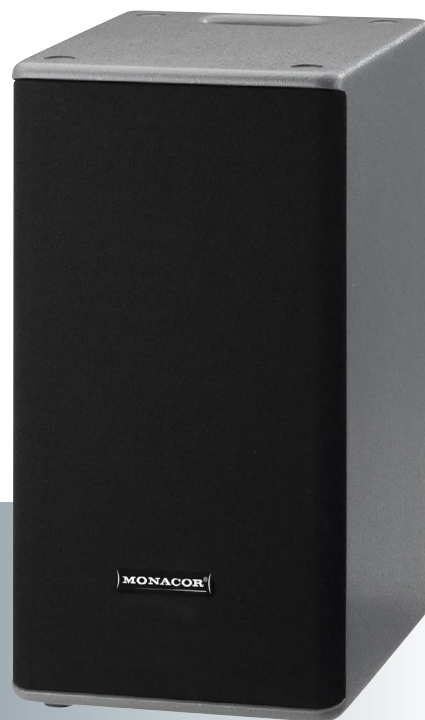



**TXA-500**

Order No. 17.1170



Portable amplifier system, with integrated wireless receiver.

- For mobile applications, e.g. at sales events, lectures
- 1 input (channel 1) via comb. jack mic (XLR)/line (6.3mm)
- 1 stereo line input (channel 2) via RCA jacks
- 1 stereo line input (channel 3) via 3.5mm jack
- Each input with gain control and 2-way tone control
- Link connections for the combination of several amplifier systems TXA-500
- Operation via mains connection or built-in rechargeable lead gel battery 12V/7Ah (operating time: up to 8 hours), integrated charging feature for rechargeable battery
- Stand sleeve
- Supplied with practical protective shoulder bag which can stay on during operation

Licence-free in the EU.



Model	TXA-500
Output power	36V <sub>MAX</sub> /20V <sub>RMS</sub>
Frequency range	60-16,000Hz
Carrier frequency	863.05MHz
Operating range	approx. 30m
Sensitivities	
Mic inputs	1.5mV
Line inputs	150mV (channels 1+2), 100mV (channel 3)
Link	650mV
Equalizer, bass	±12dB/40Hz
Equalizer, midrange	-
Equalizer, treble	±12dB/12kHz
Power supply	230V~/50Hz/60VA, rech. battery: 12V/7Ah
Admiss. ambient temp.	0-40 °C
Dimensions	235x355x220mm
Weight	8.2kg

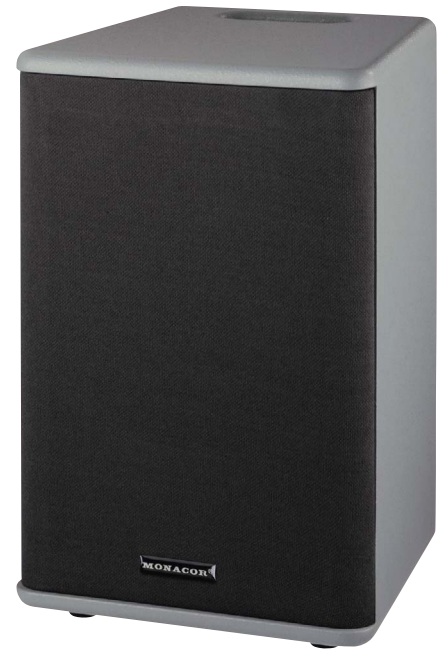

Matching microphone transmitters or pocket transmitters are available at option, e.g. TXS-821HT, TXS-820HSE, TXS-820LT, TXS-820SX.

**TXA-480**

Order No. 17.2370

Wireless amplifier system

- Portable PA system, for mobile applications, e.g. at sales events, lectures
- Consisting of an amplifier/receiver unit, a wireless hand-held microphone and a practical shoulder bag
- 2 microphone inputs, 1 line input for CD player or cassette recorder
- Each input with gain control
- Universal power supply of the amplifier/receiver via 230V mains voltage, 12V car battery or 1.5V batteries D size
- Integrated charging feature for rechargeable batteries (1 x 9V battery, 2 x 1.5V battery AA size)
- M8 threaded jack for mounting onto a stand

Supplied without batteries.

Licence-free in the EU.

Model	TXA-480
Output power	20W <sub>MAX</sub>
Carrier frequency	863.05-864.95MHz
Operating range	approx. 30m
Mic input	2.5mV
Aux input	130mV
Record output	280mV/100kΩ
Equalizer	
Bass	±4dB/200Hz
Treble	±5dB/10kHz
Power supply	
Amplifier	230V~/50Hz/40VA, 12-15V~/1A, 8 x 1.5V batt. D size
Microphone	2 x 1.5V batt. AA size
Admiss. ambient temp.	0-40 °C
Dimensions	220x275x140mm
Weight	3.3kg
<b>Inputs</b>	
Mic	2 x 6.3mm jack
Aux	1 x 6.3mm jack
<b>Outputs</b>	
Record	1 x 6.3mm jack



**M-32CD**

Order No. 17.3350



CD player module, with anti-shock system and MP3 reproduction.

- Slot-in mechanism
- USB connection for external storage media
- Random play, repeat function
- Track programming

- Supplied with remote control
- Power supply: 12V~/800mA
- Dimensions: 174x52x160mm
- Mounting cutout: 155x50x150mm
- Audio CD/CD-R/CD-RW/MP3 CD



### PAS-250

Order No. 17.2730



**Portable amplifier system**, suitable for processions and other mobile applications.

- Very comfortable to wear and great mobility due to rucksack method
- 2 horn speakers for a powerful reproduction
- Integrated wireless receiver
- Built-in rechargeable lead gel battery 12V/7.2Ah (operating time: up to 8 hours)
- Integrated automatic charging of rechargeable battery
- Charge socket for supplied 12V PSU
- 2 inputs (channels 1+2) via comb. jacks mic (XLR)/line (6.3mm), each with gain control
- 2 stereo line inputs (channels 3+4) via RCA jacks, gain control
- Limiter function
- 6.3mm connection for external speaker
- Nylon rucksack with storage pockets

**Licence-free in the EU.**

Matching microphone transmitters or pocket transmitters are available at option, e.g. TXS-821HT, TXS-820HSE, TXS-820LT or TXS-820SX.

Model	PAS-250
Output power	50W <sub>MAX</sub> /35W <sub>RMS</sub>
Frequency range	350-12,000Hz
Carrier frequency	863.05MHz
Operating range	approx. 30m
Sensitivities	
Mic inputs	1mV
Line inputs	150mV
Mix output	-
Equalizer	-
Power supply	rech. batt. 12V/7.2Ah
Admiss. ambient temp.	0-40 °C
Dimensions	total length: 130cm
Weight	7.7kg

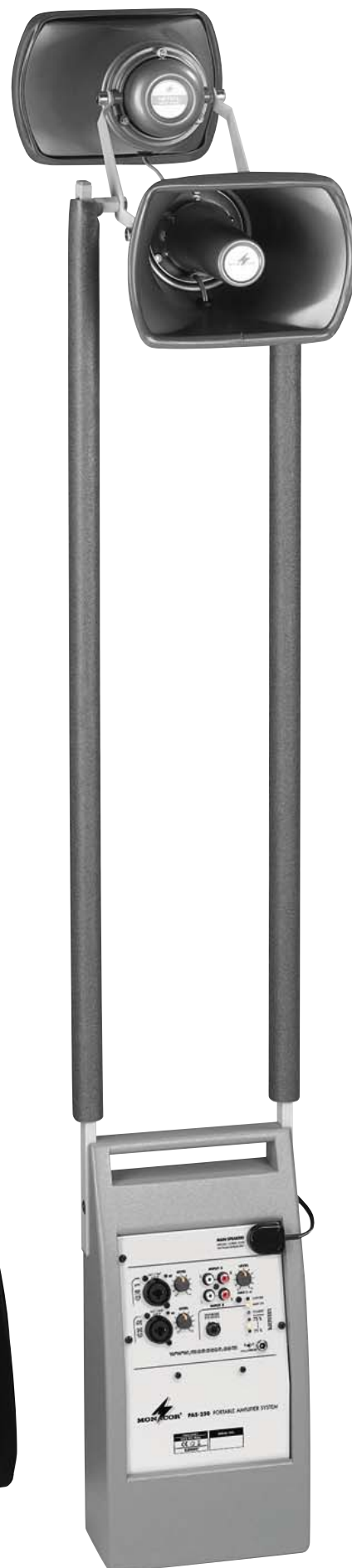

**TXA-120**

Order No. 17.2430

**Portable amplifier system**, with integrated adjustable 2-channel multifrequency receiver unit with UHF PLL technology.

- For mobile applications, e.g. guided tours, processions
- Robust plastic housing of compact size with carrying handle and carrying strap
- Extra low weight due to built-in rechargeable lithium-ion battery 14.8V/2.4Ah (operating time: up to 2 hours)
- Operation via rechargeable battery or supplied switch-mode PSU
- Integrated automatic charging of rechargeable battery
- 2 wireless microphone channels, each with 16 selectable UHF frequencies (863.05-864.925MHz) and volume control
- 1 microphone input via 6.3mm mono jack, 1 line input via 3.5mm mono jack, common volume control and tone control
- 1 mix output via 3.5mm mono jack

- 9mm ( $\frac{3}{8}$ " ) stand thread, can be mounted onto a speaker stand with standard diameter with stand adapter EBH-48 (available at option)
  - Supplied with practical protective shoulder bag which can stay on during operation
- Licence-free in the EU.**

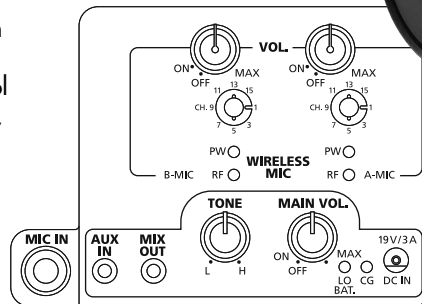

Matching microphone transmitters or pocket transmitters TXA-100HT or TXA-100HSE are available at option.

**TXA-110**

Order No. 17.2420

**Portable amplifier system**, with integrated adjustable multifrequency receiver unit with UHF PLL technology.

- For mobile applications, e.g. at sales events, lectures
- Robust plastic housing of compact size with carrying handle and carrying strap
- Operation via built-in rechargeable lead gel battery 12V/2.7Ah (operating time: up to 3 hours) or supplied switch-mode PSU
- Integrated automatic charging of rechargeable battery
- 1 wireless microphone channel with 16 selectable UHF frequencies (863.05-864.925MHz) and volume control
- 1 microphone input via 6.3mm mono jack, 1 line input via 3.5mm mono jack, common volume control and tone control
- 1 mix output via 3.5mm mono jack
- 9mm ( $\frac{3}{8}$ " ) stand thread, can be mounted onto a speaker stand with standard diameter with stand adapter EBH-48 (available at option)

- Supplied with practical protective shoulder bag which can stay on during operation
- Licence-free in the EU.**

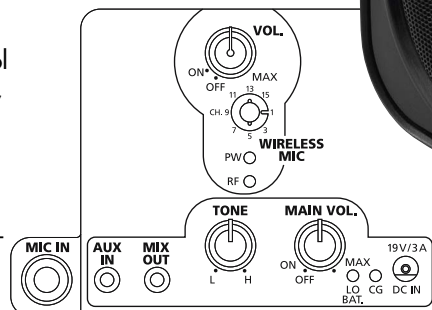

Model	TXA-120	TXA-110
Output power	50W <sub>MAX</sub> /36W <sub>RMS</sub>	50W <sub>MAX</sub> /36W <sub>RMS</sub>
Frequency range	60-15,000Hz	60-15,000Hz
Carrier frequency	863.05-864.925MHz	863.05-864.925MHz
Operating range	approx. 30m	approx. 30m
Sensitivities		
Mic inputs	10mV	10mV
Line inputs	100mV	100mV
Mix output	560mV	560mV
Equalizer	±8dB/10kHz	±8dB/10kHz
Power supply	rech. batt. 14.8V/2.4Ah, 19V=2.6A via suppl. PSU	rech. batt. 12V/2.7Ah, 19V=2.6A via suppl. PSU
Admiss. ambient temp.	0-40 °C	0-40 °C
Dimensions	160x210x290mm	160x210x290mm
Weight	3.2kg	4.2kg

### TXA-100HT

Order No. 17.2450

**Hand-held microphone with integrated multifrequency transmitter**, with UHF PLL technology. Matching the portable amplifier systems TXA-110 and TXA-120.

- Dynamic microphone cartridge, cardioid characteristic
- 16 selectable UHF frequencies (863.05-864.925MHz)
- Battery status indication
- Transmitting power: < 10mW (EIRP)
- Power supply via 2 x 1.5V battery AA size (not supplied)

**Licence-free in the EU.**



### TXA-100HSE

Order No. 17.2440

**Multifrequency pocket transmitter**, with UHF PLL technology. Matching the portable amplifier systems TXA-110 and TXA-120.

- 1 headband microphone (omnidirectional characteristic), 1 tie clip microphone (cardioid characteristic)
- 16 selectable UHF frequencies (863.05-864.925MHz)
- Battery status indication
- Transmitting power: < 10mW (EIRP)
- Power supply via 2 x 1.5V battery AA size (not supplied)
- Belt clip

**Licence-free in the EU.**



Model	TXA-100HT	TXA-100HSE
Carrier frequency	863.05-864.925MHz	863.05-864.925MHz
Audio frequency range	50-18,000Hz	50-18,000Hz
Frequency stability	±0.005%	±0.005%
Dimensions	∅ 50mm x 255mm	65x100x35mm
Weight	290g	320g

### TXA-100MC

Order No. 17.2470

**Helix microphone cable**, suitable for portable amplifier systems TXA-110 and TXA-120 or similar applications.

- Black version
- Extendible from 0.6m to 1.6m
- Fitted with 1 x XLR inline jack and 1 x 6.3mm right-angle mono plug



### EBH-48

Order No. 11.1130

**Stand adapter**

- For mounting the portable amplifier systems TXA-100SET, TXA-110, TXA-120 and other units with 9mm (3/8") inside thread onto a stand
- Black lacquered steel version
- 9mm thread (3/8") x 15mm threaded bolt
- Load capacity: 7.5kg max.

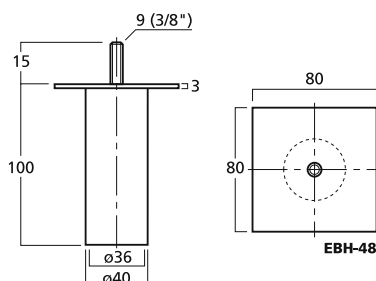

The wireless infrared transmission system IRS-200 allows for a parallel operation of several systems in different rooms, eg. in schools or conference centres. Unlike with standard wireless systems, no interference caused by frequency overlaps will occur here. Visual contact of transmitter and receiver is required for the transmission.

The components of the infrared transmission system are licence-free, irrespective of changes to the frequency assignments.

**IRS-200TXA**

Order No. 17.3250

Portable amplifier system, with integrated 2-channel infrared receiver unit.

- Infrared receiver with 2 wireless microphone channels (2.3MHz/2.8MHz), volume can be adjusted for each channel
- Large infrared detection angle
- Ideally suited for the use in schools, at conferences and lectures

Model	IRS-200TXA
Output power	45W <sub>MAX</sub> /30W <sub>RMS</sub>
Carrier frequency	2.3MHz (channel A) 2.8MHz (channel B)
Wavelength	850nm
Operating range	approx. 15m
Sensitivity	
Mic inputs	10mV
Line inputs	300mV
Mix output	1V
Equalizer bass	0-10dB/100Hz
Equalizer, treble	0-10dB/10kHz
Power supply	rech. batt. 12V/2.9Ah, 18V=2.7A via suppl. PSU
Admiss. ambient temp.	0-40 °C
Dimensions	190x320x195mm
Weight	4.3kg

- Operation via built-in rechargeable lead gel battery 12V/2.9Ah (operating time: up to 3 hours) or supplied switch-mode PSU
- Integrated automatic charging of rechargeable batteries with visual charging indicator
- 1 adjustable microphone input via 6.3mm mono jack, 1 adjustable line input via 3.5mm stereo jack, common tone control
- 1 mix output via 3.5mm stereo jack
- 2 F-standard jacks for connecting infrared sensors IRS-200IR, available at option
- 16mm stand thread for wall bracket IRS-200PAST, available at option

Matching microphone transmitters, e.g. IRS-200HT or IRS-202HT and further accessories are available at option.

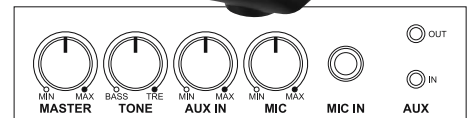

**IRS-200HT**

Order No. 17.3290

Hand-held microphone with integrated infrared transmitter, channel A, matching the 2-channel infrared receivers IRS-200TXA, IRS-200AMP and IRS-200R.

- Condenser microphone cartridge, cardioid characteristic
- Mute function
- Adjustable transmitting power (high/low)
- 3.5mm jack input for connecting an optional tie clip microphone/headband microphone or a line source, e.g. MP3 player
- Power supply via 2 x 1.5V battery AA size or NiMH rechargeable battery (not supplied)
- Integrated charging contacts for directly charging the batteries via charging station IRS-200PS

Licence-free in the EU.

Model	IRS-200HT	IRS-202HT
Carrier frequency	2.3MHz	2.8MHz
Wavelength	850nm	850nm
Operating range	approx. 15m	approx. 15m
Audio freq. range	50-15,000Hz	50-15,000Hz
Operating time	> 8h	> 8h
Line input	200mV	200mV
Dimensions	ø 36mm x 200mm	ø 36mm x 200mm
Weight	100g	100g

**IRS-202HT**

Order No. 17.3300

Hand-held microphone with integrated infrared transmitter, channel B, matching the 2-channel infrared receivers IRS-200TXA, IRS-200AMP and IRS-200R.

- Condenser microphone cartridge, cardioid characteristic
- Mute function
- Adjustable transmitting power (high/low)
- 3.5mm jack for connecting an optional tie clip microphone/headband microphone or a line source, e.g. MP3 player
- Power supply via 2 x 1.5V battery AA size or NiMH rechargeable battery (not supplied)
- Integrated charging contacts for directly charging the batteries via charging station IRS-200PS

Licence-free in the EU.

Matching charging station IRS-200PS and carrying strap IRS-200H are available at option.

**IRS-200R**

Order No. 17.3340

2-channel infrared receiver unit, with line output.

- Infrared receiver with 2 wireless microphone channels (2.3MHz/2.8MHz), volume can be adjusted for each channel
- 1 line output via 6.3mm jack, switchable low/high
- 2 F-standard jacks for connecting infrared sensors IRS-200IR, available at option
- The infrared sensor IRS-200IR (available at option) is required for operation

Model	IRS-200R
Carrier frequency	2.3MHz (channel A) 2.8MHz (channel B)
Wavelength	850nm
Operating range	approx. 15m
Line output	1V/100mV
Frequency range	70-10,000Hz
Power supply	12V=1A via suppl. PSU
Admiss. ambient temp.	0-40 °C
Dimensions	118x50x210mm
Weight	750g
Connections	6.3mm jack

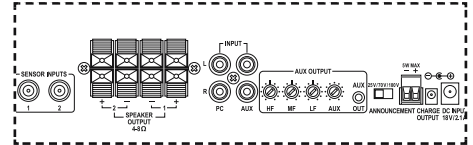

### IRS-200AMP

Order No. 17.3260

**Mono mixing amplifier**, with integrated 2-channel infrared receiver unit.

- Infrared receiver with 2 wireless microphone channels (2.3MHz/2.8MHz), volume can be adjusted for each channel
- Large infrared detection angle
- 2 adjustable line inputs via stereo RCA jacks, with recessed common 2-way tone control
- PA announcement input (25V/70V/100V) with priority, connection via screw terminal
- Aux output via 3.5mm stereo jack, with adjustable 3-way equalizer
- 2 F-standard jacks for connecting infrared sensors IRS-200IR, available at option
- Connection for power supply via external charging station IRS-200PS
- Protected against short circuit and excess temperature

Model	IRS-200AMP
Output power	40W <sub>MAX</sub> /30W <sub>RM</sub> /4Ω
Carrier frequency	2.3MHz (channel A) 2.8MHz (channel B)
Wavelength	850nm
Operating range	approx. 15m
Sensitivities	
Aux input	300mV
PC input	300mV
Aux output	1V
Frequency range	20-20,000Hz
Equalizer bass	±10dB/100Hz (master, aux output)
Equalizer midrange	±10dB/1kHz (aux output)
Equalizer treble	±10dB/10kHz (master, aux output)
S/N ratio	80dB
THD	0.1%
Power supply	18V±/2.1A via suppl. PSU
Admiss. ambient temp.	0-40 °C
Dimensions	266x66x230mm
Weight	2kg
<b>Inputs</b>	2 x RCA L/R (PC, aux) 1 x screw terminal
<b>Outputs</b>	4 x spring-load. speaker term. L/R 1 x 3.5mm stereo jack



### IRS-200IR

Order No. 17.3310

**Infrared sensor**, for increasing the operating range.

- Suitable for the amplifiers/receivers IRS-200AMP, IRS-200R and IRS-200TXA
- Detection angle: 150° (hor.) x 80° (vert.)
- Operating range: approx. 15m
- Power supply via IRS-200AMP, IRS-200R or IRS-200TXA
- Metal housing with movable mounting bracket for wall mounting or ceiling suspension
- Including 10m connection cable with F-standard plugs
- Dimensions: 90x40x90mm
- Weight: 250g

### IRS-200PS

Order No. 17.3330



**Intelligent PWM quick charging station**, for simultaneously charging the rechargeable batteries (NiMH) of two hand-held microphones IR-200HT, IRS-202HT or ATS-12HT.

- Average charging time, depending on capacity and condition of the rechargeable batteries used: approx. 6-8 hours, e.g. for 2,500mAh rech. batteries
- Microprocessor-controlled charging control for each slot (-ΔV control and timer-controlled)
- LED for indicating charging status and malfunction for each slot
- Supplied with plug-in PSU
- Dimensions: 120x57x120mm
- Weight: 455g

### IRS-200BAG

Order No. 17.3270

**Transport and protective bag**, suitable for the portable amplifier system IRS-200TXA.

- Robust synthetic fibre material, black
  - Sound-transparent front of meshed fabric
  - The bag can stay on during operation!
  - 2 lateral pockets with hook and loop fastener
  - Adjustable carrying strap
- Supplied without unit.**



### IRS-200PAST

Order No. 17.3320

**Wall bracket for IRS-200TXA**  
Black lacquered metal version. With 16mm stand thread for mounting IRS-200TXA.

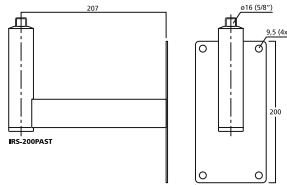

### IRS-200H

Order No. 17.3280

**Carrying strap**, matching the hand-held microphone IRS-200HT, IRS-202HT or ATS-12HT.

- Adjustable strap length
  - With additional removable belt clip
- Supplied without hand-held microphone.**



The SPEECH-500 is equipped with innovative technology and thus the professional solution for voice and music transmissions of high requirements. The lectern features a variable electric height adjustment. A laptop can space-savingsly be inserted underneath the transparent glass plate on the top part of the lectern in a 2-step illuminated compartment which has especially been designed for this purpose. The built-in audio system as well as the UHF PLL wireless technology with transmitter module and receiver module perfectly meet every requirement. In audio link operation, this allows for a wireless control of further active speaker systems which are equipped with respective wireless receivers, e.g. TXA-800 and TXA-1000 series.

## SPEECH-500

Order No. 17.3400

### Professional lectern with electric height adjustment and integrated wireless amplifier system

- Built-in 4-channel mixing amplifier with limiter, 100W<sub>MAX</sub>, 50W<sub>RMS</sub>
- Variable electric height adjustment of the lectern, 85-125cm
- Top part of the lectern with a transparent safety glass plate and illuminated compartment for a laptop
- Built-in UHF PLL receiver (TXA-802MR) with 16 selectable frequencies (863.1-864.9MHz) with diversity system, matching transmitters are available at option, e.g. TXA-800HSE or TXA-800HT
- Built-in UHF PLL transmitter (TXA-802MT) with 16 selectable frequencies (863.1-864.9MHz) for setting up audio link transmission
- 3 inputs via comb. jack mic (XLR)/line (6.3mm jack), stereo line input (RCA), gain controls, 3-way equalizer for the comb. inputs
- 2 XLR jacks on the top part of the lectern for 2 optional gooseneck microphones (each one uses a microphone input), matching microphone EMG-650P is available at option
- Additional XLR jack for LED gooseneck light (e.g. GNL-304, available at option)
- 12V phantom power for mic input 1 and 2
- 1 stereo line output via RCA jacks
- 30cm (12") full range speaker of high power capability providing a powerful sound
- High-quality wooden cabinet in a wood and lacquer combination
- Standard wood decor: Red Oak
- Holder for name of speaker to be mounted with terminal screw
- 3 additional storage compartments for documents and other utensils
- 2 swivel castors with brakes, 2 fixed castors

Licence-free in the EU.

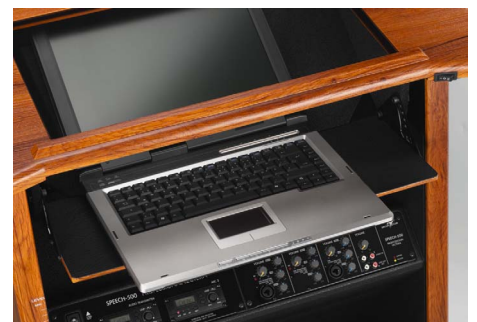
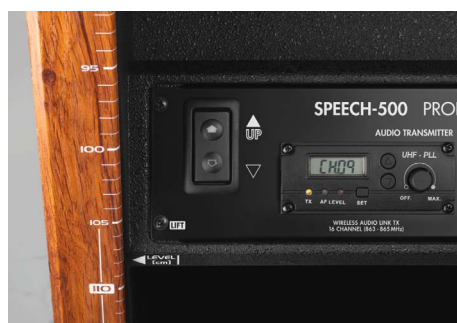

(Supplied w/o laptop)

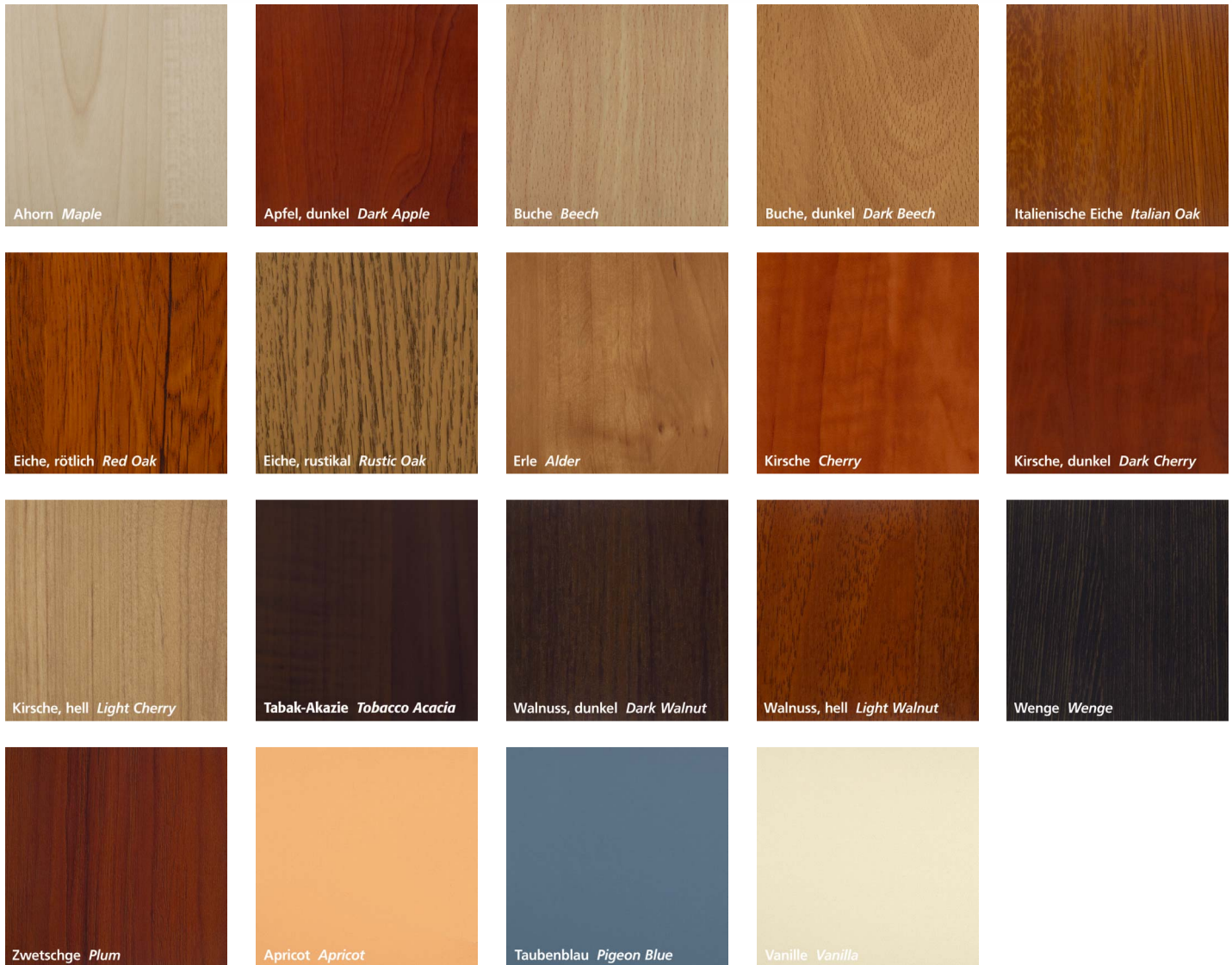

Beside the standard wood decor Red Oak, you can choose your individual colour or desired wood decor from 18 other design options:

Maple, Dark Apple, Beech, Dark Beech, Italian Oak, Red Oak (standard), Rustic Oak, Alder, Cherry, Dark Cherry, Light Cherry, Tobacco Acacia, Dark Walnut, Light Walnut, Wenge, Plum, Apricot, Pigeon Blue, Vanilla.

Delivery times and extra charges on request.

Model	SPEECH-500
Output power	100W <sub>MAX</sub> /50W <sub>RMS</sub>
Carrier frequency	863.1-864.9MHz
Operating range	30m max.
Frequency range	50-20,000Hz
Sensitivities	mic1: 2mV mic2-3: 4.5mV line1-3: 150mV (6.3mm jack) line: 400mV (RCA)
Outputs	line: 320mV (RCA)
Equalizer	bass: ±12dB/60Hz mid: ±7dB/1kHz treble: ±12dB/15kHz
Power supply	230V~/50Hz/135VA
Admiss. ambient temp.	0-40 °C
Dimensions	800x1,250x570mm
Weight	45kg



The SPEECH-200: even more powerful, with more features and easier to transport due to integrated castors. Set it up, connect the power supply - ready to use!

**SPEECH-200**

Order No. 17.3160

**Professional lectern with integrated wireless amplifier system**

- Built-in, powerful mixing amplifier and speaker system, 75W<sub>RMS</sub>
- Integrated limiter
- 3 inputs via comb. jack mic (XLR)/line (6.3mm jack), each with 3-way equalizer and gain control
- 1 stereo line input via RCA jacks with gain control
- 2 XLR jacks on the top part of the lectern for 2 optional gooseneck microphones (each one uses a microphone input), with phantom power
- 1 stereo line output via RCA jacks
- 2-way speaker system
- Integrated light in the top part of the lectern
- High-quality, two-coloured wooden cabinet
- Column with 2 document compartments and 2 storage compartments
- 2 castors

Licence-free in the EU.

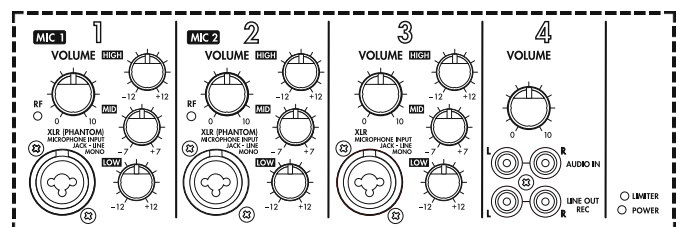

Model	SPEECH-200
Output power	100W <sub>MAX</sub> /75W <sub>RMS</sub>
Carrier frequency	863.05MHz
Operating range	25m max.
Frequency range	60-20,000Hz
Sensitivities	mic1: 15mV mic2-3: 5mV line1-3: 220mV (6.3mm jack) line: 250mV (RCA)
Outputs	line: 390mV (RCA)
Equalizer	bass: ±12dB/60Hz mid: ±7dB/1kHz treble: ±12dB/15kHz
Power supply	230V~/50Hz/180VA
Admiss. ambient temp.	0-40 °C
Dimensions	540x1,140x430mm
Weight	33kg

Supplied without gooseneck microphone. Matching microphone EMG-650P is available at option.

Matching microphone transmitters or pocket transmitters are available at option, e.g. TXS-821HT, TXS-820HSE, TXS-820LT or TXS-820SX.



An innovative and high-quality solution for PA speech and music applications of high requirements:

The SPEECH-100 active lectern from MONACOR perfectly combines sound quality, volume capability and convenience. It is rechargeable battery-operated and thus perfectly mobile. The SPEECH-100 turns any area of PA application into an auditorium all by itself. It can also perfectly be integrated into any given surroundings, whenever a temporary or permanent talking point is required.

The integrated amplifier and the speaker technology not only allow for voice transmissions, but can also easily be used for music reproductions and e.g. dubbings of films or presentations with quite good results. Simply plug-in a gooseneck microphone and/or connect a signal source - switch on - ready to use.

### SPEECH-100

Order No. 17.2880

863.05  
MHz

#### Professional lectern with integrated wireless amplifier system

- Built-in mixing amplifier and speaker system, 36W<sub>RMS</sub>
- Operation via built-in rechargeable lead gel batteries: 2 x 12V/7Ah (operating time: up to 16 hours)
- Integrated charging feature for rechargeable batteries, supplied with charger
- 2 inputs via comb. jack mic (XLR)/line (6.3mm jack)
- 1 stereo line input via RCA jacks
- Each input with gain control
- 2 XLR jacks on the top part of the lectern for 2 optional gooseneck microphones (each one uses a microphone input) or one microphone and one LED gooseneck light, available at option
- 12V phantom power
- 1 stereo line output via RCA jacks
- 6.3mm jack connection (8Ω) for external speaker
- 2-way speaker system
- High-quality wooden cabinet with replaceable black or wood coloured bottom plates
- Top part of the lectern with folding document compartment

Licence-free in the EU.

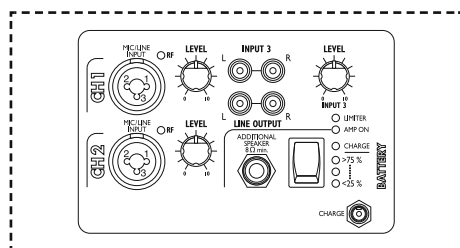

Model	SPEECH-100
Output power	50W <sub>MAX</sub> /36W <sub>RMS</sub>
Carrier frequency	863.05MHz
Operating range	25m max.
Frequency range	70-20,000Hz
Sensitivities	mic: 8mV line: 60mV (6.3mm jack) line: 400mV (RCA)
Outputs	line: 650mV (RCA)
Equalizer	-
Power supply	rech. batt. 2 x 12V/7Ah, 12V≈/1.5A via suppl. charger
Admiss. ambient temp.	0-40 °C
Dimensions	525x1,120x440mm
Weight	29kg

Supplied without gooseneck microphone and without gooseneck light. Matching microphone EMG-650P and matching LED gooseneck light GNL-304 are available at option.

Matching microphone transmitters or pocket transmitters are available at option, e.g. TXS-821HT, TXS-820HSE, TXS-820LT or TXS-820SX.

#### PROSOUND 04/2009

"An extraordinary unit which fully meets every requirement. For the benefit of the customers, such a lectern should be included in the product range of each audio supplier."

#### AV-views 03/2009

"Lectern of an appealing design. With the power capability, it will certainly be suitable for PA applications in larger rooms."

**ETS-840TXS**

Order No. 17.2400

863.05  
MHz**Lectern with integrated wireless amplifier system**

- Built-in mixing amplifier and speaker system, 60W<sub>RMS</sub>
- 1 cable-connected input channel via comb. jack mic (6.3mm)/line (XLR)
- 1 aux input channel via RCA jack L/R, switchable aux/tape/tuner/CD
- Controls for input level, tone and output level
- Record output via 6.3mm jack
- Output for external speaker via spring-loaded terminal
- Supplied with hand-held transmitter, gooseneck microphone and gooseneck light

**Licence-free in the EU.**

Matching pocket transmitters TXS-820HSE, TXS-820LT or TXS-820SX are available at option.

Model	ETS-840TXS
Output power	90W <sub>MAX</sub> /60W <sub>RMS</sub>
Carrier frequency	863.05MHz
Operating range	25m max.
Frequency range	60-17,000Hz
Sensitivities	mic1: 2mV mic2: 1mV line: 120mV aux1: 100mV aux2: 200mV aux3: 300mV aux4: 800mV
Outputs	1.2V (record out) 760mV (line out)
Equalizer	bass: ±10dB/100Hz treble: ±10dB/10kHz
Power supply	230V~/50Hz/135VA
Admiss. ambient temp.	0-40 °C
Dimensions	580x1,140x420mm
Weight	17.5kg

The control unit CS-50CU, the microphone station for the chairperson CS-50CH and the microphone station for conference delegates CS-50DU together form a conference discussion system with extensive configuration facilities for maximum flexibility.

### CS-50CU

Order No. 17.3420

## NEW.

#### Control unit

The control centre of the conference discussion system. The CS-50CU allows to set up a system with up to 50 microphone stations and at the same time supplies their operating voltage.

- Adjustable discussion modes (e.g. number of simultaneous speakers, speaking time limits, sole activation for the chairperson)
- Built-in speaker and connection for optional headphones
- Keypad lock
- Date and time indication via LCD
- Stopwatch
- Test function for connected microphone stations
- Connection facilities for optional units, e.g. external microphone, telephone coupler, signal processing units (e.g. equalizer), recorders, amplifiers, audio line sources



Matching microphone stations:  
CS-50DU and CS-50CH.

Model	CS-50CU
Connections	2 x RCA (input/output for telephone coupler) 2 x RCA (input/output, e.g. for equalizer) 2 x RCA L/R (input/output for recorder) 2 x RCA (input/output for line signals) 1 x XLR (microphone input) 2 x 7-pole DIN jack (connection for microphone stations)
Power supply	100-240V~/50-60Hz/90VA
Dimensions	360x90x150mm
Weight	1.7kg

Matching control unit: CS-50CU.



Matching control unit: CS-50CU.



### CS-50CH

Order No. 17.3410

## NEW.

#### Microphone station for the chairperson

- Back electret cartridge of cardioid characteristic optimised for voice transmissions
- Built-in speaker and connection for optional headphones
- Convenient operation due to large function button
- Status displays on the microphone and desktop station
- Priority button with chime

### CS-50DU

Order No. 17.3430

## NEW.

#### Microphone station for the conference delegates

- Back electret cartridge of cardioid characteristic optimised for voice transmissions
- Built-in speaker and connection for optional headphones
- Convenient operation due to large function button
- Status displays on the microphone and desktop station

Model	CS-50CH	CS-50DU
System	back electret/cardioid	back electret/cardioid
Frequency range	50-18,000Hz	50-18,000Hz
Connections	2 x 3.5mm jack 1 x 2m connection cable with 7-pole DIN plug 1 x 7-pole DIN jack	1 x 3.5mm jack 1 x 2m connection cable with 7-pole DIN plug 1 x 7-pole DIN jack
Power supply	via control unit CS-50CU	via control unit CS-50CU
Dimensions	115x65x170mm (console housing)	115x65x170mm (console housing)
Gooseneck length	400mm	400mm
Weight	1.1kg	1.1kg

**Professional 16-channel Mono PLL Audio Transmission System, 863-865MHz, with Extensive Accessories**

- Suitable as a tour guide system and for any other application in which a certain audio source or voice source is to be distributed to one or more receivers
- Wireless transmissions of audio signals with one transmitter and one receiver are also possible
- Simultaneous operation of up to 8 transmitters with different frequencies (dep. on distance of transmitter, stationary RF sources of interference and other local conditions)
- Licence-free in the EU



**ATS-16R**

Order No. 24.4680

**16-channel PLL receiver**

- Built-in speaker
- Including matching earpiece with rubber earband
- Connection for optional audio tube earphone ET-16
- Audio output via 3.5mm stereo jack
- Pilot tone squelch and noise squelch
- Status indication of rech. battery, indication of carrier signal
- Volume level control, belt clip
- Power supply via 2 x 1.2V NiMH rech. battery AA size (not supplied) or low-voltage jack (5V), dimensions: 66x111x35mm, weight: 100g

**ATS-16T**

Order No. 24.4690

**16-channel PLL transmitter, for microphone operation and line audio signals.**

- Integrated microphone
- Supplied with additional electret tie clip microphone
- Audio line input via 3.5mm mono jack
- Status indication of rech. battery, indication of carrier signal
- Volume level control, belt clip
- Power supply via 2 x 1.2V NiMH rech. battery AA size (not supplied) or low-voltage jack (5V), transmitting power: ≤ 10mW (EIRP), operating range: 50m min., dimensions: 66x111x35mm, weight: 85g

**Licence-free in the EU!**

**ATS-16BAG**

Order No. 22.0720

**Artificial leather protective bag, for the transmitters and receivers of the ATS-16 series. With belt clip and hook and loop fastener.**



**ATS-16CORD**

Order No. 22.0730

**Lanyard, for the transmitters and receivers of the ATS-16 series. Nylon version.**

**PROSOUND 03/2007** on the ATS-16R and components of the tour guide system "An extensive system which is equipped for every eventuality. Easily set up with perfect audibility! A functional state-of-the-art system with perfect features for practical operations."

The hand-held microphone with integrated transmitter ATS-12HT matches the ATS-16 series and is available at option.



**ATS-16PS**

Order No. 24.4670

**Intelligent PMW quick charging station, for simultaneously charging the rechargeable batteries (NC, NiMH) of two units of the ATS-16 series.**

- Average charging time, depending on capacity and condition of the rechargeable batteries used: approx. 3-4 hours, e.g. for 1,300mAh rech. batteries
- LED indication for charging and fault indication for each slot
- Mechanical reverse polarity protection
- Supplied with plug-in PSU



**ATS-36C**

Order No. 24.4700

**Transport case with intelligent PWM quick charging feature, for the transmitters and receivers of the ATS-16... series.**

- For simultaneously charging the rech. batteries (NC, NiMH) of up to 36 units
- Average charging time, depending on capacity and condition of the rechargeable batteries used: approx. 5-6 hours, e.g. for 1,300mAh rech. batteries
- LED indication for charging and fault indication for each slot
- Mechanical reverse polarity protection
- Lockable plastic transport case fitted with castors
- Supplied with matching switch-mode PSU
- Dimensions: 860x230x350mm



### ES-16

Order No. 22.0740

#### Mono earphone

- Suitable for the receivers of the ATS-16 or ATS-10 series
- Flexible rubber earband for a secure fit to the ear
- Dynamic 32Ω system
- 1.2m connection cable with gold-plated 3.5mm stereo plug

Model	ES-16
System	dynamic
Frequency range	20-20,000Hz
Impedance	32Ω
Max. input power	50mW
Sensitivity	105dB/1mW
Cable	1.2m
Plug	3.5mm stereo plug
Adapter	
Weight w/o cable	8g

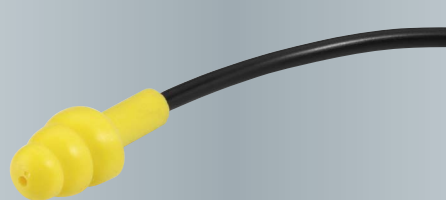

### ET-16

Order No. 22.0750

#### Audio tube earphone

- Suitable for receiver ATS-16R
- The audio signal which is created by the integrated speaker of the ATS-16R is transmitted directly to the ear via the flexible tube. An easy-to-clean silicone ear tip ensures a secure fit in the ear
- Tube length: 1m



### ECM-16N

Order No. 23.4340

#### Electret neckband microphone

A special microphone, very comfortable to wear due to its ergonomic design. The unusual combination of gooseneck and microphone ensures a secure fit and a good voice transmission. Perfectly matched to the transmitter ATS-16T.

- Can also be operated without ATS system via power supply adapter (e.g. EMA-20), available at option
- Flexible 48cm neckband of high-quality metal gooseneck technology
- Cardioid characteristic with low acoustic feedback and a voice-optimised sound
- 1.1 m connection cable with 3.5mm mono plug
- Supplied with foam windshield

Model	ECM-16N
System	electret/cardioid
Frequency range	150-16,000Hz
Impedance	680Ω
Sensitivity	3.16mV/Pa/1kHz
Max. SPL	110dB
Power supply	1.5V via ATS-16T or 1.5-9V via optional power supply adapter
Admiss. ambient temp.	0-40 °C
Weight	160g
Connection	3.5mm mono plug

### G-7SET

Order No. 25.0760



#### Pair of dual-band transceivers, case set.

- 8 PMR channels 446MHz
- 69 LPD channels 433MHz
- Backlit LCD
- Vibracall function
- Key lock
- Manual transmit mode (PTT) or voice-controlled transmit mode for hands-free use (VOX)
- Monitor function
- Automatic squelch
- Channel scan mode
- CTCSS tones
- Dual watch
- Operating range: 5km max.
- Supplied with charger for 2 transceivers, 2 rechargeable battery packs, 2 clip microphones with earphones and 2 belt clips
- Supplied in a robust hard-sided case

Licence-free, please refer to the instruction manual on the website [www.monacor.com](http://www.monacor.com).

Model	G-7SET
Frequency range	446.00625-446.09375MHz (PMR) 433.075-434.775MHz (LPD)
Transmitting power	500mW (ERP)
Operating range	5km max.
Power supply	via integrated rech. NiMH battery 800mAh
Admiss. ambient temp.	-20 °C to +55 °C
Dimensions	58x195x34mm
Weight	190g
Connections	
Microphone	2.5mm jack
Speakers	3.5mm jack



## 16-channel Mono PLL Audio Transmission System, 863-865MHz

- Suitable as a tour guide system and for any other application in which a certain audio source or voice source is to be distributed to one or more receivers
- Wireless transmissions of audio signals with one transmitter and one receiver are also possible
- Due to the small frequency spacing in this free frequency range, a simultaneous operation of not more than two transmitters is recommended
- Licence-free in the EU

### ATS-10R

Order No. 24.3500

**Receiver**, with 3.5mm mono jack.

- 16 selectable channels
- Built-in speaker
- Including matching earpiece with rubber earband
- Status indication of rech. battery

- Operating positions: on/stand-by/off
- Volume level control, belt clip
- Power supply via 2 x 1.2V NiMH rech. battery AA size (not supplied), dimensions: 92x65x25mm, weight: 80g



### ATS-10TM

Order No. 24.3510

**Transmitter**, for microphone applications.

- 16 selectable channels
- Integrated microphone
- Supplied with additional electret tie clip microphone
- Status indication of rech. battery

- Operating positions: on/stand-by/off
- Volume level control, belt clip
- Power supply via 2 x 1.2V NiMH rech. battery AA size (not supplied), transmitting power:  $\leq 10\text{mW}$  (EIRP), operating range: 50m min., dimensions: 92x65x25mm, weight: 78g

**Licence-free in the EU!**



### ATS-10TL

Order No. 24.3520

**Transmitter**, for line audio signals.

- 16 selectable channels
- Audio connection via 3.5mm mono jack
- Status indication of rech. battery
- Operating positions: on/stand-by/off

- Volume level control, belt clip
- Power supply via 2 x 1.2V NiMH rech. battery AA size (not supplied), transmitting power:  $\leq 10\text{mW}$  (EIRP), operating range: 50m min., dimensions: 92x65x25mm, weight: 78g

**Licence-free in the EU!**



### ATS-12HT

Order No. 25.3310

**Hand-held microphone with integrated transmitter**

- Matching the 16-channel mono PLL audio transmission system of the ATS-10 series
- Electret microphone cartridge, cardioid characteristic
- 16 selectable channels
- Features pilot tone and is thus suitable for the operation with ATS-16R
- Mute function

- Push-to-talk function
- Adjustable transmitting power (high:  $\leq 10\text{mW}$ /low:  $\leq 1\text{mW}$ )
- LCD for indicating channel and battery status
- Integrated charging contacts for charging directly via charging station IRS-200PS
- Power supply via 2 x 1.2V NiMH rech. battery AA size (not supplied), operating range: approx. 50m, dimensions:  $\varnothing 35\text{mm} \times 200\text{mm}$ , weight: 100g

**Licence-free in the EU.**

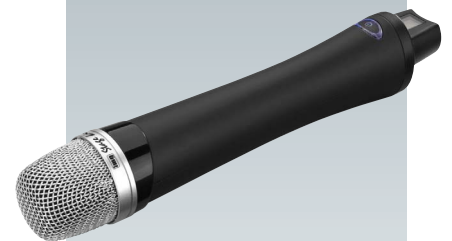

Matching charging station IRS-200PS and carrying strap/belt clip IRS-200H are available at option.

### ATS-10BAG

Order No. 23.3910

**Protective bag**, for the transmitters and receivers of the ATS-10 series. With belt clip.



### ATS-10PS

Order No. 24.3530

**Automatic quick charging station**, for simultaneously charging the rechargeable batteries of two units of the ATS-10 series.

- Average charging time, depending on capacity and condition of the rechargeable batteries used: approx. 3-4 hours, e.g. for 1,300mAh rech. batteries
- Operating LEDs for "charging" and "charging completed"
- Supplied with plug-in PSU

### ATS-12C

Order No. 24.3930

**Transport case with integrated charging function**, for the transmitters and receivers of the ATS-10 series.

- For simultaneously charging the rech. batteries of up to 12 units
- Charging indicator (LED) for each slot
- Wooden case with black artificial leather cover
- Supplied with matching PSU
- Dimensions: 300x170x280mm

**Supplied without units.**

### ATS-30C

Order No. 24.4320

**Transport case with integrated charging function**, for the transmitters and receivers of the ATS-10 series.

- For simultaneously charging the rech. batteries of up to 30 units
- Charging indicator (LED) for each slot
- Transport case with black artificial leather cover
- Supplied with matching PSU
- Dimensions: 660x170x300mm

**Supplied without units.**

### 40-channel Mono PLL Voice Transmission System, 863-865MHz

- Suitable as a tour guide system and for any other application in which a certain voice source is to be distributed to one or more receivers
- Due to the narrow-band frequency range which has been perfectly adapted to speech applications, a parallel operation of up to 10 different channels is possible without any interference
- Licence-free in the EU

### ATS-40R

Order No. 25.2320

**40-channel PLL receiver**

- Including matching earpiece with rubber earband
- Adjustable headphone output
- LCD for channel and battery status
- Switches off automatically after not receiving a signal for 30 minutes (energy-saving feature)
- Power supply via 2 x 1.2V NiMH rech. battery AA size (not supplied)
- Dimensions: 66x95x24mm
- Weight: 115g

### ATS-40T

Order No. 25.2330

**40-channel PLL transmitter**, for mic. applications.

- Integrated microphone
- Supplied with additional electret tie clip microphone
- LCD for channel and battery status
- Transmitting power:  $\leq 10\text{mW}$  (EIRP), operating range: 50m min.
- Switches off automatically after not receiving an input signal for 30 minutes (energy-saving feature)
- Power supply via 2 x 1.2V NiMH rech. battery AA size (not supplied)
- Dimensions: 66x95x24mm
- Weight: 120g

**Licence-free in the EU!**

Matching chargers TXA-800PS, TXA-12C or TXA-36C are available at option.





### A PA System for Conference Rooms

In larger hotels, conference rooms are frequently provided. It is required to adjust the volume in the individual rooms separately, with the option to switch off the background music and announcements of the PA system completely. This can be done at the amplifier itself which is equipped with 5 adjustable output groups.

In case of an alarm, e.g. fire, the announcements have to reach the switched-off areas as well. This is realised by the emergency pri-

ority function of the amplifier. If this function is activated, every output will be adjusted to max. volume.

The message module PA-1120DM can be built into the amplifier. Thus, a contact-controlled replay of individually recorded alarm messages is possible.

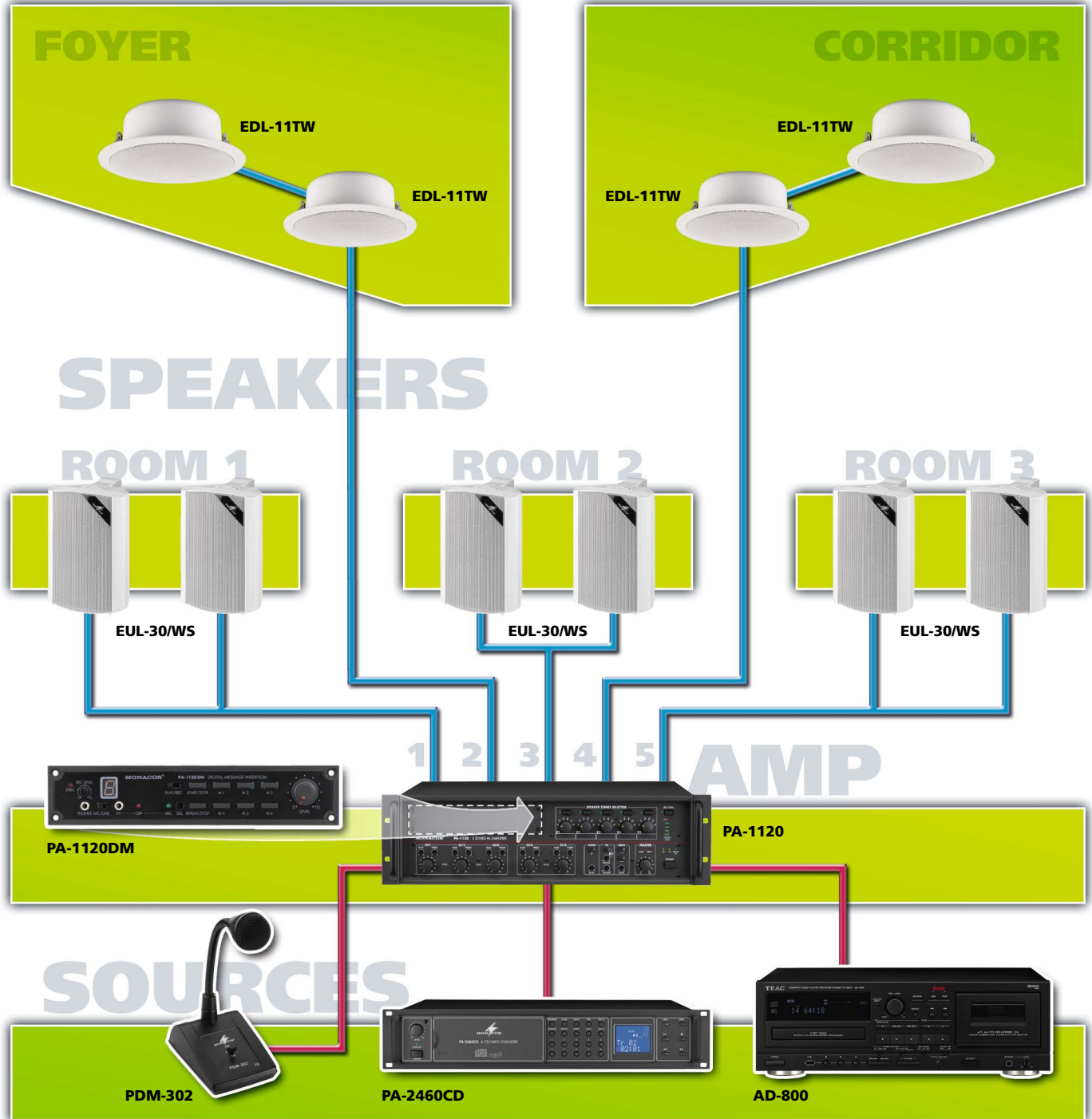

- List of materials**
- |               |                          |
|---------------|--------------------------|
| Units         |                          |
| 1 x PA-1120   | 5-zone amplifier         |
| 1 x PA-1120DM | message module           |
| 1 x PDM-302   | desktop microphone       |
| 1 x PA-2460CD | CD changer               |
| 1 x AD-800    | MP3 recorder + tape deck |

- Speakers**
- |               |                      |                    |
|---------------|----------------------|--------------------|
| 6 x EUL-30/WS | wall speakers        | 15 W each          |
| 4 x EDL-11TW  | ceiling installation | 5 W each           |
|               |                      | <b>Total</b> 110 W |

# KNOW-HOW: Flush-mount Ceiling Speakers

## List of PA flush-mount ceiling speakers, sorted by mounting dimensions

Item	Power rating	Connection	Outside Ø	Mounting Ø	Mounting depth	R	F
EDL-22	6 / 3 W	100 V	83 mm	73 mm	67 mm	K	K
EDL-33	6 / 3 / 1.5 W	100 V	105 mm	90 mm	110 mm	M	M
EDL-82/WS	6 / 3 / 1.5 W	100 V	100 mm	92 mm	96 mm	K	M
EDL-84/WS	6 / 3 W	100 V	103 mm	92 mm	80 mm	K	M
EDL-204	20 / 15 / 10 / 5 / 2.5 W	100 V	132 mm	104 mm	118 mm	K	K
EDL-35	6 / 3 / 1.5 W	100 V	135 mm	110 mm	110 mm	M	M
EDL-205	20 / 15 / 10 / 5 / 2.5 W	100 V	150 mm	115 mm	120 mm	K	K
EDL-150/WS	10 / 5 / 2.5 / 1.25 / 0.625 W	100 V	150 mm	120 mm	70 mm	M	M
EDL-206	20 / 15 / 10 / 5 / 2.5 W	100 V	180 mm	132 mm	130 mm	K	K
EDL-24	6 / 3 / 1.5 W	100 V	170 mm	142 mm	60 mm	K	M
EDL-25	6 / 3 / 1.5 W	100 V	205 mm	165 mm	60 mm	K	M
EDL-155	15 / 10 / 5 / 2.5 / 1.25 W	100 V	202 mm	165 mm	95 mm	K	K
EDL-605	6 / 3 W	100 V	200 mm	180 mm	50 mm	M	M
EDL-606	6 / 3 / 1.5 W	100 V	200 mm	180 mm	60 mm	M	M
EDL-612	12 / 6 / 3 W	100 V	200 mm	180 mm	60 mm	M	M
EDL-620	20 / 10 / 5 W	100 V	200 mm	180 mm	65 mm	M	M
EDL-156	15 / 10 / 5 / 2.5 / 1.25 W	100 V	226 mm	190 mm	85 mm	K	K
EDL-36TW	10 / 5 / 2.5 W	100 V	200 mm	190 mm	110 mm	M	M
EDL-26	10 / 5 / 2.5 / 1.25 W	100 V	230 mm	200 mm	75 mm	K	M
EDL-68/WS	6 / 3 W	100 V	220 mm	200 mm	65 mm	M	M
EDL-16TW	10 / 5 / 2.5 / 1.25 10 W / 8 ohms	100 V / 8 ohms	245 mm	205 mm	160 mm	K	M
EDL-158	15 / 10 / 5 / 2.5 / 1.25 W	100 V	250 mm	210 mm	85 mm	K	K
EDL-8	10 / 6 / 4 / 2 W	100 V	252 mm	220 mm	80 mm	K	M
EDL-35AB/WS	2 x 6 / 3 / 1.5 W	100 V	245 mm	220 mm	120 mm	M	M
EDL-11 ( TW / SW )	10 / 6 / 4 / 2 W	100 V	269 mm	225 mm	110 mm	M	M
EDL-224AB	2 x 6 / 3 / 1.5 W	100 V	252 mm	230 mm	42 mm	M	M
EDL-38TW	10 / 5 / 2.5 W	100 V	267 mm	230 mm	120 mm	M	M
EDL-10 ( TW )	10 / 6 / 4 / 2 W	100 V	262 mm	235 mm	85 mm	M	M
EDL-28	10 / 5 / 2.5 / 1.25 W	100 V	275 mm	240 mm	75 mm	K	M
EDL-18TW	10 / 5 / 2.5 / 1.25 10 W / 8 ohms	100 V / 8 ohms	285 mm	245 mm	190 mm	K	M
EDL-65TW	30 / 15 / 7.5 W	100 V	280 mm	260 mm	175 mm	K	M
ESP-15/WS	15 / 7.5 / 4 / 2 / 1 W	100 V	220 x 146 mm	190 x 115 mm	70 mm	K	M
ESP-17/WS	15 / 7.5 / 4 / 5 / 1 W	100 V	300 x 214 mm	270 x 185 mm	90 mm	K	M
ESP-22/WS	20 / 15 / 10 / 5 / 2.5 W	100 V	306 x 220 mm	275 x 190 mm	100 mm	K	M
ESP-32/WS	30 / 15 / 7.5 / 4 / 2 W	100 V	358 x 256 mm	330 x 225 mm	100 mm	K	M
SPE-72/WS	20 W ( 40 W max. )	4 ohms	90 mm	73 mm	37 mm	K	K
SPE-82/...	6 W ( 12 W max. )	4 ohms	100 mm	92 mm	57 mm	K	M
SPE-110P/...	10 W ( 30W max. )	4 ohms	132 mm	101 mm	40 mm	K	K
SPE-24	20 W ( 40 W max. )	4 ohms	132 mm	103 mm	60 mm	K	K
CRB-130/WS	20 W ( 40 W max. )	4 ohms	150 mm	110 mm	50 mm	K	K
CRB-230/WS	25 W ( 50 W max. )	4 ohms	150 mm	110 mm	50 mm	K	K
SPE-140/WS	10 W ( 20 W max. )	4 ohms	140 mm	110 mm	30 mm	M	M
SPE-15F/WS	15 W ( 30 W max. )	4 ohms	150 mm	111 mm	25 mm	K	K
SPE-25	20 W ( 40 W max. )	4 ohms	150 mm	113 mm	60 mm	K	K
SPE-150/WS	15 W ( 30 W max. )	4 ohms	153 mm	120 mm	34 mm	M	M
CRB-265/WS	30 W ( 60 W max. )	4 ohms	180 mm	133 mm	60 mm	K	K
SPE-26	20 W ( 40 W max. )	4 ohms	182 mm	134 mm	65 mm	K	K
SPE-16F/WS	15 W ( 30 W max. )	4 ohms	181 mm	134 mm	25 mm	K	K
CRB-165/WS	25 W ( 50 W max. )	4 ohms	180 mm	135 mm	60 mm	K	K
SPE-254/WS	40 W ( 80 W max. )	4 ohms	224 mm	165 mm	68 mm	K	K
SPE-264/WS	45 W ( 90 W max. )	4 ohms	226 mm	190 mm	71 mm	K	K
SPE-284/WS	50 W ( 100 W max. )	4 ohms	250 mm	210 mm	85 mm	K	K
SPE-70/WS	20 W ( 40 W max. )	8 ohms	90 mm	73 mm	37 mm	K	K
SPE-130/WS	20 W ( 40 W max. )	8 ohms	150 mm	110 mm	50 mm	K	K
SPE-230/WS	25 W ( 50 W max. )	8 ohms	150 mm	110 mm	50 mm	K	K
SPE-158/WS	15 W ( 30 W max. )	8 ohms	153 mm	120 mm	34 mm	M	M
SPE-165/WS	25 W ( 50 W max. )	8 ohms	180 mm	133 mm	60 mm	K	K
SPE-265/WS	30 W ( 60 W max. )	8 ohms	180 mm	133 mm	60 mm	K	K

Legend: R = frame F = front grille K = plastic M = metal

**Important Note:** The dimensions may deviate.  
Ceiling cutouts should not be made prior to receiving the speakers.

**EDL-35AB/WS**

Order No. 16.2900

**PA A/B ceiling speaker**

- Flush-mount version for systems with A/B speaker distribution according to EN 60849
- Mounting with metal bracket and subsequent spring suspension of the speaker unit
- 2 separate full range speakers, each with their own transformer
- Robust metal housing and metal grille
- Service-friendly due to spring mechanism
- 3 power taps via ceramic connection terminal with thermal fuse
- Suitable for a ceiling thickness from 10 to 30mm due to adjustable clamping device

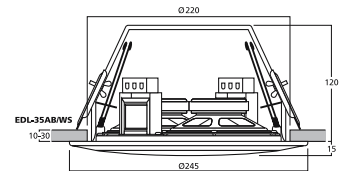
**100V** EN 60849

Model	EDL-35AB/WS
Frequency range	140-20,000Hz
Power capability, 100V	2 x 6/2 x 3/2 x 1.5W <sub>RMS</sub>
SPL (1W/1m)	88dB
Max. rated SPL	95dB
Type of speaker	2 x oval, 60x110mm
Mounting cutout	Ø 220mm
Mounting depth	120mm
Admiss. ambient temp.	0-40 °C
Dimensions	245mm x 125mm
Weight	1.45kg

**ESP-35AB/WS**

Order No. 16.2910

**PA A/B wall and ceiling speaker**

- Surface-mount version for systems with A/B speaker distribution according to EN 60849
- Mounting with metal bracket and subsequent spring suspension of the speaker unit
- Service-friendly due to spring mechanism
- 2 separate full range speakers, each with their own transformer
- Robust metal housing and metal grille
- 3 power taps via ceramic connection terminals with thermal fuse

**100V** EN 60849

Model	ESP-35AB/WS
Frequency range	180-20,000Hz
Power capability, 100V	2 x 6/2 x 3/2 x 1.5W <sub>RMS</sub>
SPL (1W/1m)	88dB
Max. rated SPL	95dB
Type of speaker	2 x oval, 60x110mm
Admiss. ambient temp.	0-40 °C
Dimensions	Ø 280mm x 87mm
Weight	1.55kg

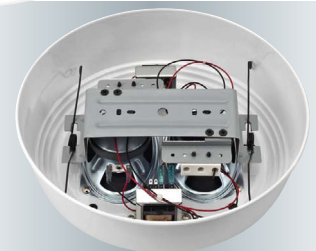

### EDL-224AB

Order No. 16.2520

**PA A/B ceiling speaker**, for systems with A/B speaker distribution according to EN 60849. Ideally suited for smaller PA applications due to the cost-effective reduction of the ceiling cutouts required.

- 2 separate 100mm speakers, each with its own transformer (6W/100V)
- Metal housing
- Quick mounting facility
- 3 power taps via push terminals

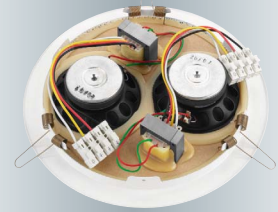
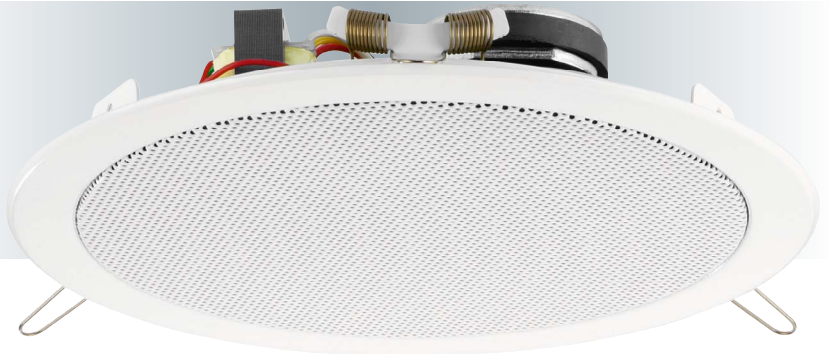
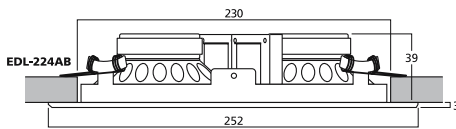

**100V EN 60849**

Model	EDL-224AB
Frequency range	75-20,000Hz
Power capability, 100V	2 x 6/2 x 3/2 x 1.5W <sub>RMS</sub>
Type of speaker	2 x 100
Mounting cutout	ø 230mm
Mounting depth	39mm
Admiss. ambient temp.	-20 to +55°C
Dimensions	ø 252mm x 42mm
Weight	1.5kg

### ESP-78AB/WS

Order No. 16.2760

### ESP-76AB/WS

Order No. 16.2750

**PA A/B wall speakers**, for systems with A/B speaker distribution according to EN 60849.

- 100V line technique
- ESP-78AB/WS: 2 separate oval coaxial speakers (10x15cm), each with its own transformer 20/10/5W
- ESP-76AB/WS: 2 separate oval full range speakers (10x15cm), each with its own transformer 10/6/4W
- Connection via 2 spring-loaded terminals inside the cabinet
- Wooden cabinet with protective metal grille
- Easy wall mounting via supporting plate



**100V EN 60849 Wood**

Model	ESP-78AB/WS	ESP-76AB/WS
Frequency range	120-20,000Hz	120-12,000Hz
Power capability, 100V	2 x 20/10/5W <sub>RMS</sub>	2 x 10/6/4W <sub>RMS</sub>
Type of speaker	100/150	100/150
Admiss. ambient temp.	0-40 °C	0-40 °C
Dimensions	300x200x90mm	300x200x90mm
Weight	3.6kg	2.8kg



**EDL-65TW**

Order No. 16.2220

**Movable PA ceiling speaker**

- 100V line technique
- High power rating with 30W max.
- High-quality 2-way coaxial speaker system with 2-way crossover network
- Dome tweeter
- The complete speaker part can be moved for optimising the stereophonic effect
- Plastic housing of superior design with metal grille
- Plastic material of ABS and self-extinguishing acc. to UL-94V0
- For a ceiling thickness from 9 to 35mm

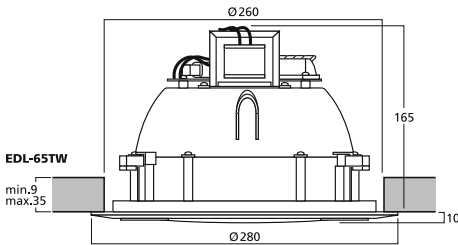

**100V ABS UL-94V0**

Model	EDL-65TW
Frequency range	50-20,000Hz
Power capability, 100V	30/15/7.5W <sub>RMS</sub>
Type of speaker	180
Mounting cutout	ø 260mm x 165mm
Mounting depth	165mm
Admiss. ambient temp.	0-40 °C
Dimensions	ø 280mm x 175mm
Weight	2.4kg

### EDL-38TW

Order No. 16.2080

### EDL-36TW

Order No. 16.2070

**PA ceiling speakers**, for a high safety level in case of a fire.

- 100V line technique
- Additional integrated tweeter
- Fire protection cover
- Metal housing with fitted ceramic terminal
- Thermal fuse 1A/150 °C for disconnecting a faulty speaker in case of a short circuit (fire), so that the function of one speaker line is maintained
- 3-step power selector switch
- Earth connection
- Glass fibre insulated supply line with high-strength cable gland
- Quick-mounting facility
- For a ceiling thickness from 2 to 40mm



**100V Metal Tweeter Fire**

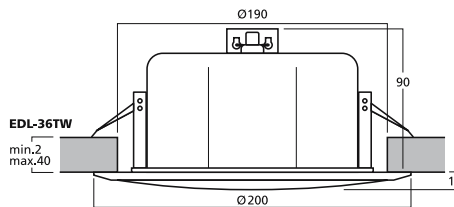
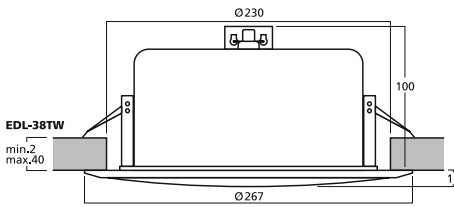

### EDL-35

Order No. 16.2060

### EDL-33

Order No. 16.2050

**PA ceiling speakers**, for a high safety level in case of a fire.

- 100V line technique
- Fire protection cover
- Metal housing with fitted ceramic terminal
- Thermal fuse 1A/150 °C for disconnecting a faulty speaker in case of a short circuit (fire), so that the function of one speaker line is maintained
- 3-step power selector switch
- Earth connection
- Glass fibre insulated supply line with high-strength cable gland
- Quick-mounting facility
- For a ceiling thickness from 2 to 15mm

**100V Metal Fire**

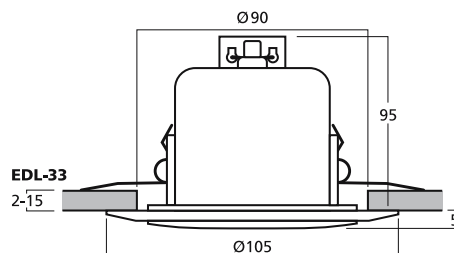
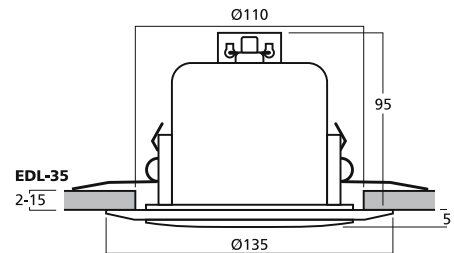

Model	EDL-38TW	EDL-36TW	EDL-35	EDL-33
Frequency range	140-17,000Hz	150-20,000Hz	50-18,000Hz	100-15,000Hz
Power capability, 100V	10/5/2.5W <sub>RMS</sub>	10/5/2.5W <sub>RMS</sub>	6/3/1.5W <sub>RMS</sub>	6/3/1.5W <sub>RMS</sub>
Type of speaker	200	165	100	75
Mounting cutout	ø 230mm x 120mm	ø 190mm x 110mm	ø 110mm x 110mm	ø 90mm x 110mm
Mounting depth	100mm	90mm	95mm	95mm
Admiss. ambient temp.	0-40 °C	0-40 °C	0-40 °C	0-40 °C
Dimensions	ø 267mm x 115mm	ø 200mm x 100mm	ø 135mm x 100mm	ø 105mm x 100mm
Weight	1.8kg	1.5kg	760g	650g

**EDL-18TW**

Order No. 16.1780

**EDL-16TW**

Order No. 16.1770

**PA ceiling speakers**

- 100V line technique or 8Ω operation
- Plastic housing with protective metal grille
- Plastic material of ABS and self-extinguishing acc. to UL-94V0
- Including fire protection cover for a higher safety level
- Additional integrated tweeter
- With 6-step power selector switch for 10/5/2.5/1.25W<sub>RMS</sub>/off or 8Ω operation
- For a ceiling thickness from 8 to 40mm

**100V ABS UL-94V0 Tweeter Fire**

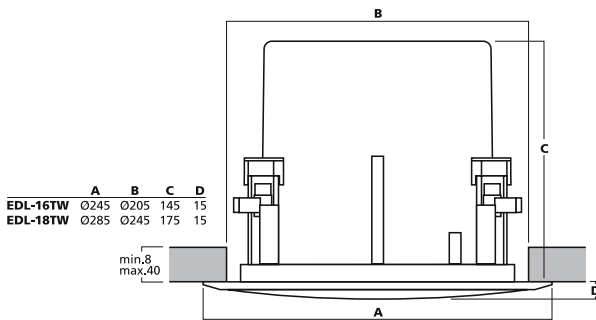

**EDL-206**

Order No. 16.1650

**EDL-205**

Order No. 16.1640

**EDL-204**

Order No. 16.1630



**Weatherproof flush-mount PA speakers**

- 100V line technique
- Full range speaker with dual cone, perfect sound characteristics
- Splashproof due to white one-piece plastic design, high-quality polypropylene cone with rubber surround
- For indoor and outdoor applications
- Supplied with stainless steel mounting screws

**100V ABS Weather**

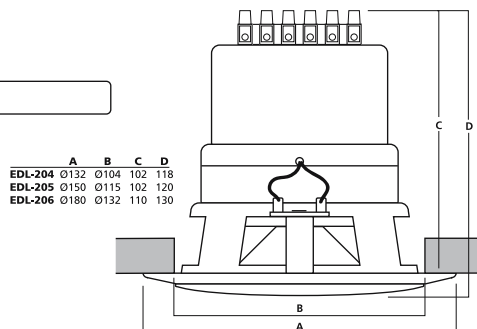

Model	EDL-18TW	EDL-16TW	EDL-206	EDL-205	EDL-204
Frequency range	120-20,000Hz	120-20,000Hz	85-18,000Hz	90-18,000Hz	100-18,000Hz
Power capability, 100V	10/5/2.5/1.25W <sub>RMS</sub>	10/5/2.5/1.25W <sub>RMS</sub>	20/15/10/5/2.5W <sub>RMS</sub>	20/15/10/5/2.5W <sub>RMS</sub>	20/15/10/5/2.5W <sub>RMS</sub>
Power capability, 8Ω	10W/8Ω	10W/8Ω	-	-	-
SPL (1W/1m)	87dB	87dB	-	-	-
Type of speaker	200	165	180	165	100
Mounting cutout	ø 245mm	ø 205mm	ø 132mm	ø 115mm	ø 104mm
Mounting depth	175mm	145mm	110mm	102mm	102mm
Admiss. ambient temp.	0-40 °C	0-40 °C	0-40 °C	0-40 °C	0-40 °C
Dimensions	ø 285mm x 190mm	ø 245mm x 160mm	ø 180mm x 130mm	ø 150mm x 120mm	ø 132mm x 118mm
Weight	3kg	2.3kg	900g	830g	820g

### EDL-11TW

Order No. 16.1210

### EDL-11TW/SI

Order No. 16.2740

### EDL-11TW/SW

Order No. 16.2410

#### PA ceiling speakers

- 100V line technique
- White, silver or black metal housing
- Including fire protection cover for a high safety level
- Additional integrated tweeter
- Quick mounting facility
- For a ceiling thickness from 3 to 20mm

**100V** Metal Tweeter Fire

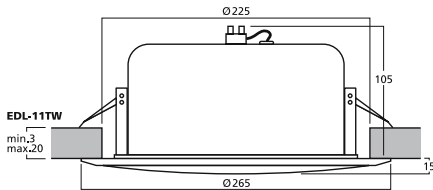

Model	EDL-11TW	EDL-11TW/SI	EDL-11TW/SW
Frequency range	60-20,000Hz	60-20,000Hz	60-20,000Hz
Power capability, 100V	10/5/2.5W <sub>RMS</sub>	10/5/2.5W <sub>RMS</sub>	10/5/2.5W <sub>RMS</sub>
Power capability, 8Ω	-	-	-
Type of speaker	200	200	200
Mounting cutout	ø 225mm x 110mm	ø 225mm x 110mm	ø 225mm x 110mm
Mounting depth	105mm	105mm	105mm
Admiss. ambient temp.	0-40 °C	0-40 °C	0-40 °C
Dimensions	ø 264mm x 120mm	ø 264mm x 120mm	ø 264mm x 120mm
Weight	1.6kg	1.6kg	1.6kg



**EDL-28**

Order No. 16.1460

**EDL-26**

Order No. 16.1450

**EDL-25**

Order No. 16.1440

**EDL-24**

Order No. 16.1430

**PA ceiling speakers**

- 100V line technique via audio transformer with power taps
- Full range speaker with dual cone
- Plastic housing with protective metal grille
- Plastic material of ABS and self-extinguishing acc. to UL-94V0
- For a ceiling thickness from 10 to 40mm

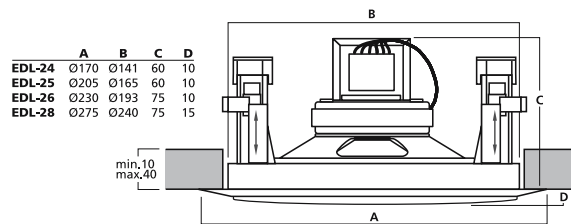
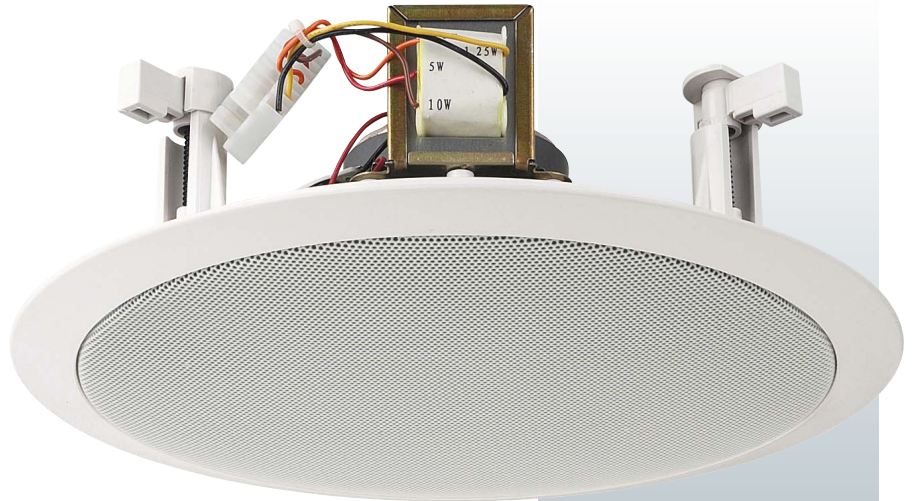

The corresponding radiation angles can be found on the Internet at [www.monacor.com](http://www.monacor.com)

**100V ABS UL-94V0**

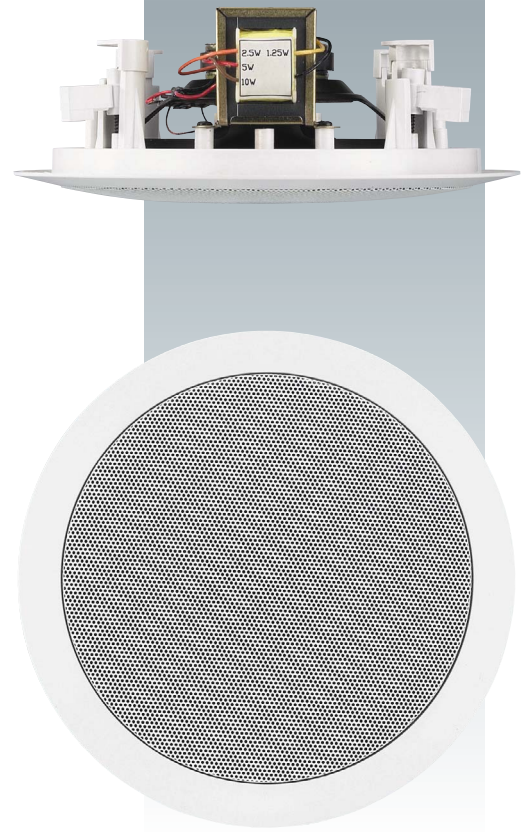

Model	EDL-28	EDL-26	EDL-25	EDL-24
Frequency range	60-14,000Hz	80-14,000Hz	100-14,000Hz	100-14,000Hz
Power capability, 100V	10/5/2.5/1.25W <sub>RMS</sub>	10/5/2.5/1.25W <sub>RMS</sub>	6/3/1.5W <sub>RMS</sub>	6/3/1.5W <sub>RMS</sub>
SPL (1W/1m)	91dB	86dB	87dB	87dB
Max. rated SPL	100dB	95dB	94dB	94dB
Type of speaker	200	165	130	100
Mounting cutout	Ø 240mm	Ø 200mm	Ø 165mm	Ø 142mm
Mounting depth	75mm	75mm	60mm	60mm
Admiss. ambient temp.	0-40 °C	0-40 °C	0-40 °C	0-40 °C
Dimensions	Ø 275mm x 90mm	Ø 230mm x 85mm	Ø 205mm x 70mm	Ø 170mm x 70mm
Weight	1.2kg	910g	830g	750g

### EDL-158

Order No. 16.2930



### EDL-156

Order No. 16.1910



### EDL-155

Order No. 16.2920



**Weatherproof PA ceiling speakers**, heat-resistant up to 100 °C. For applications in saunas and swimming pool areas.

- 100V line technique
- 2-way system with dome tweeter
- Excellent sound
- White plastic housing
- Weatherproof speaker cone
- Tested according to ASTM B117 (400h salt spray test)
- For a ceiling thickness from 2 to 25mm

**100V Plastic Weather Heat**

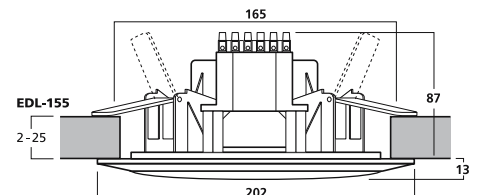
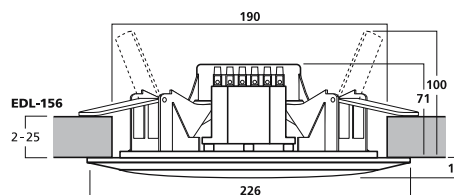
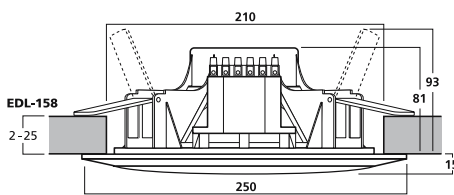

Model	EDL-158	EDL-156	EDL-155
Frequency range	50-16,000Hz	60-20,000Hz	70-18,000Hz
Power capability, 100V	15/10/5/2.5/1.25W <sub>RMS</sub>	15/10/5/2.5/1.25W <sub>RMS</sub>	15/10/5/2.5/1.25W <sub>RMS</sub>
SPL (1W/1m)	89dB	88dB	87dB
Max. rated SPL	101dB	100dB	99dB
Type of speaker	200	180	130
Mounting cutout	ø 210mm	ø 190mm	ø 165mm
Mounting depth	85mm	75mm	95mm
Admiss. ambient temp.	-20 °C to +100 °C	-20 °C to +100 °C	-20 °C to +100 °C
Dimensions	ø 250mm x 96mm	ø 226mm x 100mm	ø 202mm x 100mm
Weight	1.14kg	1.1kg	1.05kg

### EDL-8

Order No. 16.1070

**PA ceiling speaker**

- 100V line technique
- 20cm (8") full range speaker
- Plastic housing with protective metal grille
- For a ceiling thickness from 10 to 43mm

**100V ABS**

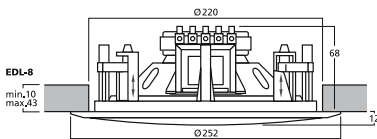

Model	EDL-8
Frequency range	60-14,000Hz
Power capability, 100V	10/6/4/2W <sub>RMS</sub>
Power capability, 8Ω	-
Type of speaker	200
Mounting cutout	ø 220mm
Mounting depth	68mm
Admiss. ambient temp.	0-40 °C
Dimensions	ø 252mm x 80mm
Weight	1kg



**EDL-620**

Order No. 16.2590

**PA ceiling speaker**

- 100V line technique via audio transformer with power taps
- Extra high maximum tapping power
- For a ceiling thickness from 5 to 22mm
- Full range speaker, type 180
- Robust metal version (basket and protective grille)

**100V Metal**

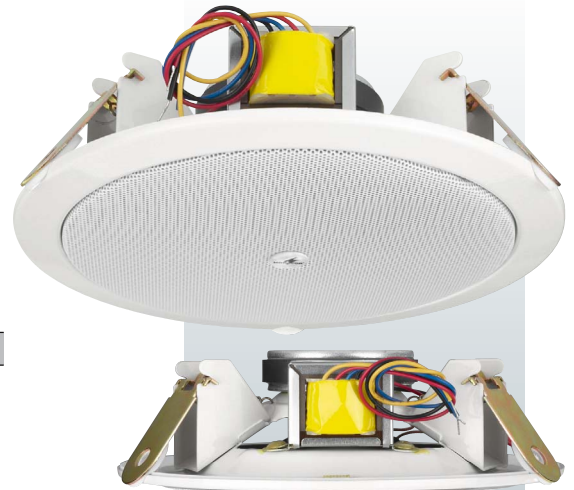
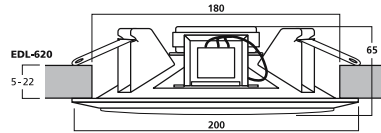

**EDL-612**

Order No. 16.1810

**EDL-606**

Order No. 16.1800

**PA ceiling speakers**

- 100V line technique via audio transformer with power taps
- For a ceiling thickness from 5 to 22mm
- Full range speaker, type 180
- A more powerful reproduction of the range of fundamental notes
- Robust metal version (basket and protective grille)

**100V Metal**

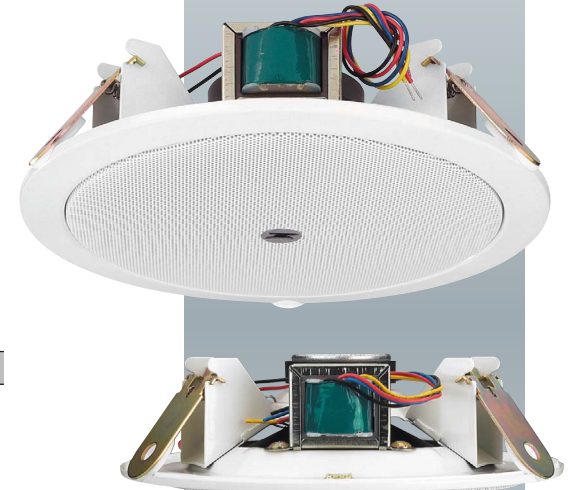
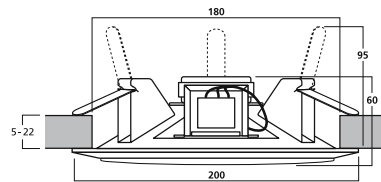

**EDL-605**

Order No. 16.2560

**PA ceiling speaker**

- 100V line technique via audio transformer with power taps
- For a ceiling thickness from 5 to 22mm
- Full range speaker, type 130, in a basket for 180mm cutouts
- Improved omnidirectional radiation of the upper vocal range
- Robust metal version (basket and protective grille)

**100V Metal**

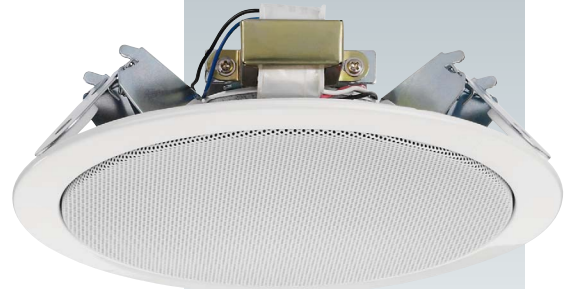
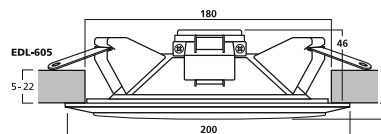

Model	EDL-620	EDL-612	EDL-606	EDL-605
Frequency range	100-20,000Hz	100-20,000Hz	100-20,000Hz	110-15,000Hz
Power capability, 100V	20/10/5W <sub>RMS</sub>	12/6/3W <sub>RMS</sub>	6/3/1.5W <sub>RMS</sub>	6/3W <sub>RMS</sub>
Type of speaker	180	180	180	130
Mounting cutout	ø 180mm	ø 180mm	ø 180mm	ø 180mm
Mounting depth	65mm	95mm	95mm	46mm
Admiss. ambient temp.	0-40 °C	0-40 °C	0-40 °C	0-40 °C
Dimensions	ø 200mm x 65mm	ø 200mm x 95mm	ø 200mm x 95mm	ø 200mm x 54mm
Weight	900g	750g	700g	704g

### EDL-10TW

Order No. 16.1200

### EDL-10

Order No. 16.0030

#### PA ceiling speakers

- 100V line technique
  - Metal housing
  - Quick mounting facility
  - For a ceiling thickness from 10 to 40mm
- EDL-10TW with additional integrated tweeter**

**100V Metal Tweeter**

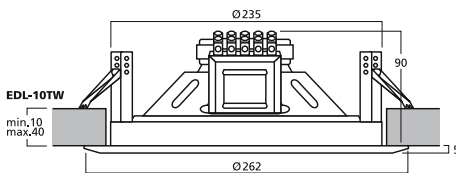

Model	EDL-10TW	EDL-10
Frequency range	50-20,000Hz	50-15,000Hz
Power capability, 100V	10/6/4/2W <sub>RMS</sub>	10/6/4/2W <sub>RMS</sub>
Type of speaker	200	200
Mounting cutout	ø 235mm	ø 235mm
Mounting depth	90mm	90mm
Admiss. ambient temp.	0-40 °C	0-40 °C
Dimensions	ø 262mm x 85mm	ø 262mm x 85mm
Weight	1.5kg	1.4kg

### EDL-68/WS

Order No. 16.2340

#### PA ceiling speaker, with special 2-step mounting.

- 100V line technique
- Snap-in mounting
- For a ceiling thickness from 1 to 30mm
- 2-way coaxial speaker
- Wide frequency range
- Robust metal version (basket and protective grille)
- Speaker additionally secured by a safety rope

**100V Metal**

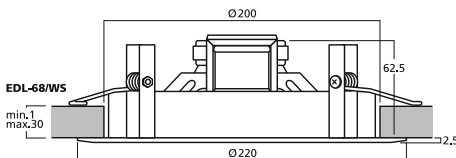

Model	EDL-68/WS
Frequency range	100-19,000Hz
Power capability, 100V	6/3W <sub>RMS</sub>
Type of speaker	165
Mounting cutout	ø 200mm
Mounting depth	65mm
Admiss. ambient temp.	0-40 °C
Dimensions	ø 220mm x 65mm
Weight	1.275kg

For mounting this PA ceiling speaker, the mounting frame is attached to the ceiling cutout at first via the snap-in system. Then, the speaker is inserted into the frame with a bayonet-type locking. A safety rope provides additional safety.

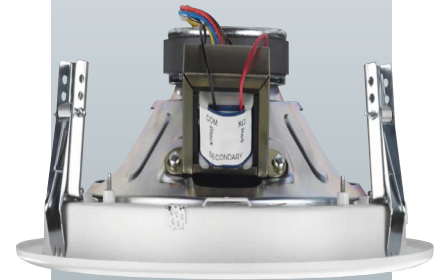

**EDL-150/WS**

Order No. 16.1220

**PA ceiling speaker**

- 100V line technique via audio transformer with 5 power taps
- Full range speaker with dual cone
- Metal housing with white, fixed protective metal grille

100V Metal

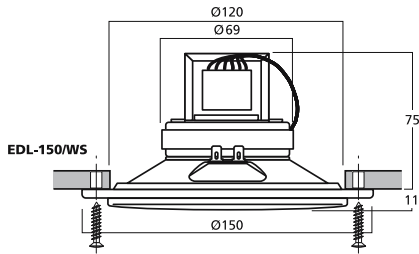

**ESP-32/WS**

Order No. 16.1680

**ESP-22/WS**

Order No. 16.1670

**ESP-17/WS**

Order No. 16.1660

**ESP-15/WS**

Order No. 16.1550

**PA HiFi wall and ceiling speakers**

- 100V line technique, 2-way version with dome tweeter (movable with ESP-22/WS and ESP-32/WS)
- Plastic housing with protective metal grille
- Plastic material of ABS and self-extinguishing acc. to UL-94V0
- Excellent sound characteristics
- For a wall thickness/ceiling thickness from 8 to 35mm



100V ABS UL-94V0 Tweeter

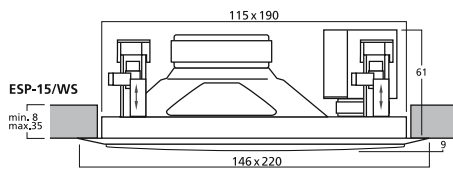
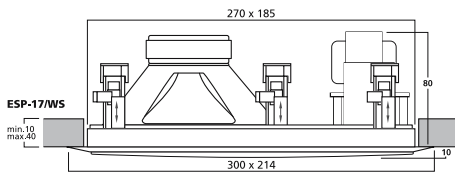
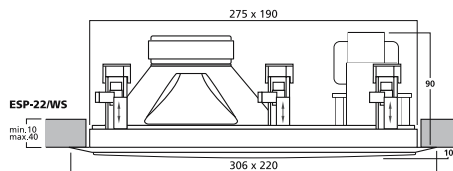
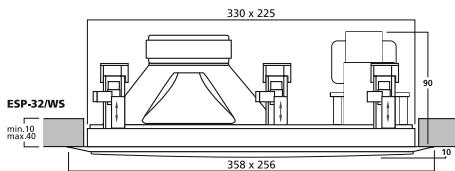

The corresponding radiation angles can be found on the Internet at [www.monacor.com](http://www.monacor.com)

Model	EDL-150/WS	ESP-32/WS	ESP-22/WS	ESP-17/WS	ESP-15/WS
Frequency range	100-12,000Hz	40-20,000Hz	50-20,000Hz	55-20,000Hz	60-20,000Hz
Power capability, 100V	10/5/2.5/1.25/0.625W <sub>RMS</sub>	30/15/7.5/4/2W <sub>RMS</sub>	20/15/10/5/2.5W <sub>RMS</sub>	15/7.5/4/2/1W <sub>RMS</sub>	15/7.5/4/2/1W <sub>RMS</sub>
Type of speaker	130	200	165	130	100
Mounting cutout	ø 120mm	330x225mm	275x190mm	270x185mm	115x190mm
Mounting depth	75mm	90mm	90mm	80mm	61mm
Admiss. ambient temp.	-20 °C to +55 °C	0-40 °C	0-40 °C	0-40 °C	0-40 °C
Dimensions	ø 150mm x 75mm	358x256x100mm	306x220x100mm	300x214x90mm	146x220x70mm
Weight	730g	3.1kg	2.6kg	1.9kg	1.3kg

### EDL-84/WS

Order No. 16.2350

#### PA ceiling speaker

- 100V line technique
- White cover
- Similar design to standard flush-mount halogen lights
- Suitable for speech and background music
- Quick mounting facility
- Plastic housing with protective metal grille
- Plastic material of ABS, not self-extinguishing like EDL-82/WS
- For a ceiling thickness from 2 to 14mm

100V ABS

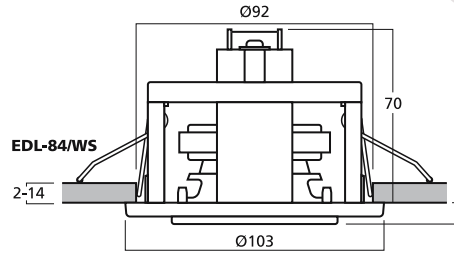

### EDL-82/WS

Order No. 16.1490

#### PA ceiling speaker

- 100V line technique
- White cover
- Similar design to standard flush-mount halogen lights
- Suitable for speech and background music, very consistent frequency response
- Quick mounting facility
- Plastic housing with protective metal grille
- Plastic material of ABS and self-extinguishing acc. to UL-94V0
- For a ceiling thickness from 2 to 14mm

100V ABS UL-94V0

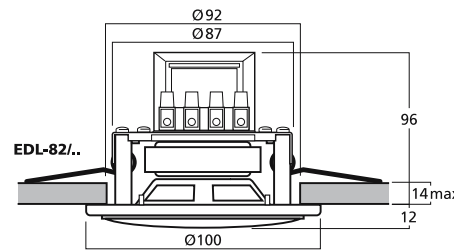

Model	EDL-84/WS	EDL-82/WS
Frequency range	200-19,000Hz	200-20,000Hz
Power capability, 100V	6/3W <sub>RMS</sub>	6/3/1.5W <sub>RMS</sub>
SPL (1W/1m)	86dB	86dB
Max. rated SPL	94dB	94dB
Mounting cutout	ø 92mm	ø 92mm
Mounting depth	80mm	96mm
Admiss. ambient temp.	0-40 °C	0-40 °C
Dimensions	ø 103mm	ø 100mm
Weight	420g	635g

### EDL-22/WS

Order No. 16.2770

PA ceiling speaker, small and compact design, with a very wide bandwidth reproduction.

- 100V line technique
- Quick-mounting facility
- White plastic housing
- For a ceiling thickness from 2 to 10mm

100V ABS

Model	EDL-22/WS
Frequency range	130-20,000Hz
Power capability, 100V	6/3/1.5W <sub>RMS</sub>
Type of speaker	50
Mounting cutout	ø 73mm x 75mm
Mounting depth	67mm
Admiss. ambient temp.	0-40 °C
Dimensions	ø 83mm x 70mm
Weight	320g

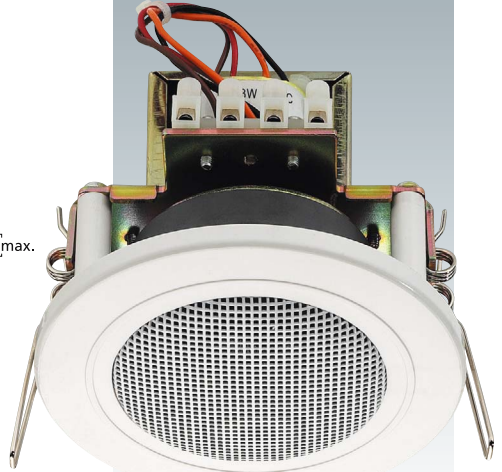
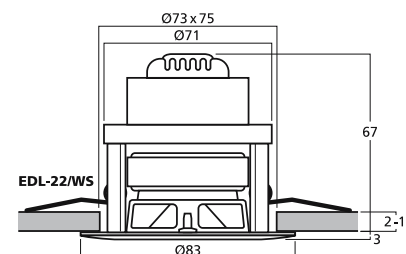

## SPE-284/WS

Order No. 10.5520

## SPE-264/WS

Order No. 10.4900

## SPE-254/WS

Order No. 10.5510

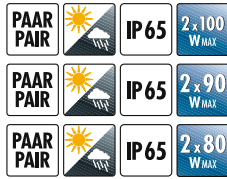

Weatherproof pairs of PA ceiling speakers, heat-resistant up to 100 °C. For applications in saunas and swimming pool areas.

- 2-way system with dome tweeter
- Excellent sound
- White plastic housing
- Weatherproof speaker cone
- Tested according to ASTM B117 (400h salt spray test)
- For a ceiling thickness from 2 to 25mm
- Spring-loaded speaker terminals

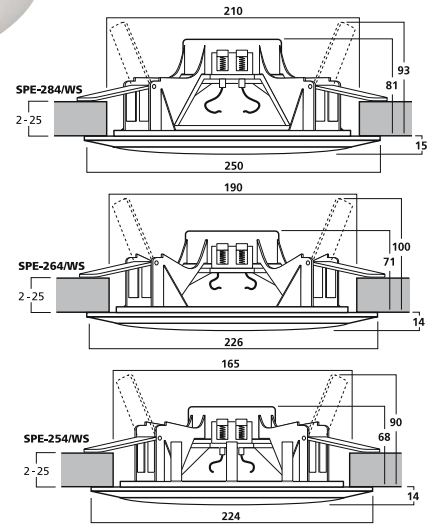
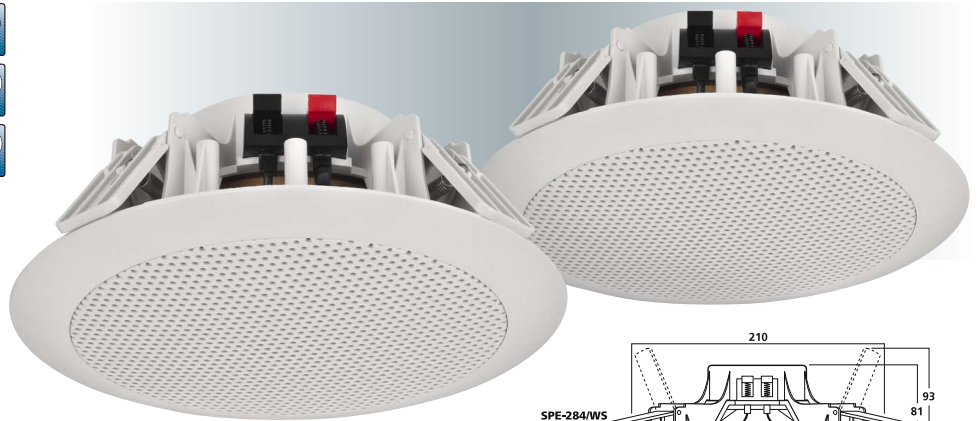

**4Ω** Plastic Weather Tweeter Heat

Model	SPE-284/WS	SPE-264/WS	SPE-254/WS
Frequency range	45-20,000Hz	60-20,000Hz	65-20,000Hz
Power capability, 4Ω	100W <sub>MAX</sub> , 50W <sub>RMS</sub>	90W <sub>MAX</sub> , 45W <sub>RMS</sub>	80W <sub>MAX</sub> , 40W <sub>RMS</sub>
SPL (1W/1m)	89dB	88dB	87dB
Max. rated SPL	104dB	103dB	102dB
Type of speaker	200	165	130
Mounting cutout	ø 210mm	ø 190mm	ø 165mm
Mounting depth	85mm	71mm	68mm
Admiss. ambient temp.	-20 °C to +100 °C	0-40 °C	-20 °C to +100 °C
Dimensions	ø 250mm x 96mm	ø 226mm x 100mm	ø 224mm x 82mm
Weight	0.95kg	0.9kg	0.86kg

## SPE-110P/SW

Order No. 16.2530

## SPE-110P/WS

Order No. 16.2540



Weatherproof flush-mount speakers, 30W<sub>MAX</sub>, 4Ω, heat-resistant up to 120 °C. For saunas and swimming pool areas, as well as other areas where a reliable operation at high temperatures must be ensured.

- Black (SW) or white (WS) plastic housing
- Plastic material of ABS and self-extinguishing acc. to UL-94V0
- Weatherproof speaker cone
- Tested according to ASTM B117 (400h salt spray test)

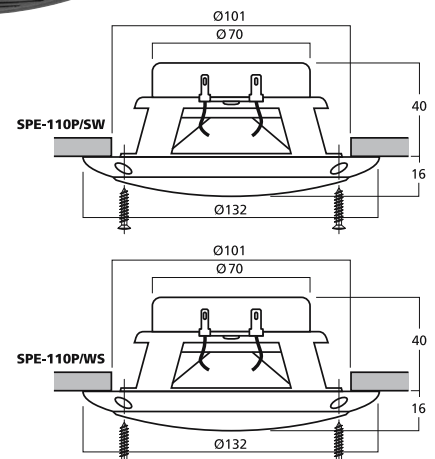

**4 Ω** ABS UL-94V0 Weather Heat

Model	SPE-110P/SW	SPE-110P/WS
Frequency range	180-18,000Hz	180-18,000Hz
Resonant frequency (fs)	250Hz	250Hz
Power capability, 4Ω	30W <sub>MAX</sub> , 15W <sub>RMS</sub>	30W <sub>MAX</sub> , 15W <sub>RMS</sub>
SPL (1W/1m)	86dB	86dB
Type of speaker	130	130
Mounting cutout	ø 101mm	ø 101mm
Mounting depth	40mm	40mm
Admiss. ambient temp.	0-40 °C	0-40 °C
Dimensions	ø 132mm	ø 132mm
Weight	285g	285g

### SPE-26/WS

Order No. 16.2830

### SPE-25/WS

Order No. 16.2820

### SPE-24/WS

Order No. 16.2810



**Weatherproof pairs of flush-mount PA speakers, with UV-stabilised plastic housing.**

For general use in car HiFi or PA applications, on a terrace or a boat, in swimming pool areas.

- 2-way coaxial system
- White plastic housing
- Weatherproof polypropylene speaker cone
- Tested according to ASTM B117 (400h salt spray test)
- Low stray magnetic field
- Supplied with stainless mounting accessories and connection cable

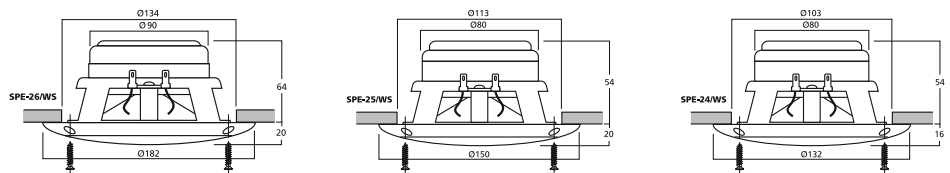

**4Ω Plastic Weather Tweeter**

Model	SPE-26/WS	SPE-25/WS	SPE-24/WS
Frequency range	60-20,000Hz	70-20,000Hz	80-20,000Hz
Power capability, 4Ω	40W <sub>MAX</sub> , 20W <sub>RMS</sub>	40W <sub>MAX</sub> , 20W <sub>RMS</sub>	40W <sub>MAX</sub> , 20W <sub>RMS</sub>
SPL (1W/1m)	89dB	88dB	87dB
Type of speaker	165	130	100
Mounting cutout	ø 134mm	ø 113mm	ø 103mm
Mounting depth	65mm	60mm	60mm
Admiss. ambient temp.	0-40 °C	0-40 °C	0-40 °C
Dimensions	ø 182mm x 84mm	ø 150mm x 75mm	ø 132mm x 70mm
Weight	686g	555g	546g

### SPE-16F/WS

Order No. 16.2850

### SPE-15F/WS

Order No. 16.2840



**Weatherproof pairs of flush-mount PA speakers, with UV-stabilised plastic housing, slimline design.**

For general use in car HiFi or PA applications, on a terrace or a boat, in swimming pool areas.

- White plastic housing for mounting positions of low mounting depth
- Weatherproof polypropylene speaker cone
- Tested according to ASTM B117 (400h salt spray test)
- Low stray magnetic field
- Supplied with stainless mounting accessories and connection cable

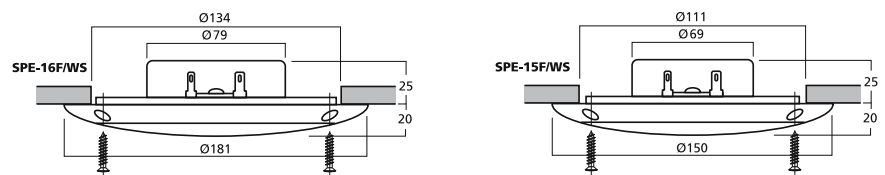

**4Ω Plastic Weather**

Model	SPE-16F/WS	SPE-15F/WS
Frequency range	70-15,000Hz	80-16,000Hz
Power capability, 4Ω	30W <sub>MAX</sub> , 15W <sub>RMS</sub>	30W <sub>MAX</sub> , 15W <sub>RMS</sub>
SPL (1W/1m)	87dB	86dB
Type of speaker	165	130
Mounting cutout	ø 134mm	ø 111mm
Mounting depth	25mm	25mm
Admiss. ambient temp.	0-40 °C	0-40 °C
Dimensions	ø 181mm x 45mm	ø 150mm x 45mm
Weight	315g	270g





CRB-...65/WS  
SPE-...65/WS

CRB-...30/WS  
SPE-...30/WS

**CRB-265/WS**

Order No. 13.0930



**CRB-230/WS**

Order No. 13.0920



Pairs of flush-mount speakers, coaxial system, 4Ω, tweeter with ferrofluid.

Humidity-proof due to white one-piece plastic design and plastic cone, versatile use for car HiFi, PA, terrace, boat.

**CRB-165/WS**

Order No. 13.0910



**CRB-130/WS**

Order No. 13.0900



Pairs of flush-mount speakers, with dual cone, 4Ω.

Humidity-proof due to white one-piece plastic design and plastic cone, versatile use for car HiFi, PA, terrace, boat.

**4Ω Plastic**

**4Ω Plastic**

Model	CRB-265/WS	CRB-230/WS	CRB-165/WS	CRB-130/WS
Impedance	4Ω	4Ω	4Ω	4Ω
Frequency range	80-20,000Hz	100-20,000Hz	80-10,000Hz	80-10,000Hz
Music power	60W	50W	50W	40W
Power rating	30W	25W	25W	20W
Type of speaker	165	130	165	130
Mounting cutout	ø 133mm	ø 110mm	ø 135mm	ø 110mm
Mounting depth	60mm	50mm	60mm	50mm
Magnet	ø 80mm	ø 70mm	ø 80mm	ø 70mm
Magnet weight	230g	150g	230g	150g
Dimensions	ø 180mm	ø 150mm	ø 180mm	ø 150mm
Weight	0.8kg	0.5kg	0.8kg	0.5kg

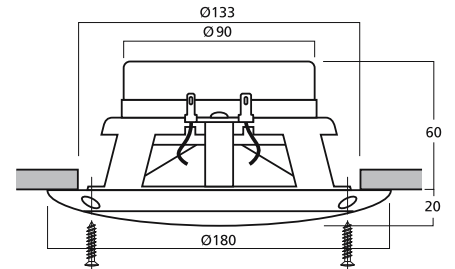

CRB-...65/WS  
SPE-...65/WS

**SPE-265/WS**

Order No. 10.2690



**SPE-230/WS**

Order No. 10.2700



Pairs of flush-mount speakers

- 2-way coaxial system
- Humidity-proof due to one-piece plastic design and plastic cone

**SPE-165/WS**

Order No. 10.2670



**SPE-130/WS**

Order No. 10.2680



Pairs of flush-mount full range speakers

- Dual cone
- Humidity-proof due to one-piece plastic design and plastic cone

**8Ω Plastic**

**8Ω Plastic**

Model	SPE-265/WS	SPE-230/WS	SPE-165/WS	SPE-130/WS
Frequency range	80-20,000Hz	100-20,000Hz	80-10,000Hz	80-10,000Hz
Power capability, 8Ω	60W <sub>MAX</sub> , 30W <sub>RMS</sub>	50W <sub>MAX</sub> , 25W <sub>RMS</sub>	50W <sub>MAX</sub> , 25W <sub>RMS</sub>	40W <sub>MAX</sub> , 20W <sub>RMS</sub>
SPL (1W/1m)	87dB	85dB	87dB	85dB
Type of speaker	165	130	165	130
Mounting cutout	ø 133mm	ø 110mm	ø 133mm	ø 110mm
Mounting depth	60mm	50mm	60mm	50mm
Admiss. ambient temp.	-	0-40 °C	0-40 °C	
Dimensions	ø 180mm	ø 150mm	ø 180mm x 80mm	ø 150mm x 66mm
Weight	0.8kg	0.5kg	800g	500g

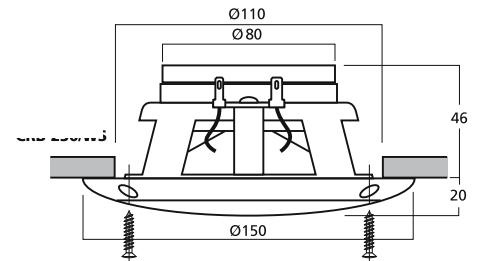

CRB-...30/WS  
SPE-...30/WS

### SPE-150/WS

Order No. 10.1620



### SPE-158/WS

Order No. 10.3150



#### Flush-mount full range speakers

- Dual cone
- Slimline design with fixed metal grille
- Suitable for mounting into ceilings, walls and car doors

4Ω/8Ω Metal

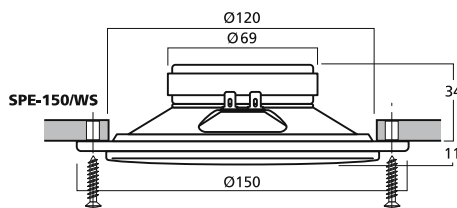
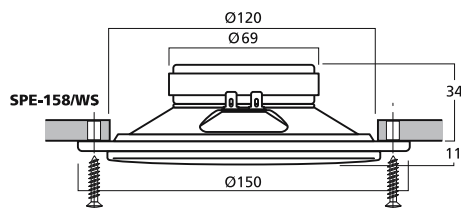

### SPE-140/WS

Order No. 10.4470



#### Flush-mount speaker, 20W<sub>MAX</sub>, 4Ω

- Dual cone for a full range reproduction
- Slimline design
- Fixed metal grille
- Suitable for indoor announcements and background music

4Ω Metal

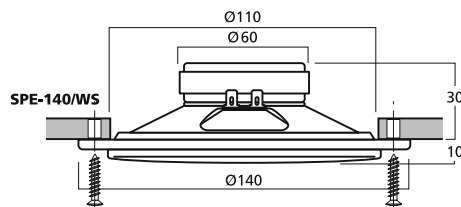

Model	SPE-150/WS	SPE-158/WS	SPE-140/WS
Frequency range	100-12,000Hz	100-12,000Hz	120-12,000Hz
Power capability, 8Ω	-	30W <sub>MAX</sub> , 15W <sub>RMS</sub>	-
Power capability, 4Ω	30W <sub>MAX</sub> , 15W <sub>RMS</sub>	-	20W <sub>MAX</sub> , 10W <sub>RMS</sub>
SPL (1W/1m)	89dB	88dB	87dB
Type of speaker	130	130	130
Mounting cutout	ø 120mm	ø 120mm	ø 110mm
Mounting depth	34mm	34mm	30mm
Admiss. ambient temp.	0-40 °C	0-40 °C	0-40 °C
Dimensions	ø 153mm x 45mm	ø 153mm x 45mm	ø 140mm x 40mm
Weight	500g	500g	300g

**SPE-82/CR**

Order No. 16.1520

**SPE-82/WS**

Order No. 16.1540



**Small flush-mount speakers, 12W<sub>MAX</sub>, 4Ω**

- Chrome (CR) or white (WS) covers
- Similar design to standard flush-mount halogen lights
- Suitable for speech and background music, very consistent frequency response
- Quick mounting facility

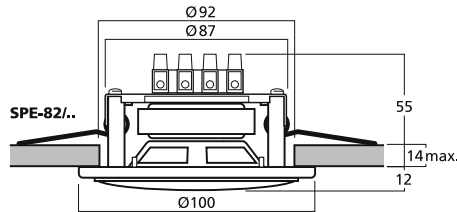

The corresponding radiation angles can be found on the Internet at [www.monacor.com](http://www.monacor.com)

**4Ω ABS**

Model	SPE-82/CR	SPE-82/WS
Frequency range	f3-20,000Hz	f3-20,000Hz
Resonant frequency (fs)	200Hz	200Hz
Power capability, 4Ω	12W <sub>MAX</sub> , 6W <sub>RMS</sub>	12W <sub>MAX</sub> , 6W <sub>RMS</sub>
SPL (1W/1m)	87dB	87dB
Type of speaker	75	75
Mounting cutout	ø 92mm	ø 92mm
Mounting depth	57mm	57mm
Admiss. ambient temp.	0-40 °C	0-40 °C
Dimensions	ø 100mm x 67mm	ø 100mm x 67mm
Weight	340g	340g



**SPE-72/WS**

Order No. 16.2310



**Weatherproof flush-mount full range speaker with dual cone, 40W<sub>MAX</sub>, 4Ω**

Weatherproof speaker of compact size and a high power capability with a wide bandwidth and particularly brilliant reproduction due to a twin cone. High-quality white plastic basket with magnetic sleeve in one piece. Polypropylene cone and mica dual cone. Rubber surround, supplied with matching plastic grille (to be glued in). Suitable for PA applications also in a damp environment and outdoors.

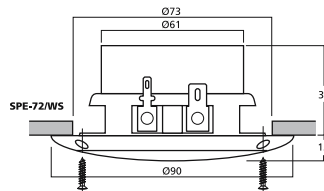

**4Ω Plastic Weather**



**SPE-70/WS**

Order No. 16.2300



**Weatherproof flush-mount full range speaker and bass-midrange speaker, 40W<sub>MAX</sub>, 8Ω**

Weatherproof speaker of compact size and high power capability with a wide bandwidth reproduction. High-quality white plastic basket with magnetic sleeve in one piece. Polypropylene cone, rubber surround, supplied with matching plastic grille (to be glued in). Suitable for PA applications also in a damp environment and outdoors, as a bass-midrange speaker also suitable in small HiFi systems.

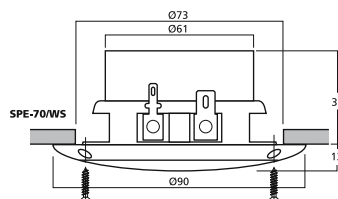

**8Ω Plastic Weather**

Model	SPE-72/WS	SPE-70/WS
Frequency range	100-20,000Hz	100-20,000Hz
Resonant frequency (fs)	100Hz	100Hz
Power capability, 8Ω	-	40W <sub>MAX</sub> , 20W <sub>RMS</sub>
Power capability, 4Ω	40W <sub>MAX</sub> , 20W <sub>RMS</sub>	-
SPL (1W/1m)	86dB	86dB
Type of speaker	75	75
Mounting cutout	ø 73mm	ø 73mm
Mounting depth	37mm	37mm
Admiss. ambient temp.	0-40 °C	0-40 °C
Dimensions	ø 90mm x 50mm	ø 90mm x 50mm
Weight	230g	230g



UWS speakers from MONACOR: the perfect technology to transmit music where normally hardly anything can be heard - underwater! A sophisticated sound-generating technology which is perfectly matched to underwater requirements, provides both an amazingly good sound quality and speech intelligibility as well as a high level stability.

### UWS-130

Order No. 16.2670



**Underwater speaker, 20W<sub>MAX</sub>, 15W<sub>RMS</sub>, 8Ω**

Underwater speaker of modern design with a pool blue plastic housing and 3-point surface mounting. 3 covered screw connections for wall mounting (ideally in a water depth of 1-1.2 metres). At a water depth of under 1.2 metres, a setup on the floor is also possible. Provides a good sound and a high level stability. To be connected to any kind of standard audio amplifier (capable of 2-8Ω). Cannot be used for 100V or 70V transmissions! **An operation with a speaker protection module DSP-1 which is adjusted accordingly is recommended. It will protect the UWS-130 against overload, because the volume level of the underwater speaker cannot be heard outside the water and above the water surface area.**

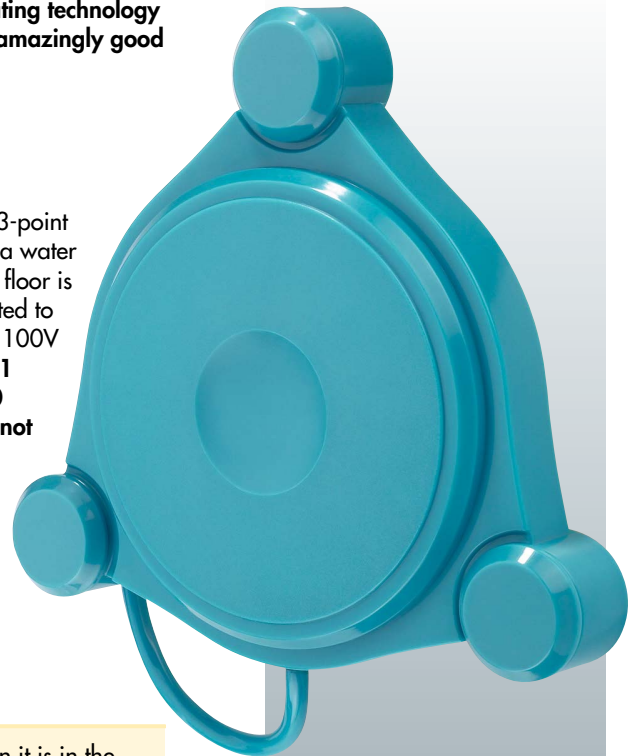
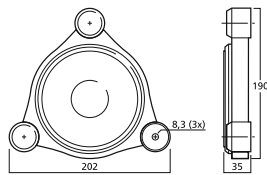

The radiation of both the sound and the volume is different underwater than it is in the air. Thus, it is recommended to try out for the ideal position of the underwater speakers in order to obtain perfect results. Basically, the sound of the systems is always to be evaluated underwater. There is practically no sound to be heard above the water surface area. For greater capacities or for achieving higher volume levels, the application of several underwater speakers is recommended which should generally be distributed evenly. One single underwater speaker is able to sufficiently radiate the sound in about 25m<sup>3</sup> of water.

### UWS-100

Order No. 16.2700



**Underwater speaker, 35W<sub>MAX</sub>, 20W<sub>RMS</sub>, 8Ω**

Practical underwater speaker with a white plastic housing. Due to suction cups, suitable for temporary and mobile applications (integrated carrying handle), but also for installation purposes. Ideal mounting in a water depth of 0.3-0.8 metres. At a water depth of under 1.5 metres, a setup on the floor is also possible. Provides a good sound and a high level stability. To be connected to any kind of standard audio amplifier (capable of 2-8Ω). Cannot be used for 100V or 70V transmissions! **An operation with a speaker protection module DSP-1 which is adjusted accordingly is recommended. It will protect the UWS-100 against overload, because the volume level of the underwater speaker cannot be heard outside the water and above the water surface area.**

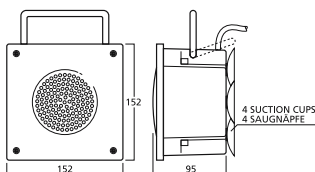

Model	UWS-130	UWS-100
Power rating	20W <sub>MAX</sub> , 15W <sub>RMS</sub>	35W <sub>MAX</sub> , 20W <sub>RMS</sub>
Impedance	8Ω	8Ω
Frequency range	80-20,000	100-20,000
Efficiency (SPL/1m)	> 100dB	> 91dB
Recommended mounting depth	1-1.2m	0.3-0.8m
Max. mounting depth	5m	5m
Admiss. ambient temp.	1-40 °C	1-40 °C
Dimensions	ø 230mm x 35mm	140x140x85mm
Weight	1.9kg	1.6kg
Connections	cable length: 5m with bare cable ends	cable length: 5m with bare cable ends

Special speakers which show completely new ways of invisible PA applications: the super dispersion ceiling speakers effectively utilise an open baffle technology for PA ceiling applications.

**EDL-310L**

Order No. 16.2490

**Super dispersion PA ceiling speaker**

- 100V line technique with 3 power taps up to 10W<sub>RMS</sub>
- High-quality full range speaker (20cm) with an exceptionally good linearity, extensive bass reproduction and high efficiency
- For all suspended ceilings and for free suspension
- Easiest installation by simply resting the speaker on the ceiling grid or suspending it above the ceiling (to prevent rattling noise with lightweight ceilings)
- A very good sound with excellent stereophony with all suspended ceiling grids
- With most of the more soundproof ceilings, typical treble dampening can be compensated to a large extent by simply readjusting the treble control at the amplifier and background PA applications can be realised without any cutouts or visible speakers
- Dimensions: 300mm x 300mm, required clearance above the ceiling when resting the speaker directly on the grid: > 10cm, when suspending it above the ceiling: > 25cm
- The sound absorption plate is fitted with 3 foam rubber pads for resting the speaker on the grid and 3 predrilled holes for suspending it

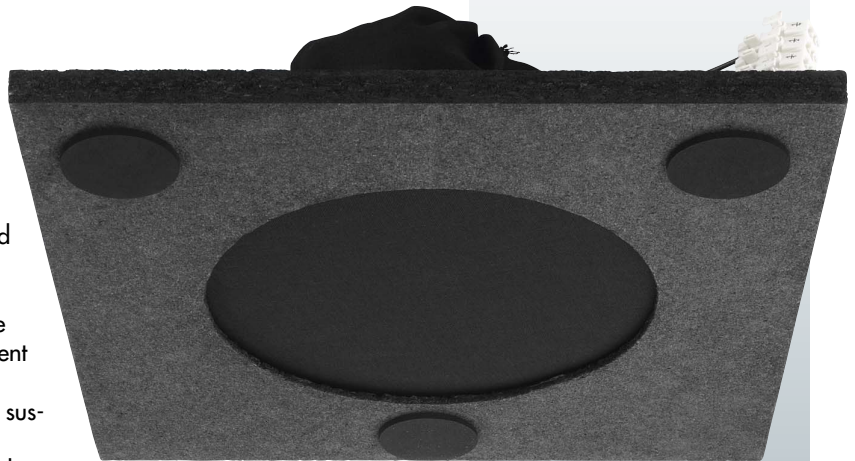

100 V

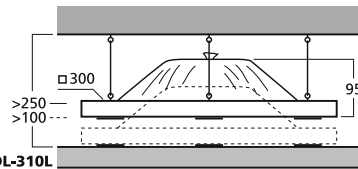

EDL-310L



**EDL-300L**

Order No. 16.2180

**Super dispersion PA ceiling speaker**

- 100V line technique with 3 power taps
- For all suspended ceilings and for free suspension
- Easiest installation by simply resting the speaker on the ceiling grid or suspending it above the ceiling (to prevent rattling noise with lightweight ceilings)
- High-quality full range speaker (13cm) with an exceptionally good linearity
- A very good sound with excellent stereophony with all suspended ceiling grids
- With most of the more soundproof ceilings, typical treble dampening can be compensated to a large extent by simply readjusting the treble control at the amplifier and background PA applications can be realised without any cutouts or visible speakers
- Dimensions: 300mm x 300mm, required clearance above the ceiling when resting the speaker directly on the grid: > 10cm, when suspending it above the ceiling: > 25cm
- The sound absorption plate is fitted with 3 foam rubber pads for resting the speaker on the grid and 3 predrilled holes for suspending it

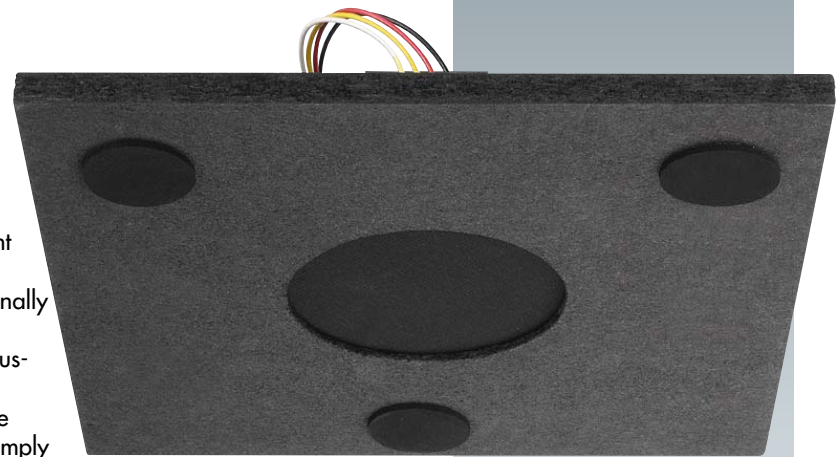

100 V

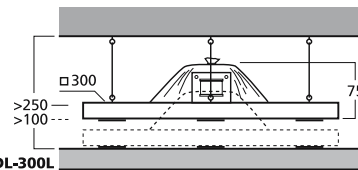

EDL-300L



Model	EDL-310L	EDL-300L
Frequency range	50-18,000Hz	90-20,000Hz
Power capability, 100V	10/5/2.5W <sub>RMS</sub>	6/3/1.5W <sub>RMS</sub>
Type of speaker	200	130
Admiss. ambient temp.	0-40 °C	0-40 °C
Dimensions	300x300x95mm	300x300x75mm
Weight	1.9kg	1.4kg

### ESP-8U

Order No. 16.2170

#### PA wall and ceiling speaker for flush mounting

- 100V line technique via audio transformer with 3 power taps
- Perfect sound presence for a powerful voice reproduction with a very high audibility
- 20cm speaker of very high efficiency (99dB/1W/1m)
- Plastic tray for flush mounting in walls or solid ceilings
- Required hole in wall: approx. 242x242x100mm
- Metal front grille with plastic frame

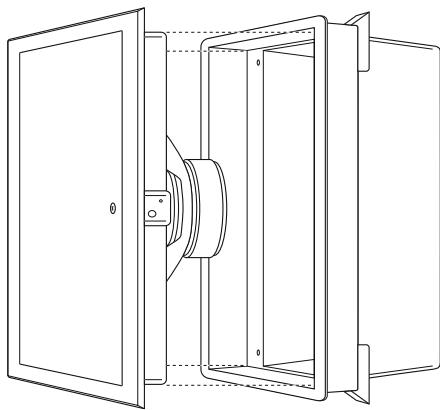

100 V



### ESP-5U

Order No. 16.2160

#### PA wall and ceiling speaker for flush mounting

- 100V line technique via audio transformer with 3 power taps
- Wide bandwidth radiation for a pleasant music reproduction
- 13cm speaker of high efficiency (94dB/1W/1m)
- Plastic tray for flush mounting in walls or solid ceilings
- Required hole in wall: approx. 242x242x100mm
- Metal front grille with plastic frame

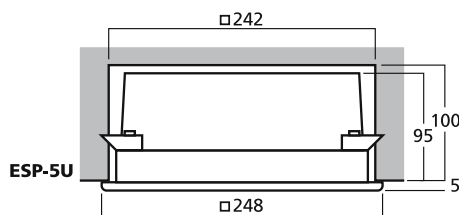
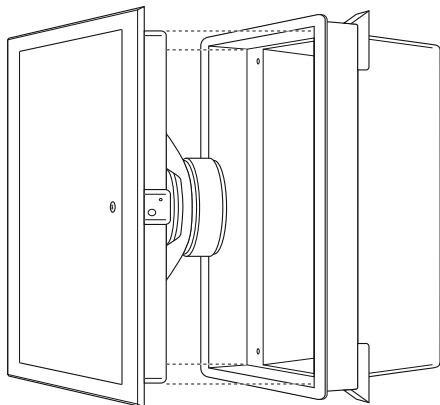

100 V



Model	ESP-8U	ESP-5U
Frequency range	200-17,000Hz	100-19,000Hz
Power capability, 100V	6/3/1.5W <sub>RMS</sub>	6/3/1.5W <sub>RMS</sub>
Type of speaker	200	130
Admiss. ambient temp.	0-40 °C	0-40 °C
Dimensions	248x248x100mm	248x248x100mm
Weight	1.7kg	1.4kg

**ESP-72/WS**

Order No. 16.2130

**PA wall speaker, white**

- 100V line technique
- 2-way coaxial speaker, providing a high-quality sound
- 5-step rotary switch for 20/10/5/2.5W<sub>RMS</sub>/off
- Rotary switch can be replaced with a cover plate to avoid accidental changing of the power selection
- Emergency priority relay
- Wooden cabinet with protective metal grille
- Easy wall mounting via supporting plate

**100V** Wood Tweeter

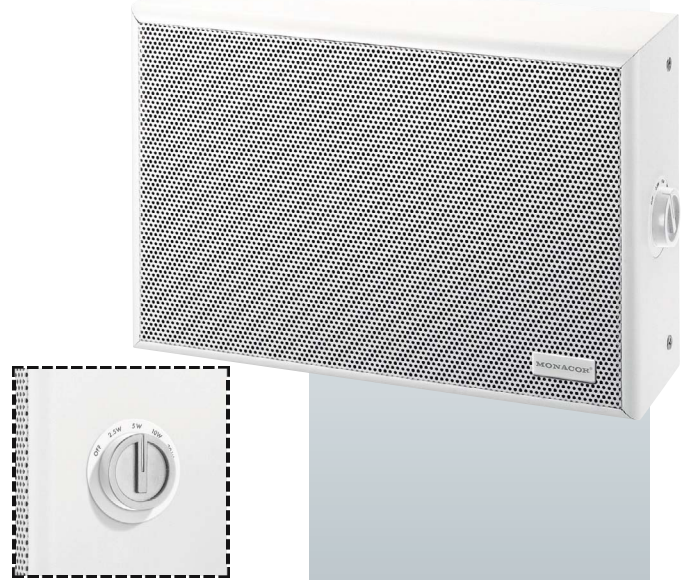

**ESP-70/WS**

Order No. 16.2120

**PA wall speaker, white**

- 100V line technique
- 5-step rotary switch for 10/6/4/2W<sub>RMS</sub>/off
- Rotary switch can be replaced with a cover plate to avoid accidental changing of the power selection
- Emergency priority relay
- Wooden cabinet with protective metal grille
- Easy wall mounting via supporting plate

**100V** Wood



**ESP-40/WS**

Order No. 16.1090

**ESP-60/WS**

Order No. 16.1110

**PA wall speakers**

- 100V line technique via audio transformer with 4 power taps
- White wooden cabinet, without rear panel, foam front cover
- Supplied with mounting screws

**100V** Wood



Model	ESP-72/WS	ESP-70/WS	ESP-40/WS	ESP-60/WS
Frequency range	85-20,000Hz	95-19,000Hz	60-8,000Hz	60-8,000Hz
Power capability, 100V	20/10/5/2.5W <sub>RMS</sub>	10/6/4/2W <sub>RMS</sub>	6/4/2/1W <sub>RMS</sub>	6/4/2/1W <sub>RMS</sub>
Admiss. ambient temp.	0-40 °C	0-40 °C	0-40 °C	0-40 °C
Dimensions	300x200x90mm	300x200x90mm	230x170x80mm	300x200x90mm
Weight	2.8kg	2.3kg	1.3kg	1.6kg

### WL-6T6/WS

Order No. 16.1790

#### PA wall speaker

- 100V line technique via audio transformer with 3 power taps
- Full range speaker with dual cone
- Plastic cabinet with protective metal grille
- Supplied with mounting screws

100V ABS

### ESP-152/WS

Order No. 16.2150

#### PA wall speaker

- 100V line technique via audio transformer with 3 power taps
- High-quality sound, capable of high volumes due to 2-way coaxial system
- Plastic cabinet of a special design (open rear panel) with protective metal grille
- Protected against ball rebound
- Supplied with mounting screws and cover plates for the screws

100V Plastic Protected against ball rebound

### ESP-360/WS

Order No. 16.1900

#### PA wall speaker, white

- 100V line technique via audio transformer with 2 power taps
- Full range speaker with dual cone
- Plastic cabinet
- Curved cabinet for a perfect radiation angle

100V Plastic

Model	WL-6T6/WS	ESP-152/WS	ESP-360/WS
Frequency range	100-20,000Hz	100-20,000Hz	130-15,000Hz
Power capability, 100V	6/3/1.5W <sub>RMS</sub>	15/7.5/3.75W <sub>RMS</sub>	6/3W <sub>RMS</sub>
Dimensions	210x312x85mm	240x330x85mm	185x255x123mm
Weight	1.4kg	2kg	1.1kg





**ESP-130/WS**

Order No. 16.1600

**ESP-130/SI**

Order No. 16.1840

**PA wall speakers**

- 100V line technique via audio transformer with 2.5W and 5W power taps
- 2-way system with neodymium bass-midrange speaker and dome tweeter
- Plastic cabinet with protective metal grille
- Slimline design for unobtrusive wall mounting

ESP-130/WS = white plastic cabinet

ESP-130/SI = silver lacquered plastic cabinet

**100V** ABS

Model	ESP-130/WS	ESP-130/SI
Frequency range	80-18,000Hz	80-18,000Hz
Power capability, 100V	5/2.5W <sub>RMS</sub>	5/2.5W <sub>RMS</sub>
Admiss. ambient temp.	0-40°C	0-40 °C
Dimensions	185x275x38mm	185x275x38mm
Weight	1.2kg	1.2kg

**SMB-130/WS**

Order No. 09.0490

**SMB-130/SI**

Order No. 09.0540



**Pairs of slimline speaker systems, 40W<sub>MAX</sub>, 4Ω**

2-way system with neodymium bass-midrange speaker and dome tweeter. With integrated wall holder. Unobtrusive design with a very pleasant radiation and good level stability. Perfectly suitable for any background PA application, also excellent as rear speakers in surround systems.

SMB-130/WS = white plastic cabinet

SMB-130/SI = silver lacquered plastic cabinet

**4Ω** ABS

Model	SMB-130/WS	SMB-130/SI
Impedance	4Ω	4Ω
Frequency range	80-18,000Hz	80-18,000Hz
Crossover frequency	5,000Hz	5,000Hz
Power rating	40W <sub>MAX</sub> , 20W <sub>RMS</sub>	40W <sub>MAX</sub> , 20W <sub>RMS</sub>
SPL (1W/1m)	88dB	88dB
Dimensions	185x275x38mm	185x275x38mm
Weight	1kg	1kg

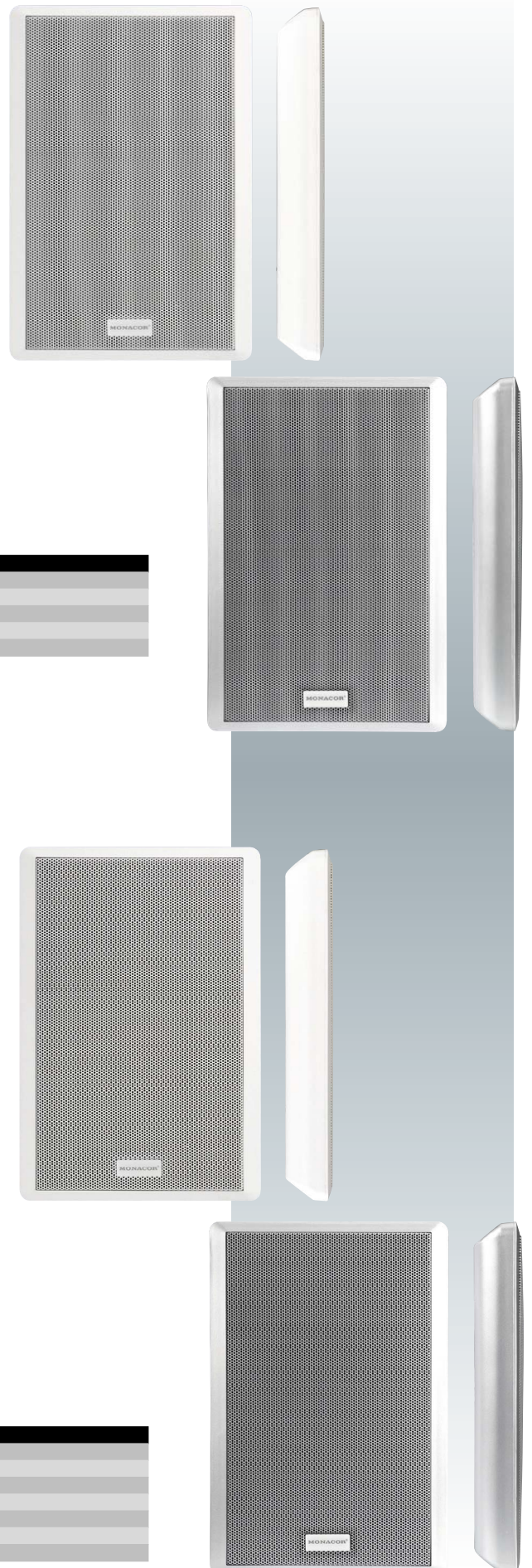

## ESP-80/WS

Order No. 16.2380

**PA wall speaker**, vandal-resistant.

- 100V line technique via audio transformer with 4 power taps
- Full range speaker with a good voice reproduction, suitable for background music
- Very robust 2-piece metal cabinet

**100V** Metal Protected against ball rebound

Model	ESP-80/WS
Frequency range	250-10,000Hz
Power capability, 100V	6/3/1.5/0.75W <sub>RMS</sub>
Power capability, 8Ω	-
Admiss. ambient temp.	0-40 °C
Dimensions	170x170x63mm
Weight	1.3kg

## ESP-90/WS

Order No. 16.2680

**PA wall speaker**

- 100V line technique via audio transformer with 3 power taps
- White plastic cabinet (surface-mount version with open rear panel) with protective metal grille
- Supplied with mounting accessories

**100V** Plastic

Model	ESP-90/WS
Frequency range	80-19,000Hz
Power capability, 100V	6/3/1.5W <sub>RMS</sub>
Power capability, 8Ω	-
Type of speaker	130
Admiss. ambient temp.	0-40 °C
Dimensions	∅ 168mm x 72mm
Weight	600g

## SPE-85/WS

Order No. 16.1030



**Surface-mount speaker**

- Humidity-proof due to water-repellent segments and speaker with plastic cone
- Especially suitable for the reproduction of alarm signals

**8Ω** Plastic

Model	SPE-85/WS
Frequency range	350-8,000Hz
Power capability, 8Ω	10W <sub>MAX</sub> , 5W <sub>RMS</sub>
SPL (1W/1m)	95dB
Admiss. ambient temp.	0-40 °C
Dimensions	110x110x57mm
Weight	400g



**EDL-420/WS**

Order No. 16.1880



IP44

**EDL-412/WS**

Order No. 16.1860



IP44

**Weatherproof PA ball speakers**

- 100V line technique or 8Ω operation
- White ABS cabinet (self-extinguishing, acc. to standard UL-94V0)
- Supplied with 480cm connection cable and canopy

100V	8Ω	ABS	UL-94V0	Weather
------	----	-----	---------	---------

**EDL-430/WS**

Order No. 16.2370

360°

**Top-quality PA ball speaker, with a perfect omnidirectional sound radiation.**

- 100V line technique
- Speaker configuration of particularly high-quality
- Extensive reflector design
- High-quality sound, also suitable for radiating music
- White ABS cabinet
- 150cm connection cable with canopy

100V	ABS
------	-----



Model	EDL-420/WS	EDL-412/WS	EDL-430/WS
Frequency range	120-20,000Hz	160-20,000Hz	80-15,000Hz
Power capability, 100V	20/10/5W <sub>RMS</sub>	10/5/2.5W <sub>RMS</sub>	20/10/5W <sub>RMS</sub>
Power capability, 8Ω	20W/8Ω	10W/8Ω	-
SPL (1W/1m)	94dB	92dB	92dB
Admiss. ambient temp.	0-40 °C	-	0-40 °C
Dimensions	ø 265mm	ø 184mm	ø 250mm
Weight	2.2kg	1.7kg	2.2kg

### EDL-420B/WS

Order No. 16.1890



### EDL-412B/WS

Order No. 16.1870



#### Weatherproof PA ball speakers

- 100V line technique or 8Ω operation
- White ABS cabinet (self-extinguishing, acc. to standard UL-94V0)
- Metal bracket for wall mounting and ceiling suspension, movable, with tooth locking mechanism
- 75cm connection cable



**100V** 8Ω ABS UL-94V0 Weather

### EDL-222/WS

Order No. 16.2690



#### PA wall and ceiling speaker

- 100V line technique
- 2 speakers for bilateral radiation
- High-quality sound with an excellent linearity and a reproduction of a wide brilliance frequency range
- Appealing ABS housing with coated steel protective grille
- Connection cable with 4 power taps
- Ceramic terminal block with fuse

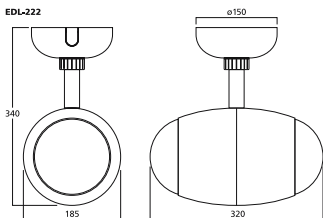

**100V** 2 x speaker ABS UL-94V0

Model	EDL-420B/WS	EDL-412B/WS	EDL-222/WS
Frequency range	120-20,000Hz	160-20,000Hz	70-20,000Hz
Power capability, 100V	20/10/5W <sub>RMS</sub>	10/5/2.5W <sub>RMS</sub>	20/10/5/2.5W <sub>RMS</sub>
Power capability, 8Ω	20W/8Ω	10W/8Ω	-
SPL (1W/1m)	94dB	92dB	86dB
Type of speaker	-	-	2 x 130
Admiss. ambient temp.	0-40 °C	0-40 °C	0-40 °C
Dimensions	ø 265mm	ø 184mm	185x340x320mm
Weight	2.5kg	1.9kg	3.9kg

**EDL-213**

Order No. 16.2890

**Weatherproof PA wall and ceiling projector speaker**

- 100V line technique
- 2 x 13cm full range speaker with impregnated cone for bidirectional radiation
- Hose-proof due to ABS plastic cabinet with rubber seals and high-strength cable gland
- Robust mounting arm with joint for panning and tilting allows mounting in most varying angles
- 3 power taps

100V	ABS	Weather	2 x speaker
------	-----	---------	-------------

**EDL-113**

Order No. 16.2880

**Weatherproof PA wall and ceiling projector speaker**

- 100V line technique
- 13cm full range speaker with impregnated cone
- Directional radiation
- Hose-proof due to ABS plastic cabinet with rubber seals and high-strength cable gland
- Robust mounting arm with joint for panning and tilting allows mounting in most varying angles
- 3 power taps

100V	ABS	Weather
------	-----	---------



Model	EDL-213	EDL-113
Frequency range	80-20,000Hz	80-20,000Hz
Power capability, 100V	20/15/10W <sub>RMS</sub>	15/10/5W <sub>RMS</sub>
SPL (1W/1m)	90dB	90dB
Max. rated SPL	102dB	100dB
Type of speaker	2 x 130	130
Admiss. ambient temp.	0-40 °C	0-40 °C
Dimensions	457x200x174mm	315x200x174mm
Weight	3.4kg	2.5kg

## EDL-255/WS

Order No. 16.0860

### PA wall and ceiling speaker

- 100V line technique or 8Ω operation
- 6-step power selector switch for 15/8/4/2W<sub>RMS</sub>/off or 8Ω operation
- White plastic cabinet with movable mounting bracket

100V 8Ω ABS

The corresponding radiation angles can be found on the Internet at [www.monacor.com](http://www.monacor.com)



## EDL-250/WS

Order No. 16.2290



## EDL-245/WS

Order No. 16.1750



### Weatherproof PA wall and ceiling speakers

- 100V line technique
- Protected against powerful water jets
- Weatherproof plastic cabinet
- Connection cable with 3 power taps
- Movable mounting bracket

100V ABS Weather



## EDL-110/WS

Order No. 16.1930



### Weatherproof PA wall and ceiling speaker

- 100V line technique
- 1 speaker with polypropylene cone
- Splashproof due to plastic cabinet with rubber seals and high-strength cable gland
- Connection cable with 3 power taps
- Movable mounting bracket and screws made of stainless steel

100V Weather



Model	EDL-255/WS	EDL-250/WS	EDL-245/WS	EDL-110/WS
Frequency range	100-15,000Hz	125-15,000Hz	150-15,000Hz	120-20,000Hz
Power capability, 100V	15/8/4/2W <sub>RMS</sub>	30/15/7.5W <sub>RMS</sub>	6/3/1.5W <sub>RMS</sub>	10/5/2.5W <sub>RMS</sub>
Power capability, 8Ω	15W/8Ω	-	-	-
SPL (1W/1m)	92dB	101dB	98dB	94dB
Admiss. ambient temp.	0-40 °C	0-40 °C	0-40 °C	-20 °C to +55 °C
Dimensions	ø 180mm x 280mm	ø 180mm x 200mm	ø 180mm x 200mm	ø 180mm x 270mm
Weight	3kg	2.1kg	1.8kg	2kg

**EDL-220/WS**

Order No. 16.1950



**Weatherproof PA wall and ceiling speaker**

- 100V line technique
- 2 speakers with polypropylene cone for bilateral radiation
- Splashproof due to plastic cabinet with rubber seals and high-strength cable gland
- Connection cable with 3 power taps
- Movable mounting bracket and screws made of stainless steel

**100V Weather 2 x speaker**

**EDL-112/WS**

Order No. 16.1720



**Weatherproof professional PA wall and ceiling speaker**

- 100V line technique
- With 2 built-in speakers and bilateral radiation
- Protected against powerful water jets
- Weatherproof aluminium cabinet
- Connection cable with 3 power taps
- Movable mounting bracket and screws made of stainless steel

**100V Aluminium Weather 2 x speak.**

The corresponding radiation angles can be found on the Internet at [www.monacor.com](http://www.monacor.com)

**EDL-115/WS**

Order No. 16.1730



**Weatherproof PA wall and ceiling speaker**

- 100V line technique
- Protected against powerful water jets
- Weatherproof aluminium cabinet
- Connection cable with 3 power taps
- Movable mounting bracket and screws made of stainless steel

**100V Aluminium Weather**



Model	EDL-220/WS	EDL-112/WS	EDL-115/WS
Frequency range	120-20,000Hz	140-20,000Hz	130-20,000Hz
Power capability, 100V	20/10/5W <sub>RMS</sub>	12/6/3W <sub>RMS</sub>	15/7.5/3.75W <sub>RMS</sub>
SPL (1W/1m)	94dB	88dB	90dB
Admiss. ambient temp.	0-40 °C	-20 °C to +55 °C	-20 °C to +55 °C
Dimensions	ø 180mm x 251mm	150x150x205mm	150x150x175mm
Weight	2.75kg	3.1kg	2.4kg

Real landmarks in the 100V speaker technology concerning sound and appearance. These ESP speaker systems from MONACOR are not only available in an appealing design, the applied technology belongs to the top range of available speaker technology and makes these speaker systems real highlights both in the PA technology and in home audio applications (8Ω operation!).

### ESP-6HQ

Order No. 16.1990



Pair of high-performance 100V speakers, each speaker system up to 35W<sub>RMS</sub> in 100V operation or up to 180W<sub>MAX</sub>/100W<sub>RMS</sub> in 8Ω operation

2-way speaker systems in an oval-shaped ABS cabinet (bass-reflex) of a special design, 16cm bass speaker (carbon fibre cone as well as a voice coil wound on the inside and outside) and a 30mm special dome tweeter (with waveguide), with an extra dynamic and realistic sound for any kind of music and voice transmission with a very high level stability. A perfectly powerful and deep bass reproduction. The ESP-6HQ is the perfect solution for PA applications in function rooms or conference rooms and for presentations. Home HiFi, home cinema and even DJ applications are also possible in 8Ω operation. Supplied with a stand of special design and wall bracket!

100V 8Ω ABS



### ESP-315/SW

Order No. 16.2860

### ESP-315/WS

Order No. 16.2870

2-way PA wall-mount speaker systems

- 100V PA speaker system with an excellent sound
- 2-way system with 10x15cm bass-midrange speaker and 13mm dome tweeter
- Power taps: 15/10/5/2.5W
- Power selector switch with 8Ω operating position
- Can be mounted horizontally or vertically
- Direction of sound radiation can individually be aligned
- Available in black (SW) or white (WS) plastic with respectively lacquered metal grille
- Supplied with wall brackets

100V 8Ω



Model	ESP-6HQ	ESP-315/SW	ESP-315/WS
Frequency range	42-19,000Hz	75-20,000Hz	75-20,000Hz
Power capability, 100V	35/25/15W <sub>RMS</sub>	15/10/5/2.5W <sub>RMS</sub>	15/10/5/2.5W <sub>RMS</sub>
Power capability, 8Ω	180W <sub>MAX</sub> /100W <sub>RMS</sub>	30W <sub>MAX</sub> /15W <sub>RMS</sub>	30W <sub>MAX</sub> /15W <sub>RMS</sub>
SPL (1W/1m)	90dB	90dB	90dB
Max. rated SPL	106dB (110dB/8Ω)	-	-
Admiss. ambient temp.	0-40 °C	0-40 °C	0-40 °C
Dimensions	235x441x337mm	∅ 133mm x 280mm	∅ 133mm x 280mm
Weight	5.8kg	2.1kg	2.1kg
Other features	SPEAKON, par. spring-load. speaker term., mounting bracket, stand, bass-reflex	spring-load. speaker term.	spring-load. speaker term.





**EUL-875/SW**

Order No. 16.2720

PAAR PAIR

**EUL-875/WS**

Order No. 16.2730

PAAR PAIR

**EUL-80/SW**

Order No. 16.1190

PAAR PAIR

**EUL-80/WS**

Order No. 16.1230

PAAR PAIR

**EUL-60/SW**

Order No. 16.1170

PAAR PAIR

**EUL-60/WS**

Order No. 16.1180

PAAR PAIR

**EUL-30/SW**

Order No. 16.1150

PAAR PAIR

**EUL-30/WS**

Order No. 16.1160

PAAR PAIR

**Pairs of universal PA speaker systems**

- 100V line technique, 2-way version
- EUL-875... with high-performance PA speaker with 75W/100V max.
- EUL-80... with 25mm dome tweeter
- EUL-60... and EUL-30... with 11mm dome tweeter
- Excellent sound quality
- 6-step power selector switch
- Black (SW) or white (WS) plastic cabinet
- Movable mounting bracket
- Mounting in corners possible as well due to bevelled shape of cabinets

100V ABS



Model	EUL-875/SW	EUL-875/WS	EUL-80/SW	EUL-80/WS	EUL-60/SW	EUL-60/WS	EUL-30/SW	EUL-30/WS
Frequency range	40-20,000Hz	40-20,000Hz	40-20,000Hz	40-20,000Hz	60-20,000Hz	60-20,000Hz	80-20,000Hz	80-20,000Hz
Power rating (100V)	75/40/25/10/5W <sub>RMS</sub>	75/40/25/10/5W <sub>RMS</sub>	30/15/7.5/4/2W <sub>RMS</sub>	30/15/7.5/4/2W <sub>RMS</sub>	15/7.5/4/2/1W <sub>RMS</sub>	15/7.5/4/2/1W <sub>RMS</sub>	15/7.5/4/2/1W <sub>RMS</sub>	15/7.5/4/2/1W <sub>RMS</sub>
SPL (1W/1m)	89dB	89dB	89dB	89dB	89dB	89dB	87dB	87dB
Max. rated SPL	108dB	108dB	103dB	103dB	100dB	100dB	98dB	98dB
Dimensions	270x370x220mm	270x370x220mm	270x370x220mm	270x370x220mm	215x290x172mm	215x290x172mm	130x192x115mm	130x192x115mm
Weight (piece)	7.2kg	7.2kg	5.4kg	5.4kg	3.4kg	3.4kg	1.4kg	1.4kg
Connections	spr.-load. sp. term.	spr.-load. sp. term.	spr.-load. sp. term.	spr.-load. sp. term.	spr.-load. sp. term.	spr.-load. sp. term.	spr.-load. sp. term.	spr.-load. sp. term.
Mounting facility	movable	movable	movable	movable	movable	movable	movable	movable
	mounting bracket	mounting bracket	mounting bracket	mounting bracket	mounting bracket	mounting bracket	mounting bracket	mounting bracket
System	bass-reflex	bass-reflex	bass-reflex	bass-reflex	bass-reflex	bass-reflex		

### ESP-250/WS

Order No. 16.2780

### ESP-230/WS

Order No. 19.0010

### ESP-215/WS

Order No. 19.9990



**Weatherproof PA speaker systems**, in a white plastic cabinet with protective aluminium grille.

- 100V line technique
- Hose-proof
- Switchable to 8Ω operation
- 5 power taps, 8Ω connection and 100V power selector switch
- 2-way system
- Stainless steel mounting bracket



**100V 8Ω ABS Weather**

Model	ESP-250/WS	ESP-230/WS	ESP-215/WS
Frequency range	80-20,000Hz	80-20,000Hz	100-20,000Hz
Power capability, 100V	50/40/30/20/10W <sub>RMS</sub>	30/20/10/5/2.5W <sub>RMS</sub>	15/10/5/2.5/1.5W <sub>RMS</sub>
Power capability, 8Ω	50W <sub>RMS</sub> /100W <sub>MAX</sub>	50W <sub>RMS</sub> /100W <sub>MAX</sub>	30W <sub>RMS</sub> /60W <sub>MAX</sub>
SPL (1W/1m)	92dB	92dB	87dB
Admiss. ambient temp.	0-40 °C	0-40 °C	0-40 °C
Dimensions	157x260x170mm	157x260x170mm	98x195x105mm
Weight	2.5kg	1.8kg	0.85kg
Other features	spring-load. speaker term.	spring-load. speaker term.	spring-load. speaker term.

### ESP-232/SW

Order No. 16.2600

### ESP-232/WS

Order No. 16.2610



**Weatherproof 2-way PA wall-mount speaker systems**

- 100V PA speaker system with an excellent sound
- 13cm polypropylene bass-midrange speaker and dome tweeter
- 4 power taps
- Power selector switch with 8Ω operating position
- Excellent efficiency for a speaker of such a compact size
- Available in black (SW) or white (WS) plastic with respectively lacquered aluminium grille, modern design
- Supplied with matching metal wall brackets



**100V 8Ω ABS Weather**

Model	ESP-232/SW	ESP-232/WS
Frequency range	75-20,000Hz	75-20,000Hz
Power capability, 100V	30/20/10/5W <sub>RMS</sub>	30/20/10/5W <sub>RMS</sub>
Power capability, 8Ω	50W <sub>MAX</sub> /30W <sub>RMS</sub>	50W <sub>MAX</sub> /30W <sub>RMS</sub>
SPL (1W/1m)	89dB	89dB
Admiss. ambient temp.	0-40 °C	0-40 °C
Dimensions	160x260x180mm	160x260x180mm
Weight	2.3kg	2.3kg
Other features	spring-load. speaker term.	spring-load. speaker term.

**EUL-10**

Order No. 16.0330

**EUL-10/WS**

Order No. 16.0850

**Universal PA speaker systems**

- 100V line technique, 2-way version
- Excellent sound quality
- 5-step power selector switch
- Diecast metal cabinet with black (EUL-10) or white (EUL-10/WS) textured coating, including protective metal grille
- Movable mounting bracket



100V Metal

Model	EUL-10	EUL-10/WS
Frequency range	60-18,000Hz	60-18,000Hz
Power rating	10/5/2.5/1.25W <sub>RMS</sub>	10/5/2.5/1.25W <sub>RMS</sub>
Dimensions	220x118x115mm	220x118x115mm
Weight	2.2kg	2.2kg

Controls on the left side of the cabinet.



**EUL-42/SW**

Order No. 16.1960

**EUL-42/WS**

Order No. 16.1970

PAIR PAIR

PAIR PAIR

**Pairs of universal PA speaker systems**

- 100V line technique, 2-way version
- Black (SW) or white (WS) plastic cabinet with metal front grille
- Integrated suspension device for wall mounting
- Movable mounting bracket



100V

**EUL-75/WS**

Order No. 16.2500

**PA speaker system**

- 100V line technique
- 6-step power selector switch
- HiFi full range speaker
- Excellent sound quality
- White grained wooden cabinet with metal front grille
- Standing speaker with wall holder

100V Wood

Model	EUL-42/SW	EUL-42/WS	EUL-75/WS
Frequency range	80-18,000Hz	80-18,000Hz	70-18,000Hz
Power rating (100V)	10/5/2.5W <sub>RMS</sub>	10/5/2.5W <sub>RMS</sub>	10/5/2.5/1.25/0.625W <sub>RMS</sub>
SPL (1W/1m)	87dB	87dB	86dB
Max. rated SPL	97dB	97dB	96dB
Dimensions	150x95x82mm	150x95x82mm	180x290x170mm
Weight (piece)	960g	960g	3.8kg
Connections	spring-load. speaker term.	spring-load. speaker term.	spring-load. speaker term.
Mounting facility	2 x 1-hole wall holder 2 x 5mm thread for mounting bracket	2 x 1-hole wall holder 2 x 5mm thread for mounting bracket	1 x wall holder
System	2-way	2-way	130



With the 2-way active systems and the subwoofers of the SOUND series, IMG Stage Line provides efficient speakers with a powerful sound which are available in different sizes and with different features. The speaker systems are ideally suited for the application as active HiFi speaker systems, high-end PC speakers or e.g. for media presentations. Due to the linear and neutral tuning, very well-suited as a monitor for home recordings.

### SOUND-65/SW

Order No. 25.0680



Pair of high-quality active speakers, 2 x 80W<sub>MAX</sub>, 2 x 50W<sub>RMS</sub> (30 + 20W each speaker system)

- 2-way active switching for each speaker system with separate power amplifiers for bass speaker and tweeter (bi-amping)
- High-quality bass-reflex MDF cabinet with black lacquered surface
- 16cm bass-midrange speaker with glass fibre cone and 25mm soft dome tweeter
- Due to a switchable adjustment of the tweeter power amplifier, a fine adjustment of the tweeter level is possible without any losses in the level (-2/-1/0/+1dB)
- Each speaker system is equipped with an unbalanced RCA input, a balanced XLR input and a jack input (6.3mm) which can all be adjusted via gain control

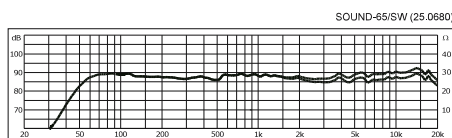

Model	SOUND-65/SW
Frequency range	42-20,000Hz
Amplifier power	80W <sub>MAX</sub> , 50W <sub>RMS</sub> (each speaker system)
Inputs	720mV/10kΩ (bal.) 720mV/7.7kΩ (unbal.)
SPL (1W/1m)	86dB
Max. rated SPL	102dB
Admiss. ambient temp.	0-40 °C
Power supply	230V~/50Hz/120VA
Dimensions (WxHxD)	230x325x275mm
Weight	2 x 7.8kg
<b>Connections</b>	1 x RCA, unbal., IN (each sp. system) 1 x XLR, bal., IN (each sp. system) 1 x 6.3mm jack, bal., IN (each sp. system)

#### Beat 01/2010

"For home recordings or AV presentations, as a monitor speaker for audio and video editing or as a high-quality PC speaker, the SOUND-65/SW offers a price-performance ratio which is almost unbeatable."

### SOUND-40/SW

Order No. 25.0720



Pair of compact active speakers, 2 x 40W<sub>MAX</sub>, 2 x 20W<sub>RMS</sub>

- Active system with 2-channel amplifier in one of the speaker systems and connection of the second passive speaker system to this amplifier
- Beside the variable input sensitivity, the amplifier features a bass control and a treble control
- High-quality bass-reflex MDF cabinet (body in black veneer look, front with black lacquered surface)
- 10cm bass-midrange speaker with glass fibre cone and 25mm soft dome tweeter
- Stereo RCA input and stereo jack input (6.3mm)

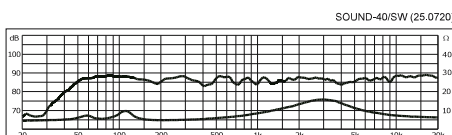

Model	SOUND-40/SW
Frequency range	50-20,000Hz
Amplifier power	40W <sub>MAX</sub> , 20W <sub>RMS</sub> (each sp. system)
Inputs	350mV/16kΩ (unbal.)
SPL (1W/1m)	85dB
Max. rated SPL	98dB
Admiss. amb. temp.	0-40 °C
Power supply	230V~/50Hz/90VA
Dim. (WxHxD)	170x240x195mm (active) 170x240x180mm (slave)
Weight	4.4kg (active) 2.5kg (slave)
<b>Connections</b>	1 x RCA (L/R), unbal., IN 1 x 6.3mm jack (stereo), unbal., IN

#### Beat 02/2011

"With regard to the sound, the SOUND-40/SW outclasses most of the desktop speaker systems. It is not only suitable for AV presentations, as a monitor for audio and video editing or as a high-quality PC speaker, but also provides an excellent performance as an entry-level studio monitor."

**SOUND-100SUB**

Order No. 25.0730



Active subwoofer system, 200W<sub>MAX</sub>, 120W<sub>RMS</sub>

- Active subwoofer providing a pulsed sound and a good bass response for adding to the active SOUND speaker systems, but also to any other compact speaker for HiFi applications, home cinema applications or home recordings
- Beside the variable input sensitivity, a phase switch and an automatic switch-on system which can additionally be activated, the amplifier features an adjustable crossover frequency (50-150Hz)
- High-quality bass-reflex MDF cabinet (black veneer look)
- 25cm (10") bass speaker
- Volume control for the subwoofer
- Inputs via 1 x RCA L/R, RCA LFE or screw terminals for high-level L/R
- Additional outputs for mid-high range speakers, thus well-suited for the connection to already existing speaker cables

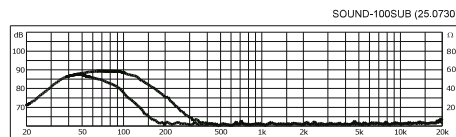

**MKA-80SET/SW**

Order No. 13.1600



**MKA-80SET/WS**

Order No. 13.1610



Active 2-way stereo speaker systems, 2 x 30W<sub>MAX</sub>, 2 x 20W<sub>RMS</sub>

- The set consists of one active speaker system and one passive speaker system. The passive speaker system is connected to the active speaker system via spring-loaded speaker terminals
- Active speaker system with integrated 2-channel amplifier, stereo RCA input, volume control, 2-way tone control, built-in PSU and removable mains cable with shrouded 3-pin IEC plug
- 20cm (8") bass speaker system and dome tweeter
- Black (SW) or white (WS) plastic cabinet
- Movable mounting bracket



1x ACTIVE  
1x PASSIVE

Active ABS

Model	SOUND-100SUB	MKA-80SET/SW	MKA-80SET/WS
Frequency range	35-100Hz	35-20,000Hz	35-20,000Hz
Amplifier power	200W <sub>MAX</sub> , 120W <sub>RMS</sub>	2 x 30W <sub>MAX</sub> /2 x 20W <sub>RMS</sub>	2 x 30W <sub>MAX</sub> /2 x 20W <sub>RMS</sub>
Inputs	150mV/24kΩ (RCA L/R) 55mV/16kΩ (RCA mono) 2.3V/440Ω (high IN)	400mV/10kΩ	400mV/10kΩ
SPL (1W/1m)	88dB	89dB each speaker system	89dB each speaker system
Max. rated SPL	108dB	102dB each speaker system	102dB each speaker system
Admiss. ambient temp.	0-40 °C	0-40 °C	0-40 °C
Power supply	230V~/50Hz/240VA	230V~/50Hz/100VA	230V~/50Hz/100VA
Dimensions (WxHxD)	330x360x360mm	270x365x220mm	270x365x220mm
Weight	13kg	14kg (pair)	14kg (pair)
Connections	1 x RCA (L/R), unbal., IN 1 x RCA (mono), unbal., IN 1 x screw terminal (stereo), high-level IN 1 x screw terminal (stereo), high-level OUT	1 x RCA L/R (active speaker system only) spring-load. speaker term. (link) (both speaker systems)	1 x RCA L/R (active speaker system only) spring-load. speaker term. (link) (both speaker systems)

### MKA-60SET/SW

Order No. 13.1580

### MKA-60SET/WS

Order No. 13.1590



Active 2-way stereo speaker systems,  
2 x 25W<sub>MAX</sub>, 2 x 15W<sub>RMS</sub>

- The set consists of one active speaker system and one passive speaker system. The passive speaker system is connected to the active speaker system via spring-loaded speaker terminals
- Active speaker system with integrated 2-channel amplifier, stereo RCA input, volume control and 2-way tone control, built-in PSU with 3-pin IEC jack
- 16cm (6½") bass speaker system and dome tweeter
- Black (SW) or white (WS) plastic cabinet
- Movable mounting bracket



### MKA-60/SW

Order No. 13.1670

### MKA-60/WS

Order No. 13.1680



Active 2-way speaker systems, 25W<sub>MAX</sub>, 15W<sub>RMS</sub>

- Active speaker system with integrated amplifier, bal. XLR feed-through input, volume control, 2-way tone control and built-in PSU
- 16cm (6½") bass speaker system and dome tweeter
- Black (SW) or white (WS) plastic cabinet
- Movable mounting bracket



Active ABS

### MKA-40SET/SW

Order No. 13.2240



Compact active 2-way stereo speaker system, 2 x 15W<sub>MAX</sub>, 2 x 10W<sub>RMS</sub>

Active speaker system of a compact size with a good sound quality. Suitable for general applications, e.g. media presentations with moderate level requirements or as high-quality PC speakers.

- The set consists of one active speaker system and one passive speaker system (bass-reflex system)
- The passive speaker system is connected to the active speaker system via spring-loaded speaker terminals
- Active speaker system with integrated 2-channel amplifier, stereo RCA input, volume control and 2-way tone control
- Magnetic shielding
- 10cm (4") bass system, magnetically shielded and dome tweeter with neodymium magnet
- Black plastic cabinet
- Two 6.3mm threaded inserts (¼") at the bottom
- Supplied with external PSU



Model	MKA-60SET/SW	MKA-60SET/WS	MKA-60/SW	MKA-60/WS	MKA-40SET/SW
Frequency range	45-20,000Hz	45-20,000Hz	45-20,000Hz	45-20,000Hz	70-20,000Hz
Amplifier power	2 x 25W <sub>MAX</sub> /2 x 15W <sub>RMS</sub>	2 x 25W <sub>MAX</sub> /2 x 15W <sub>RMS</sub>	25W <sub>MAX</sub> /15W <sub>RMS</sub>	25W <sub>MAX</sub> /15W <sub>RMS</sub>	2 x 15W <sub>MAX</sub> , 2 x 10W <sub>RMS</sub>
Inputs	400mV/10kΩ	400mV/10kΩ	250mV/10kΩ	250mV/10kΩ	650mV/4.5kΩ (unbal.)
SPL (1W/1m)	89dB each speaker system	89dB each speaker system	89dB	89dB	87dB
Max. rated SPL	100dB each speaker system	100dB each speaker system	100dB	100dB	97dB
Admiss. ambient temp.	0-40 °C	0-40 °C	0-40 °C	0-40 °C	0-40 °C
Power supply	230V~/50Hz/75VA	230V~/50Hz/75VA	230V~/50Hz/40VA	230V~/50Hz/40VA	24V=/1.5A via suppl. PSU
Dimensions (WxHxD)	220x293x170mm	220x293x170mm	220x293x170mm	220x293x170mm	133x206x128mm
Weight	8kg (pair)	8kg (pair)	4.2kg	4.2kg	3.6kg (pair)
Connections	1 x RCA L/R (active sp. system only) spr.-load. sp. term. (link) (both speaker systems)	1 x RCA L/R (active sp. system only) spr.-load. sp. term. (link) (both speaker systems)	XLR in/out, bal. RCA in/out	XLR in/out, bal. RCA in/out	1 x RCA L/R (active sp. system only) spr.-load. sp. term. (link) (both speaker systems)

**MKS-288TM/WS**

Order No. 13.2180



Pair of PA speaker systems, for traverse and tube mounting, 100W<sub>MAX</sub>, 50W<sub>RMS</sub> each speaker system

2-way speaker systems in an ABS cabinet of functional design and solid diecast support for mounting to tubes with a diameter 35-50mm, 20cm (8") bass speaker and coaxially integrated dome tweeter, neutral sound with a high level stability, suitable for near field PA applications and medium distances of up to 10 metres (background music and PA voice applications/announcements). The MKS-288TM/WS meets the requirements of tasks such as PA applications at exhibitions, presentations and applications on small stages in such a convenient and professional way, it is almost unparalleled in this segment of compact speakers. Connections: solid screw terminals, also suitable for banana plugs. Supplied with safety rope.



Model	MKS-288TM/WS
Music power	100W <sub>MAX</sub>
Power rating	50W <sub>RMS</sub>
Max. frequency range	65-20,000Hz
Impedance	8Ω
SPL (1W/1m)	87dB
Max. rated SPL	104dB
Dimensions	255x355x245mm
Weight	5.6kg
Connections	speaker screw terminal
Mounting facility	tube mounting bracket (ø 35-50mm)

State-of-the-art speaker systems of an appealing design with high-quality speaker technology: these new MKS speaker systems are suitable for all stationary PA applications where a powerful sound and outstanding level reserves are required.

**MKS-8PRO**

Order No. 13.1770



Pair of high-performance PA speakers, 180W<sub>MAX</sub>, 100W<sub>RMS</sub> each speaker system

2-way speaker systems, each in an ABS cabinet (bass-reflex) of modern design, 20cm bass speaker and dome tweeter. Both the sound with a very extended frequency response and the volume capability are absolutely convincing. These units are valuable solutions for PA applications in function rooms or conference rooms, for presentations and on parties. Supplied with mounting brackets for wall mounting.

8Ω ABS

**MKS-6PRO**

Order No. 13.1760



Pair of high-performance PA speakers, 150W<sub>MAX</sub>, 80W<sub>RMS</sub> each speaker system

2-way speaker systems, each in an ABS cabinet (bass-reflex) of modern design, 16cm bass speaker and dome tweeter. A convincing sound for most varying music, the volume capability is outstanding due to the excellent efficiency. The MKS-6PRO is a perfect solution for PA applications in function rooms or conference rooms and for presentations. Supplied with mounting brackets.

8Ω ABS



Model	MKS-8PRO	MKS-6PRO
Music power	180W <sub>MAX</sub>	150W <sub>MAX</sub>
Power rating	100W <sub>RMS</sub>	80W <sub>RMS</sub>
Max. frequency range	40-21,000Hz	45-21,000Hz
Impedance	8Ω	8Ω
SPL (1W/1m)	91dB	93dB
Max. rated SPL	111dB	112dB
Dimensions	265x374x285mm	230x350x240mm
Weight	5.7kg	4.5kg
Connections	speaker screw terminal	speaker screw terminal
Mounting facility	mounting bracket	mounting bracket

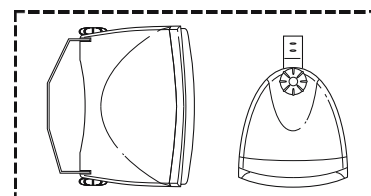

### MKS-88/SW

Order No. 13.1150

### MKS-88/WS

Order No. 13.1160

### MKS-64/SW

Order No. 13.1130

### MKS-64/WS

Order No. 13.1140

### MKS-34/SW

Order No. 13.1110

### MKS-34/WS

Order No. 13.1120



#### Pairs of 2-way speaker systems

- MKS-88... in 8Ω, MKS-64... and MKS-34... in 4Ω
- Dome tweeter
- Excellent sound quality
- Black (SW) or white (WS) plastic cabinet
- Movable mounting bracket
- Mounting in corners possible as well due to bevelled shape of cabinets



4Ω/8Ω ABS

Model	MKS-88/SW	MKS-88/WS	MKS-64/SW	MKS-64/WS	MKS-34/SW	MKS-34/WS
Music power	125W <sub>MAX</sub>	125W <sub>MAX</sub>	90W <sub>MAX</sub>	90W <sub>MAX</sub>	45W <sub>MAX</sub>	45W <sub>MAX</sub>
Power rating	85W <sub>RMS</sub>	85W <sub>RMS</sub>	60W <sub>RMS</sub>	60W <sub>RMS</sub>	30W <sub>RMS</sub>	30W <sub>RMS</sub>
Max. frequency range	40-20,000Hz	40-20,000Hz	60-20,000Hz	60-20,000Hz	80-20,000Hz	80-20,000Hz
Impedance	8Ω	8Ω	4Ω	4Ω	4Ω	4Ω
SPL (1W/1m)	89dB	89dB	89dB	89dB	87dB	87dB
Max. rated SPL	107dB	107dB	106dB	106dB	101dB	101dB
Dimensions	270x370x220mm	270x370x220mm	215x290x172mm	215x290x172mm	130x192x115mm	130x192x115mm
Weight	5.4kg	5.4kg	3.4kg	3.4kg	1.3kg	1.3kg
Connections	speaker screw terminal	speaker screw terminal	speaker screw terminal	speaker screw terminal	spring-load. speaker term.	spring-load. speaker term.
Mounting facility	2 x M6 thread	2 x M6 thread	2 x M6 thread	2 x M6 thread	for wall hooks	for wall hooks



**MKS-248/WS**

Order No. 13.2050



**Pair of 2-way wall-mount design speaker systems, 100W<sub>MAX</sub>, 8Ω**

High-performance PA speaker systems (bass-reflex) of a top design with a perfect sound, each equipped with 2 x 10cm polypropylene bass-midrange speaker and one high-quality dome tweeter. With an adequate number of the speaker systems, the good efficiency and the high power capability allow clearly increased volume levels. The sound quality even meets HiFi requirements. Available in white plastic with matching lacquered aluminium grille. Supplied with a matching metal wall bracket (movable and tiltable).



**8Ω ABS**

Model	MKS-248/WS
Impedance	8Ω
Frequency range	70-20,000Hz
Crossover frequency	4,000Hz
Power rating	100W <sub>MAX</sub> , 60W <sub>RMS</sub>
SPL (1W/1m)	89dB
Dimensions	150x300x190mm
Weight	3.4kg
Other features	

**MKS-232/SW**

Order No. 13.2160



**MKS-232/WS**

Order No. 13.2170



**Weatherproof pairs of 2-way wall-mount speaker systems, 50W<sub>MAX</sub>, 8Ω**

PA speaker systems with an excellent sound, 13cm polypropylene bass-midrange speaker and dome tweeter. Excellent efficiency for speakers of such a compact size. Available in black (SW) or white (WS) plastic with respectively lacquered aluminium grille, modern design. Supplied with matching metal wall brackets.



**8Ω ABS Weather**

Model	MKS-232/SW	MKS-232/WS
Music power	50W <sub>MAX</sub>	50W <sub>MAX</sub>
Power rating	30W <sub>RMS</sub>	30W <sub>RMS</sub>
Max. frequency range	75-20,000Hz	75-20,000Hz
Impedance	8Ω	8Ω
SPL (1W/1m)	89dB	89dB
Max. rated SPL	103dB	103dB
Dimensions	160x260x180mm	160x260x180mm
Weight	1.8kg	1.8kg
Connections	spring-load, speaker term.	speaker screw terminal
Mounting facility	mounting bracket	mounting bracket

### MKS-75/WS

Order No. 13.2120



Speaker system, 50<sub>MAX</sub>, 4Ω

- HiFi full range speaker
- Excellent sound quality
- White grained wooden cabinet
- Metal front grille with integrated high-quality volume control
- Standing speaker with wall holder



4Ω Wood

Model	MKS-75/WS
Music power	50W <sub>MAX</sub>
Power rating	25W <sub>RMS</sub>
Max. frequency range	70-18,000Hz
Impedance	4Ω
SPL (1W/1m)	86dB
Max. rated SPL	101dB
Dimensions	180x290x170mm
Weight	3.7kg
Connections	spring-load. speaker term.
Mounting facility	1 x wall holder

### MKS-48/WS

Order No. 13.2130



Pair of wall/ceiling/corner mount speaker systems, 30W<sub>MAX</sub>, 8Ω

These really universally mountable speakers allow a perfect integration into most versatile indoor mounting positions. Interesting possibilities due to the optional creation of a cluster with 1-4 elements, from ceiling suspension in a corner to a hemisphere of wide radiation in the middle of the wall or ceiling. The sound of the pure white speakers is adjusted in such a precise way that it provides a complete sound of high quality, no matter in which position the speakers are placed.

- White ABS cabinet
- High-quality 10cm full range speaker
- Variable support and mounting system

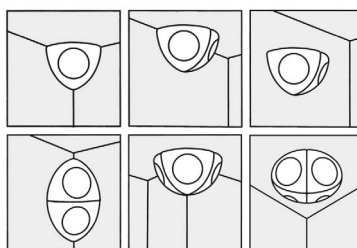

8Ω ABS

### MKS-42/SW

Order No. 13.1520



### MKS-42/WS

Order No. 13.1530





Pairs of universal 2-way speaker systems, 4Ω

- Black (SW) or white (WS) plastic cabinet with metal front grille
- Integrated holder for wall mounting
- Movable mounting bracket



4Ω ABS



Model	MKS-48/WS	MKS-42/SW	MKS-42/WS
Impedance	8Ω	4Ω	4Ω
Frequency range	100-20,000Hz	80-18,000Hz	80-18,000Hz
Crossover frequency	-	-	-
Power rating	30W <sub>MAX</sub> , 15W <sub>RMS</sub>	40W <sub>MAX</sub> , 20W <sub>RMS</sub>	40W <sub>MAX</sub> , 20W <sub>RMS</sub>
SPL (1W/1m)	87dB	87dB	87dB
Dimensions	195x145x140mm	150x95x82mm	150x95x82mm
Weight	1.5kg	1.4kg	1.4kg
Other features		spring-load. speaker term., 2 x 1-hole wall holder	spring-load. speaker term., 2 x 1-hole wall holder

**ETS-240TW/WS**   **NEW.**  
 Order No. 16.2960

**ETS-220TW/WS**   **NEW.**  
 Order No. 16.2950

**ETS-210TW/WS**   **NEW.**  
 Order No. 16.2940

- PA column speakers**, in extruded aluminium cabinets.
- Weatherproof and hose-proof
  - 100V line technique
  - 2-way version (with additional integrated tweeters for a clearly improved sound)
  - Connection cable with 5-step power taps
  - 2 x M6 thread
  - Aluminium front grille
  - Supplied with mounting brackets

100V Aluminium Weather Tweeter

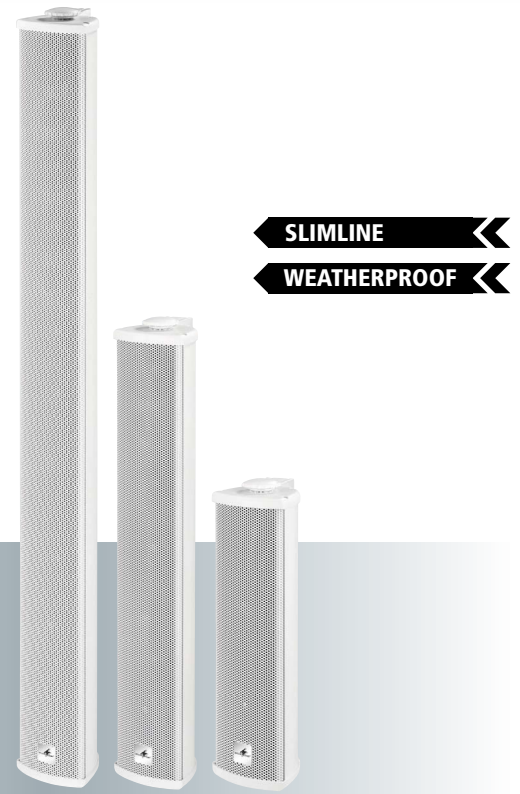

**ETS-440TW/WS**   **NEW.**  
 Order No. 16.2550

**ETS-420TW/WS**   **NEW.**  
 Order No. 16.2330

**ETS-410TW/WS**   **NEW.**  
 Order No. 16.2320

- Weatherproof PA column speakers**, with a top-quality sound.
- Weatherproof and hose-proof, in an extruded aluminium cabinet
  - 100V line technique
  - 2-way version (with additional integrated tweeter for a clearly improved sound)
  - Integrated crossover network
  - Aluminium front grille
  - Supplied with a robust tiltable and movable aluminium wall brackets
  - Connection via cable with 4 power taps

100V Aluminium Weather Tweeter

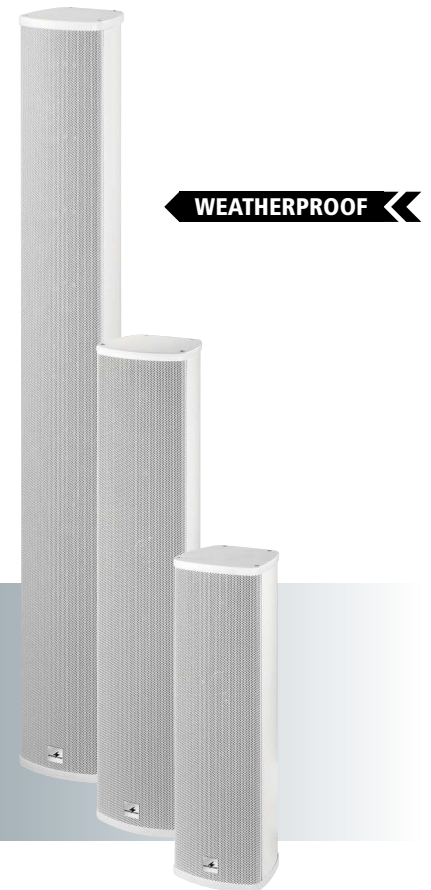

Model	ETS-240TW/WS	ETS-220TW/WS	ETS-210TW/WS	ETS-440TW/WS	ETS-420TW/WS	ETS-410TW/WS
Frequency range	150-20,000Hz	150-20,000Hz	170-20,000Hz	90-20,000Hz	90-19,000Hz	100-19,000Hz
Number of speakers	8+4	4+2	2+1	8+1	4+1	2+1
Power rating	40/30/20/10/5W <sub>RMS</sub>	20/10/5/2.5/1.25W <sub>RMS</sub>	10/5/2.5/1.25/0.63W <sub>RMS</sub>	40/20/10/5W <sub>RMS</sub>	20/10/5/2.5W <sub>RMS</sub>	10/5/2.5/1.25W <sub>RMS</sub>
SPL (1W/1m)	90dB	89dB	86dB	95dB	97dB	94dB
Dimensions	80x846x70mm	80x469x70mm	80x280x70mm	121x965x109mm	121x570x109mm	121x380x109mm
Weight	2.8kg	1.7kg	1kg	7.5kg	4.6kg	3kg

### ETS-230TW/WS

Order No. 16.2110

### ETS-215TW/WS

Order No. 16.2100

**PA column speakers**, in extruded aluminium cabinets, with top and bottom plates of aluminium.

- 100V line technique
- 2-way version (with additional integrated tweeters for a clearly improved sound)
- Integrated crossover network
- 5-step power selector switch
- 2 x M6 thread
- Metal front grille
- Supplied with mounting brackets
- Connection via cable, 2 cores

**ETS-230TW/WS with 4 tweeters**

**ETS-215TW/WS with 2 tweeters**

**100V Aluminium Tweeter**

### ETS-230/WS

Order No. 16.1310

### ETS-215/WS

Order No. 16.1300

**PA column speakers**, in extruded aluminium cabinets, with top and bottom plates of aluminium.

- 100V line technique
- 5-step power selector switch
- 2 x M6 thread
- Metal front grille
- Supplied with mounting brackets
- Connection via cable, 2 cores

**100V Aluminium**



Model	ETS-230TW/WS	ETS-215TW/WS	ETS-230/WS	ETS-215/WS
Frequency range	200-20,000Hz	250-20,000Hz	200-15,000Hz	250-15,000Hz
Number of speakers	8+4	4+2	8	4
Power rating	20/10/5/2.5W <sub>RMS</sub>	12/6/3/1.5W <sub>RMS</sub>	30/15/7.5/3.75W <sub>RMS</sub>	15/7.5/3.75/2W <sub>RMS</sub>
SPL (1W/1m)	94dB	90dB	95dB	92dB
Dimensions	105x700x75mm	105x410x75mm	105x687x85mm	105x405x85mm
Weight	4.2kg	2.6kg	4.1kg	2.5kg

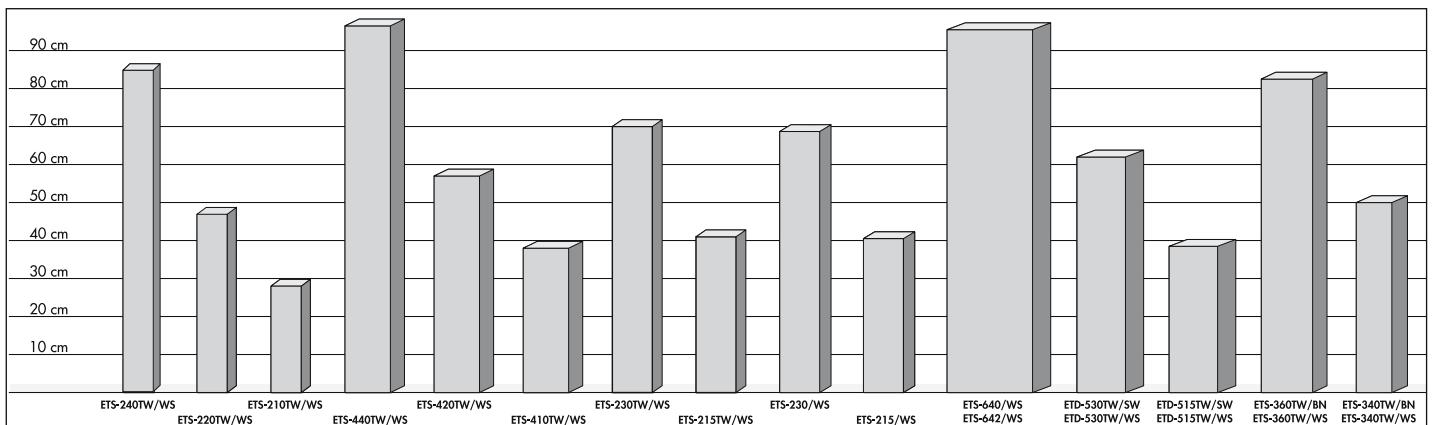

**ETS-640/WS**

Order No. 16.1350



**Weatherproof PA column speaker**, in an extruded aluminium cabinet, with top and bottom plates of aluminium.

- Splashproof

**ETS-642/WS**

Order No. 16.1590

**PA column speaker**, in an extruded aluminium cabinet, with top and bottom plates of aluminium.

- Brilliant sound due to 2-way technique
- 100V line technique
- Connection cable with 4 power taps
- 2 x M8 thread
- Aluminium front grille
- Supplied with mounting brackets
- Connection via cable with 4 power taps

**100V Aluminium Tweeter**

Model	ETS-640/WS	ETS-642/WS
Frequency range	140-6,000Hz	125-12,000Hz
Number of speakers	4	4
Power rating	40/20/10/5W <sub>RMS</sub>	40/20/10/5W <sub>RMS</sub>
SPL (1W/1m)	97dB	100dB
Dimensions	225x955x145mm	225x955x145mm
Weight	8.5kg	8.4kg

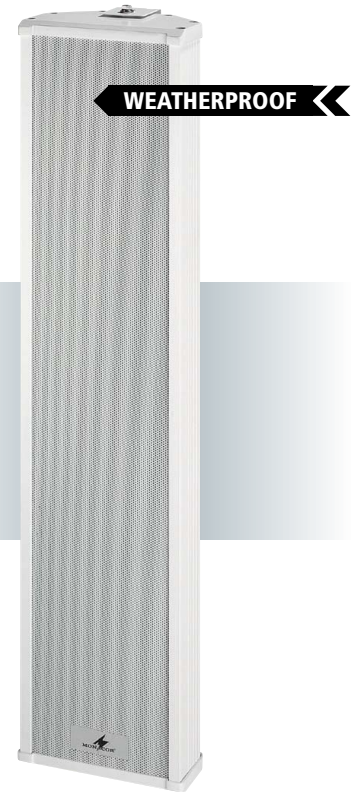

**ETS-530TW/SW**

Order No. 16.2650

**ETS-530TW/WS**

Order No. 16.2660

**ETS-515TW/SW**

Order No. 16.2620

**ETS-515TW/WS**

Order No. 16.2630

**PA column speakers**

- 100V line technique or 8Ω operation
- 2-way version (with additional integrated tweeter for a clearly improved sound)
- Integrated crossover network
- 6-step power selector switch with 8Ω switching
- 2 x M6 threaded jack
- Plastic cabinet and protective metal grille in black (SW) or white (WS)
- Supplied with mounting bracket
- Connection via spring-loaded speaker terminal

**100V/8Ω Plastic Tweeter**



Model	ETS-530TW/SW	ETS-530TW/WS	ETS-515TW/SW	ETS-515TW/WS
Frequency range	85-20,000Hz	85-20,000Hz	90-20,000Hz	90-20,000Hz
Number of speakers	4+1	4+1	2+1	2+1
Power rating	30/15/7.5/4/2W <sub>RMS</sub> (100V) 60W <sub>MAX</sub> /30W <sub>RMS</sub> (8Ω)	30/15/7.5/4/2W <sub>RMS</sub> (100V) 60W <sub>MAX</sub> /30W <sub>RMS</sub> (8Ω)	15/7.5/4/2/1W <sub>RMS</sub> (100V) 30W <sub>MAX</sub> /15W <sub>RMS</sub> (8Ω)	15/7.5/4/2/1W <sub>RMS</sub> (100V) 30W <sub>MAX</sub> /15W <sub>RMS</sub> (8Ω)
SPL (1W/1m)	89dB	89dB	87dB	87dB
Dimensions	128x620x140mm	128x620x140mm	128x385x140mm	128x385x140mm
Weight	5kg	5kg	3.5kg	3.5kg

The new generation of column speakers from MONACOR: all the advantages of a column speaker (shape, directional characteristic and mounting) are now combined with an excellent sound quality and a particularly high level stability. With the 2-way ETS speakers in a wooden cabinet (BN: high-quality decorative wood design, WS: white decorative surface with wood pattern), most varying requirements can be met by these speaker systems, like a very good speech intelligibility and at the same time an optimised music reproduction of the full range.

**ETS-360TW/BN**   
Order No. 16.2260

**ETS-360TW/WS**   
Order No. 16.2270

**High-end column speakers, (indoors), 100V.**

Column speakers in a wooden cabinet of compact size, coated with high-quality foils in decorative wood pattern (BN: natural brown, WS: white with structured wood pattern), 2½-way technology with movable tweeter (25mm textile dome), clearly extended frequency range compared with standard full range column speakers. The ETS-360... speakers impress by an enormously dynamic and complete sound which is convincing due to a good speech intelligibility and a surprisingly great sound also at higher volume levels.

- 2 bass speakers, 4 bass-midrange speakers, 1 tweeter
- Spring-loaded terminals with 3 power taps
- 2 x M8 thread
- Supplied with mounting brackets
- Metal front grille

100V Wood Tweeter

At PA column speakers with a weight of more than 5kg, both of the supplied mounting brackets must be used for safety reasons!

### PROSOUND 01/2008

"Can be integrated into almost any architectural style without any problems. These speaker systems can be operated somewhere for 20 years without being noticed."

**ETS-340TW/BN**   
Order No. 16.2240

**ETS-340TW/WS**   
Order No. 16.2250

**High-end column speakers, (indoors), 100V**

Column speakers in a wooden cabinet of compact size, coated with high-quality foils in decorative wood pattern (BN: natural brown, WS: white with structured wood pattern), 2½-way technology with movable tweeter (25mm textile dome), clearly extended frequency range compared with standard full range column speakers. The sound is ideally matched to the reproduction of both music and vocals.

- 4 bass speakers, 2 bass-midrange speakers, 1 tweeter
- Spring-loaded terminal with 3 power taps
- 2 x M8 thread
- Supplied with mounting brackets
- Metal front grille

100V Wood Tweeter



Model	ETS-360TW/BN	ETS-360TW/WS	ETS-340TW/BN	ETS-340TW/WS
Frequency range	90-19,000Hz	90-19,000Hz	100-19,000Hz	100-19,000Hz
Number of speakers	6+1	6+1	6+1	6+1
Power rating	60/30/15W <sub>RMS</sub>	60/30/15W <sub>RMS</sub>	40/20/10W <sub>RMS</sub>	40/20/10W <sub>RMS</sub>
SPL (1W/1m)	94dB	94dB	92dB	92dB
Dimensions	135x825x110mm	135x825x110mm	95x500x120mm	95x500x120mm
Weight	7.3kg	7.3kg	3.5kg	3.5kg

## ACCESSORIES



### ETS-1BR

Order No. 11.0680

**Mounting set**, for PA column speakers with adjustable tilting angle.

Consisting of 4 mounting brackets, 4 metal rails and 8 screws (M8 x 12) with matching washers as well as 2 nuts.



### EBH-49

Order No. 12.0270

**Stand adapter**, for PA column speakers.

- Black lacquered steel version
- M8 x 15mm threaded bolt
- For column speakers of the ETS-... series up to 7.5kg max. and with M8 thread



### EBH-47

Order No. 11.1500

**Stand adapter**, e.g. for PA column speakers or small light effect units.

- Matching stands with standard diameter
- Black lacquered steel version
- M8 x 15mm threaded bolt with wing nut
- Max. load: 7.5kg



### ZM-100

Order No. 17.1950



**Impedance meter**, for measuring the impedance (Z) of individual speakers or speaker lines.

Measurement with pulsed 1kHz signal. Processor-controlled and with independent selection of the most favourable measuring range. At the same time, the power received at the mains of the 100V speaker is calculated and displayed. Range button and hold button. Measuring ranges: 200Ω/2kΩ/20kΩ/200kΩ. Power supply via 4 x 1.5V battery AA size. Dimensions: 100x177x50mm. Weight: 570g.

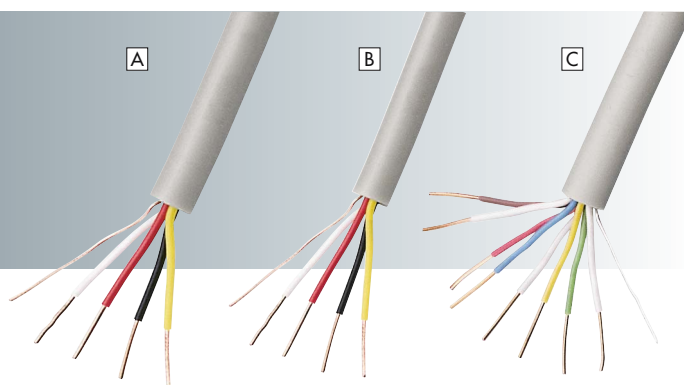
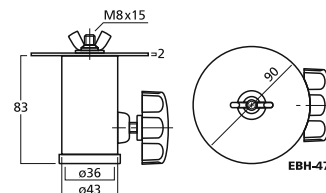
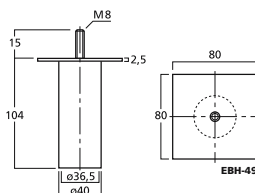

### Signal Cables

For alarm, PA and communication technology.

- 100m coil
- Type J-Y(S)tY acc. to VDE 0815
- Common foil shield
- Copper wires with coloured insulation

JYSTY-2208 is suitable for the wiring of 100V PA systems, cross-section of each core: 0.5mm<sup>2</sup>.



Model	Order No.	Cores	Length	Outside diameter	Colour
JYSTY-2208	11.1340	4 x ø 0.8mm	100m coil	ø 7mm	grey
JYSTY-2206	19.2310	4 x ø 0.6mm	100m coil	ø 5.5mm	grey
JYSTY-4206	19.2320	8 x ø 0.6mm	100m coil	ø 6.5mm	grey

Now available by popular demand: weatherproof PA speakers with IP classification. Exactly the right speakers whenever a high sound quality, high volume capability and a respective strength are required in all weather conditions. Ideally suited for permanent open-air applications, e.g. at fairground attractions, PA applications in pedestrian areas, at sports facilities and wherever a weather-protected installation of the speakers is not possible.

### PAB-120WP/SW

Order No. 25.3750



#### Weatherproof high-performance PA speaker system, 120W<sub>RMS</sub>

- High-performance 2-way bass-reflex system with cabinet made of ABS plastic
- 100V line technique
- 30cm (12") PA bass speaker with impregnated paper cone
- 25mm (1") horn tweeter system
- Very good sound characteristics
- Front grille with water-repellent gauze
- Speaker in and parallel out, additionally screw terminal
- Stainless steel metal parts
- 2 x M10 thread insert each at the top and bottom for suspension
- Stand sleeve

100V ABS Weather



### PAB-12WP/SW

Order No. 25.3740



#### Weatherproof high-performance PA speaker system,

400W<sub>MAX</sub>/200W<sub>RMS</sub>, 8Ω

- High-performance 2-way bass-reflex system with cabinet made of ABS plastic
- 30cm (12") PA bass speaker with impregnated paper cone
- 25mm (1") horn tweeter system
- Very good sound characteristics
- Front grille with water-repellent gauze
- Speaker in and parallel out
- Stainless steel metal parts
- 2 x M10 thread insert each at the top and bottom for suspension
- Stand sleeve

8Ω ABS Weather



Model	PAB-120WP/SW	PAB-12WP/SW
Frequency range	42-20,000Hz	42-20,000Hz
Resonant frequency (fs)	-	-
Power capability, 100V	120/60/30W <sub>RMS</sub>	-
Power capability, 8Ω	-	400W <sub>MAX</sub> , 200W <sub>RMS</sub>
Power capability, 4Ω	-	-
SPL (1W/1m)	98dB	98dB
Max. rated SPL	119dB	121dB
Type of speaker	300	300
Admiss. ambient temp.	0-40 °C	0-40 °C
Dimensions	370x655x410mm	370x655x410mm
Weight	21kg	20kg
Other features	2 x SPEAKER par. in/out screw terminal mounting bracket, bass-reflex	2 x SPEAKER par. in/out bass-reflex



Now available by popular demand: weatherproof PA speakers with IP classification. Exactly the right speakers whenever a high sound quality, high volume capability and a respective strength are required in all weather conditions. Ideally suited for permanent open-air applications, e.g. at fairground attractions, PA applications in pedestrian areas, at sports facilities and wherever a weather-protected installation of the speakers is not possible.

**PAB-82WP/WS**

Order No. 25.3590



**Weatherproof high-performance PA speaker system, 120W<sub>RMS</sub> in 100V operation or up to 240W<sub>MAX</sub>/120W<sub>RMS</sub> in 8Ω operation**

- High-performance 2-way coaxial speaker system with cabinet made of ABS plastic
- 100V operation or 8Ω operation, selectable
- 20cm (8") PA coaxial system with impregnated paper cone
- Coaxially integrated 25mm (1") horn tweeter
- Very good sound characteristics
- Front grille with water-repellent gauze
- Recessed connection terminal with cover plate and high-strength cable gland
- Speaker in and parallel out, screw terminal
- Metal parts and wall bracket made of stainless steel

**100V/8Ω**    **ABS**    **Weather**



**PAB-8WP/WS**

Order No. 25.3570



**Weatherproof high-performance PA speaker system, 120W<sub>RMS</sub> in 100V operation or up to 240W<sub>MAX</sub>/120W<sub>RMS</sub> in 8Ω operation**

- High-performance 2-way bass-reflex system with cabinet made of ABS plastic
- 100V or 8Ω operation, selectable
- 20cm (8") PA bass speaker with impregnated paper cone
- 25mm (1") horn tweeter system
- Very good sound characteristics
- Front grille with water-repellent gauze
- Recessed connection terminal with cover plate and high-strength cable gland
- Speaker in and parallel out, screw terminal
- Metal parts and wall bracket made of stainless steel

**100V/8Ω**    **ABS**    **Weather**



Model	PAB-82WP/WS	PAB-8WP/WS
Frequency range	50-20,000Hz	48-20,000Hz
Resonant frequency (fs)	-	-
Power capability, 100V	120/60/30W <sub>RMS</sub>	120/60/30W <sub>RMS</sub>
Power capability, 8Ω	240W <sub>MAX</sub> , 120W <sub>RMS</sub>	240W <sub>MAX</sub> , 120W <sub>RMS</sub>
Power capability, 4Ω	-	-
SPL (1W/1m)	96dB	96dB
Max. rated SPL	117dB	117dB
Type of speaker	200	200
Admiss. ambient temp.	0-40 °C	0-40 °C
Dimensions	280x280x270mm	240x430x250mm
Weight	9.5kg	13.1kg
Other features	2 x SPEAKER par. in/out screw terminal mounting bracket, bass-reflex	2 x SPEAKER par in/out screw terminal mounting bracket, bass-reflex

### PAB-6WP/WS

Order No. 25.3560



**Weatherproof high-performance PA speaker system, 100W<sub>RMS</sub> in 100V operation or up to 180W<sub>MAX</sub>/100W<sub>RMS</sub> in 8Ω operation**

- Compact 2-way bass-reflex system with cabinet made of ABS plastic
- 100V or 8Ω operation, selectable
- 16cm bass speaker with coated carbon fibre cone
- 30mm dome tweeter with horn front attachment
- Very good sound characteristics
- Front grille with water-repellent gauze
- Recessed connection terminal with cover plate and high-strength cable gland
- Metal parts and wall bracket made of stainless steel

**100V/8Ω**    ABS    Weather



### PAB-52WP/WS

Order No. 25.3580



**Weatherproof high-performance PA speaker system, 50W<sub>RMS</sub> in 100V operation or up to 100W<sub>MAX</sub>/50W<sub>RMS</sub> in 4Ω operation**

- Compact wideband bass-reflex system with cabinet made of ABS plastic
- 100V or 4Ω operation, selectable
- 13cm (5") high-quality full range speaker with aluminium cone
- Very good sound characteristics
- Front grille with water-repellent gauze
- Recessed connection terminal with cover plate and high-strength cable gland
- Metal parts and wall bracket made of stainless steel

**100V/4Ω**    ABS    Weather



Model	PAB-6WP/WS	PAB-52WP/WS
Frequency range	42-19,000Hz	60-18,000Hz
Resonant frequency (fs)	-	-
Power capability, 100V	100/50/25W <sub>RMS</sub>	50/25/12.5W <sub>RMS</sub>
Power capability, 8Ω	180W <sub>MAX</sub> , 100W <sub>RMS</sub>	-
Power capability, 4Ω	-	100W <sub>MAX</sub> , 50W <sub>RMS</sub>
SPL (1W/1m)	90dB	87dB
Max. rated SPL	110dB	104dB
Type of speaker	165	130
Admiss. ambient temp.	0-40 °C	0-40 °C
Dimensions	200x370x240mm	200x200x190mm
Weight	7.1kg	5.1kg
Other features	screw terminal mounting bracket, bass-reflex	screw terminal mounting bracket, bass-reflex

**ESP-270P**

Order No. 24.7010



**PA speaker system**, with black plastic coating.

- 100V line technique
- Switchable to 8Ω operation
- 2-way bass-reflex system with two 18cm (7") bass-midrange speakers and a tweeter horn with ferrofluid
- 4 power taps, 8Ω connection and 100V power selector switch
- Prepared for mounting onto stands with supporting plate

**100V** 8Ω Wood



Model	ESP-270P
Frequency range	50-15,000Hz
Power capability, 100V	50/37.5/25/12.5W <sub>RMS</sub>
Power capability, 8Ω	100W <sub>RMS</sub> /200W <sub>MAX</sub>
SPL (1W/1m)	94dB
Admiss. ambient temp.	0-40 °C
Dimensions	480x290x240mm
Weight	9kg
Other features	6 x screw terminal

**PAB-506/WS**

Order No. 24.3130



**Universal speaker system**, 180W<sub>MAX</sub>, 4Ω

A high-quality mini PA speaker system of highest manufacturing quality, in white (WS), 16cm carbon fibre bass-midrange speaker of long excursion and efficient special dome tweeter with flat horn design, very linear frequency response and fantastic sound with a surprisingly high level stability and very high efficiency for its small size, extra lightweight ABS plastic cabinet, supplied with mounting bracket. Suitable for any small and medium PA application. With additional subwoofer and/or in multiple arrangement, also suitable for DJ and similar applications. The connection terminals (spring-loaded speaker terminals and Speakon) are connected in parallel and can either be used as input or output.

**4Ω** ABS



Model	PAB-506/WS
<b>System</b>	2-way bass-reflex
Bass speaker	16cm (6.5")
Tweeter	horn dome tweeter
<b>Power capabilities</b>	
Music power	180W <sub>MAX</sub>
Power rating	100W <sub>RMS</sub>
<b>General information</b>	
Impedance	4Ω
Frequency range	65-20,000Hz
SPL (1W/1m)	93dB
Max. rated SPL	113dB
Admiss. ambient temp.	0-40 °C
Dimensions	235x385x220mm
Inputs	1 x NEUTRIK SPEAKON 1 x spring-load. speaker term.
Outputs	1 x spring-load. speaker term. 1 x NEUTRIK SPEAKON
Weight	5.9kg

This series of speaker systems including subwoofer from MONACOR sets standards in the modern PA technology: high-quality lacquered cabinets of a perfect design, lightweight but stable and of high power capability, featuring a good sound and a high efficiency. They are available as EUL-2... in the professional 100V technique. Real PA speaker systems which can be used for versatile applications at a particularly favourable price.

### EUL-2

Order No. 17.1250



#### PA speaker system in 100V line technique

Lacquered cabinet, equipped with a 20cm (2 x 8") double bass speaker of high power capability and a dyn. 25mm (1") horn tweeter, well-balanced and dynamic sound, SPEAKON connection, rotary switch for power selection, stand sleeve. A speaker system of an appealing design, fully efficient for speech applications and light music and vastly superior to customary 100V speakers. A subwoofer support is useful for bass reproductions of high requirements (e.g. with EUL-2SUB). This speaker can be integrated into any existing or new 100V system by simply connecting it in parallel, as long as the amplifier features the respective power reserves!

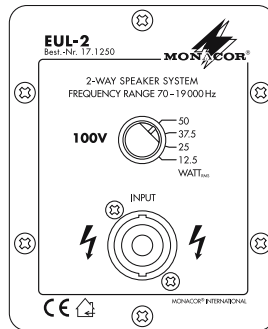

100V MDF

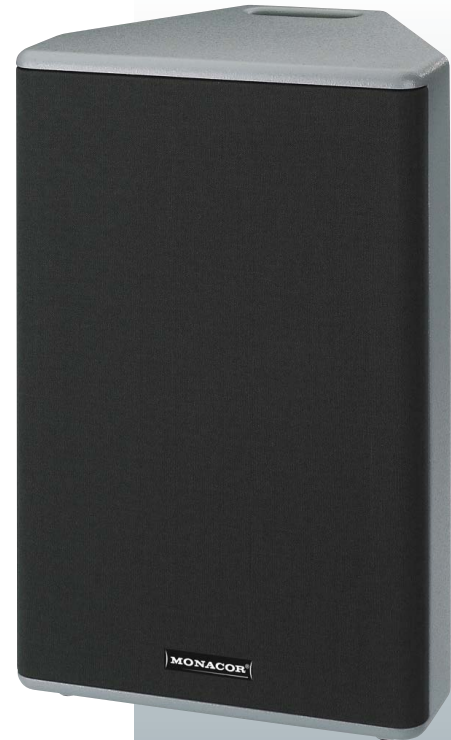

Matching adapter pieces for speaker systems PAST-10/SW (80cm) and PAST-12/SW (100cm) are available at option.

### EUL-2SUB

Order No. 17.1260



#### Innovative PA subwoofer system in 100V line technique

Lacquered cabinet, equipped with a 30cm (12") bass speaker for a deep and dynamic bass reproduction, SPEAKON connections (input and sat out/par. out), stand sleeve, of an appealing design. The high efficiency perfectly matches the EUL-2 but it is also suitable as an addition to many other 100V systems, of course. The built-in crossover network (low-pass) allows a reproduction of bass frequencies which can normally not be located, thus the EUL-2SUB is an ideal solution for numerous 100V systems where the bass reproduction is not powerful enough (e.g. at many column speakers or ceiling speaker systems). The EUL-2SUB can be placed anywhere in the room and simply be connected in parallel to the 100V line, as long as the reserves of the amplifier are sufficient for it.

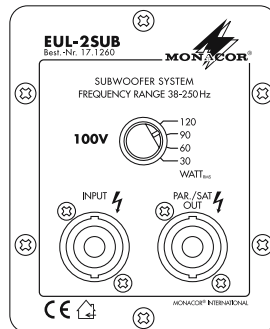

100V MDF



Model	EUL-2	EUL-2SUB
<b>Power capabilities</b>		
100V operation	50/37.5/25/12.5W <sub>RMS</sub>	120/90/60/30W <sub>RMS</sub>
<b>General information</b>		
Frequency range	70-19,000Hz	38-250Hz
SPL (1W/1m)	95dB	95dB
Admiss. ambient temp.	0-40 °C	0-40 °C
Dimensions	320x485x250mm	420x430x445mm
Weight	8.7kg	19.5kg
<b>Connections</b>	1 x SPEAKON	1 x SPEAKON IN, 1 x SPEAKON par. out/sat out

**GLS-201/GR**

Order No. 16.1820



**Weatherproof PA garden speaker "Granite"**, stone look, suitable for general PA applications, e.g. in gardens, hotels, restaurants and pubs.

- 100V line technique
- 20cm (8") high-quality full range speaker with dual cone
- Polypropylene cone
- 5.8m multicore connection cable
- Integrated audio transformer with 3 power taps (25/15/7.5W<sub>RMS</sub>)
- Frequency range: 80-15,000Hz
- SPL (1W/1m): 88dB
- Dimensions (WxHxD): 440x310x320mm (dimensions may slightly vary for manufacturing reasons)
- Weight: 5.7kg

100V	Weather
------	---------

**GLS-200/GR**

Order No. 16.1510



**Weatherproof PA garden speaker "Granite"**, 100W<sub>MAX</sub>, 8Ω, stone look, suitable for general PA applications, e.g. in gardens, hotels, restaurants and pubs.

- 20cm (8") high-quality full range speaker with dual cone
- Polypropylene cone
- Frequency range: 50-16,000Hz
- SPL (1W/1m): 89dB
- Dimensions (WxHxD): 440x310x320mm (dimensions may slightly vary for manufacturing reasons)

8Ω	Weather
----	---------



## Arrangement of Ceiling Speakers

When installing speakers into a ceiling, the question frequently arises where to place the speakers and at what distance. "WHERE" can easily be answered, always where people are staying.

The answer regarding the distance is not as easy. The shorter the distance of the speakers, the lower the individual power can be selected, which will result in a more uniform sound distribution.

Supposed that the persons are sitting down, an average height of the ears of approx. 1.3 m will be obtained. The basic distance can be determined with the following general rule.

Speaker distance =  $2 \times (H - 1.3 \text{ m})$  H = ceiling height

With a ceiling height of 4 m, we get a distance of  $2 \times (4 \text{ m} - 1.3 \text{ m}) = 5.4 \text{ m}$

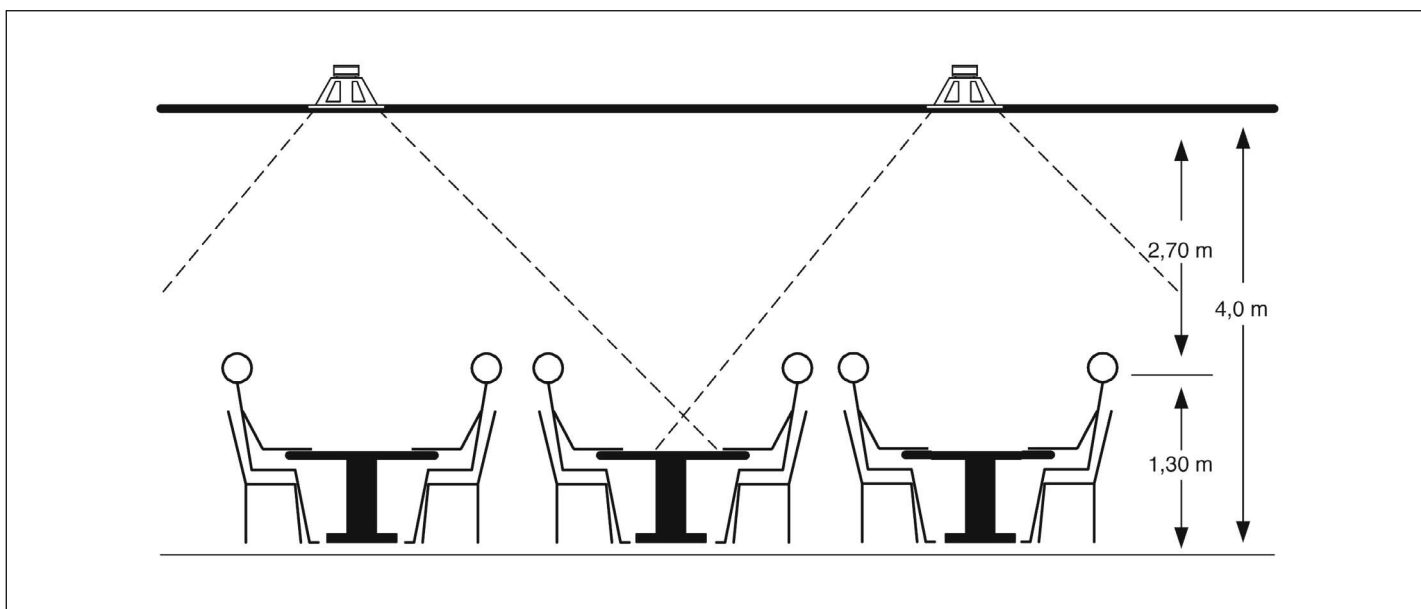

The actual distance depends on the basic volume in the room. In a quiet environment a distance which is by 50 % larger can be selected, that is approx. 8 m.

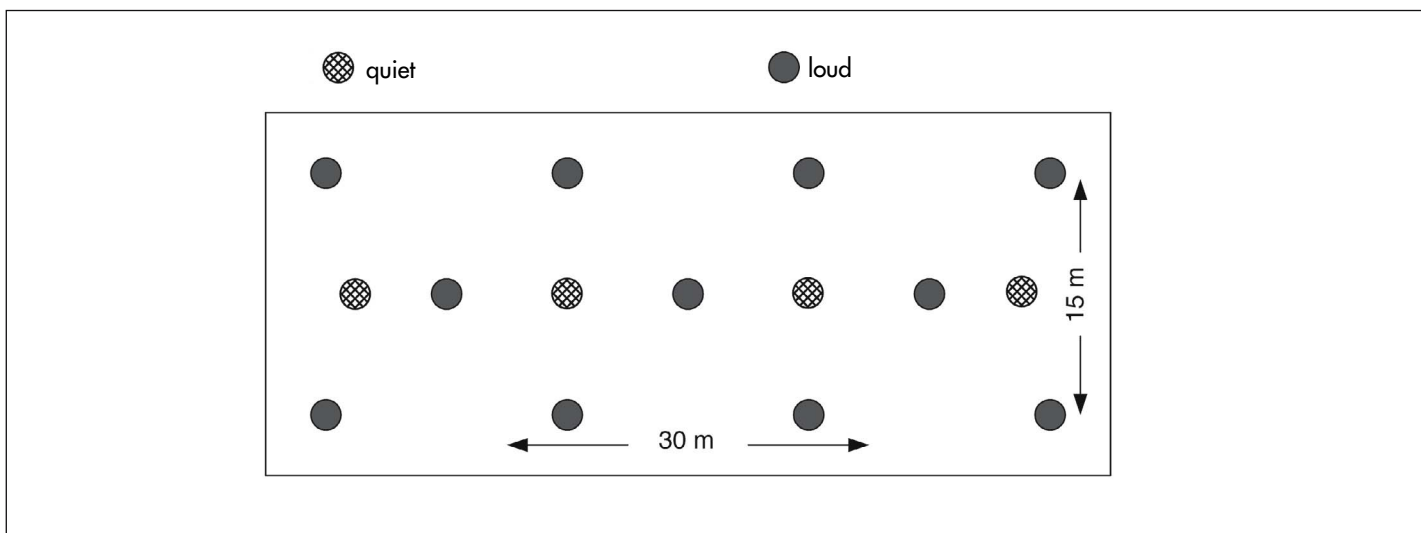

Example of a speaker arrangement for a quiet and a loud environment.

### High-Quality PA Application on Sports Fields

Even nowadays, PA applications on sports fields can be a real challenge. On the one hand, large distances have to be mastered, on the other hand, the transmission of voice and music must be possible, too. In addition, another requirement is that the speakers have to be rigidly mounted to poles or buildings in such a way that optimum weather protection is guaranteed. Most of the times, one requirement remains unconsidered. Although the classic horn speakers allow for outdoor installation, the sound quality is often only suitable for voice transmissions.

The application of new speaker systems will change that.

The horn speaker **IT-300TW** does no longer feature a basic horn speaker system. This speaker consists of a 16 cm bass speaker and a built-in horn tweeter. Thus, a clearly better sound quality is achieved. Therefore, this speaker is also called a music horn. The quality of the speaker will also improve voice transmission, because a more powerful sound allows for a better audibility.

## SPEAKERS



## AMPLIFIER

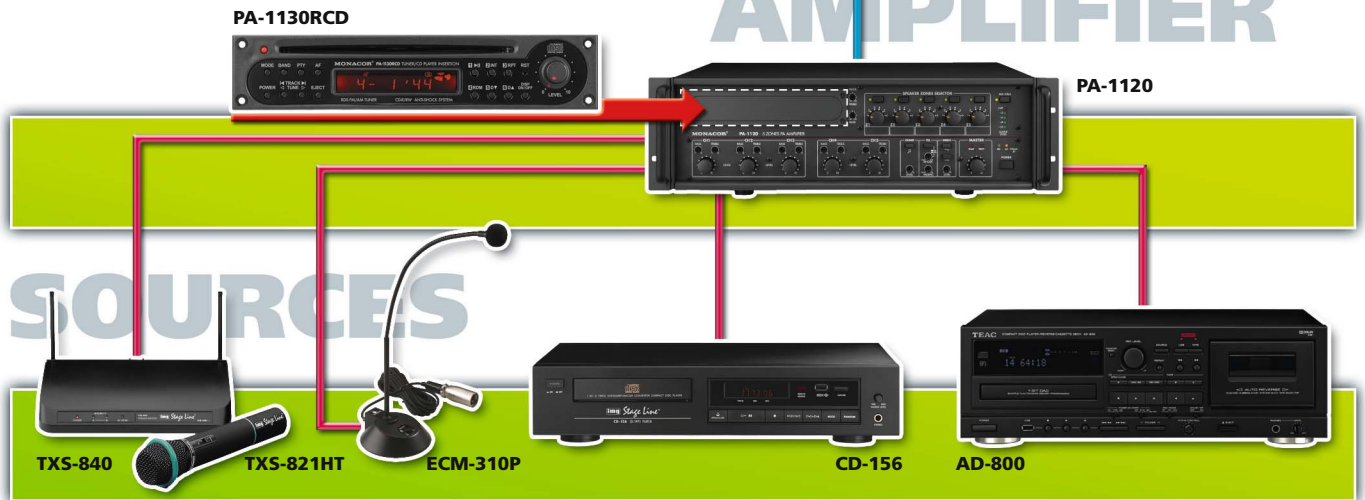

The music horns from MONACOR are the state-of-the-art solution in order to use the full range of a horn speaker with a clearly extended frequency range. The 2-way technology with a dynamic cone bass-midrange speaker and a horn tweeter allows for an increase in the sound quality and permits to radiate the keynotes of voices and instruments which cannot be achieved by conventional horn speakers. The music horns are a perfect solution whenever an optimum voice volume and/or a more complete music transmission is required.

## IT-400TW

Order No. 16.2580



### Weatherproof horn speaker (music horn), 2-way technology

- 100V line technique with very high tapping power
- Weatherproof and IP66 certified
- Very wideband sound with a distinct bass volume even at very high volume levels
- 16cm bass-midrange speaker and 25mm (1") horn
- Suitable for general indoor and outdoor applications wherever a high sound pressure level and a particularly good sound are required
- Robust plastic housing with extra low resonance and very high rear dampening
- Supplied with mounting bracket and screws made of stainless steel
- Connection via screw terminals with 4 power taps



100V ABS Weather Tweeter

## IT-300TW

Order No. 16.2230



### Weatherproof horn speaker (music horn), 2-way technology

- 100V line technique with high power taps
- Weatherproof and IP66 certified
- Especially wideband sound with a distinct bass volume
- 16cm bass-midrange speaker and 25mm (1") horn
- Suitable for general indoor and outdoor applications wherever a high sound pressure level and a particularly good sound are required
- Robust light grey ABS plastic housing
- Supplied with mounting bracket and stainless steel screws
- Connection via screw terminal strip with 4 power taps

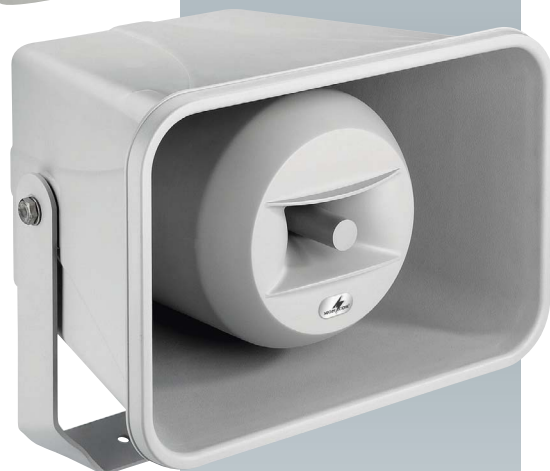

100V ABS Weather Tweeter

## IT-100TW

Order No. 16.2570



### Weatherproof horn speaker (music horn), 2-way technology.

- 100V line technique
- Weatherproof and IP66 certified
- Wideband sound with clear bass frequencies
- 13cm bass-midrange speaker and 25mm (1") horn
- Suitable for indoor and outdoor applications
- Robust plastic housing of very low resonance
- Supplied with mounting bracket and screws made of stainless steel
- Connection via screw terminals with 4 power taps



100V ABS Weather Tweeter

Model	IT-400TW	IT-300TW	IT-100TW
Power rating	60/30/15/7.5W <sub>RMS</sub>	30/15/7.5/3.75W <sub>RMS</sub>	30/15/7.5/3.75W <sub>RMS</sub>
Frequency range	100-15,000Hz	100-15,000Hz	110-16,000Hz
SPL (1W/1m)	101dB	101dB	99dB
Radiation angle (hor./vert.)	100°/60°	100°/60°	110°/60°
Admiss. ambient temp.	-20 °C to +50 °C	-20 °C to +50 °C	-20 °C to +50 °C
Dimensions	420x335x400mm	370x250x300mm	310x215x330mm
Weight	7.1kg	4.7kg	4.7kg
Special feature	IP66, ABS, 2-way	IP66, ABS, 2-way	IP66, ABS, 2-way



**IT-50**

Order No. 16.0150



**Horn speaker**

- Humidity-proof
- 100V line technique
- For industrial use, in workshops

**100V Aluminium**



**IT-40**

Order No. 16.1360



**Weatherproof horn speaker**

- 100V line technique
- Weatherproof and IP66 tested
- Protected against powerful water jets
- Suitable for general indoor and outdoor applications
- Robust plastic housing
- Mounting bracket and screws made of stainless steel
- 5-step power selector switch

**100V ABS Weather**

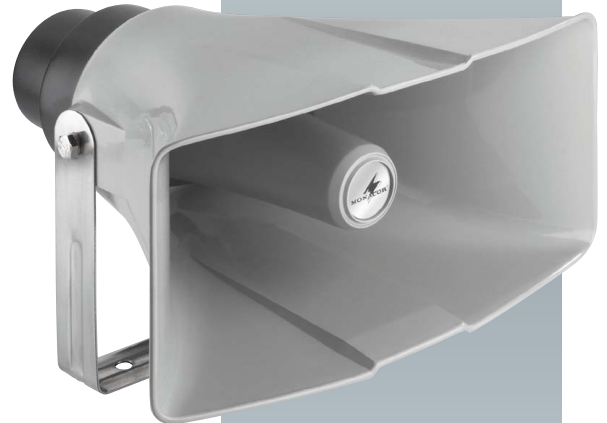

**IT-35**

Order No. 16.0870



**Weatherproof horn speaker**

- 100V line technique
- Weatherproof and IP66 tested
- Protected against powerful water jets
- Suitable for general indoor and outdoor applications
- Robust plastic housing
- Mounting bracket and screws made of stainless steel
- 5-step power selector switch

**100V ABS Weather**



Model	IT-50	IT-40	IT-35
Power rating	50/25/15/5W <sub>RMS</sub>	40/30/20/10/5W <sub>RMS</sub>	25/20/15/10/5W <sub>RMS</sub>
Frequency range	200-9,000Hz	180-7,000Hz	250-10,000Hz
SPL (1W/1m)	107.5dB	113dB	108dB
Radiation angle (hor./vert.)	90°/90°	100°/45°	110°/52°
Admiss. ambient temp.	-	-20 °C to +50 °C	-20 °C to +50 °C
Dimensions	ø 390mm x 440mm	400x200x420mm	300x180x315mm
Weight	5.5kg	3.9kg	2.5kg
Special feature	aluminium	IP66, plastic	IP66, plastic
Replacement voice coil	IT-50/VC	IT-40/VC	IT-230/VC

The corresponding radiation angles can be found on the Internet at [www.monacor.com](http://www.monacor.com)

### IT-130

Order No. 16.1710



#### Weatherproof horn speaker

- 100V line technique
- Weatherproof and IP66 tested
- Protected against powerful water jets
- Power selector switch
- For open-air events, industrial use, in workshops

100V ABS Weather

### IT-115

Order No. 16.1700



#### Weatherproof horn speaker

- 100V line technique
- Weatherproof and IP66 tested
- Protected against powerful water jets
- Power selector switch
- For open-air events, industrial use, in workshops

100V ABS Weather

### IT-110

Order No. 16.1690



#### Horn speaker

- 100V line technique
- Weatherproof and IP66 tested
- Protected against powerful water jets
- Power selector switch
- For open-air events, industrial use, in workshops

100V ABS Weather



Model	IT-130	IT-115	IT-110
Power rating	30/15/10/5/3/1W <sub>RMS</sub>	15/10/5/3/1W <sub>RMS</sub>	10/5/3/1W <sub>RMS</sub>
Frequency range	250-16,000Hz	280-12,500Hz	315-12,500Hz
SPL (1W/1m)	109dB	108dB	105dB
Radiation angle (hor./vert.)	no data	no data	no data
Admiss. ambient temp.	-20 °C to +50 °C	-20 °C to +50 °C	-20 °C to +50 °C
Dimensions	290x215x260mm	225x160x235mm	175x130x185mm
Weight	1.7kg	1.3kg	1.1kg
Special feature	IP66, ABS plastic	IP66, ABS plastic	IP66, ABS plastic

**IT-33**

Order No. 16.2190



**Weatherproof horn speaker**

- 100V line technique
- IP64 tested, splashproof
- Particularly high power capability in relation to the size of the speaker
- Robust ABS plastic housing, self-extinguishing
- Suitable for general indoor and outdoor applications
- Integrated high-pass filter for optimising the sound and stability

**100V ABS Weather**



**IT-30**

Order No. 16.0670



**Weatherproof horn speaker**

- 100V line technique
- Weatherproof and IP66 tested
- Protected against powerful water jets
- Suitable for general indoor and outdoor applications
- Aluminium housing
- Mounting bracket and screws made of stainless steel
- 4-step power selector switch

**100V Aluminium Weather**

The corresponding radiation angles can be found on the Internet at [www.monacor.com](http://www.monacor.com)



**IT-20**

Order No. 16.0660



**Weatherproof horn speaker**

- 100V line technique
- Weatherproof and IP66 tested
- Protected against powerful water jets
- Suitable for general indoor and outdoor applications
- Robust plastic housing
- Mounting bracket and screws made of stainless steel
- 4-step power selector switch

**100V ABS Weather**



Model	IT-33	IT-30	IT-20
Power rating	25/12.5/6.25W <sub>RMS</sub>	20/15/10/5W <sub>RMS</sub>	15/10/5/2.5W <sub>RMS</sub>
Frequency range	500-13,000Hz	250-10,000Hz	275-7,000Hz
SPL (1W/1m)	107dB	108.5dB	106dB
Radiation angle (hor./vert.)	90°/90°	80°/80°	100°/50°
Admiss. ambient temp.	-20 °C to +50 °C	-20 °C to +50 °C	-20 °C to +50 °C
Dimensions	ø 130mm x 175mm	ø 265mm x 310mm	250x145x300mm
Weight	1.8kg	2.3kg	2.0kg
Special feature	IP64, self-extinguishing ABS	IP66, aluminium	IP66, plastic
Replacement voice coil	-	IT-230/VC	IT-230/VC

### NR-40KS

Order No. 16.1370



#### Weatherproof horn speaker

- 16Ω speaker system
- IP66 tested, protected against powerful water jets
- Suitable for general indoor and outdoor applications
- Robust plastic housing
- Mounting bracket and screws made of stainless steel

16Ω ABS Weather

### UHC-30

Order No. 16.0640



#### Weatherproof horn speaker

- 8Ω speaker system
- IP66 tested, protected against powerful water jets
- For open-air events, industrial use, in workshops
- Mounting bracket and screws made of stainless steel

8Ω Aluminium Weather

### NR-254KS

Order No. 16.2480



#### Weatherproof horn speaker

- 4Ω speaker system
- IP66 tested, protected against powerful water jets
- Especially suitable for voice transmissions
- Robust plastic housing of compact size
- Supplied with mounting bracket and mounting screws

4Ω ABS Weather

Model	NR-40KS	UHC-30	NR-254KS
Power rating	60W <sub>MAX</sub> /16Ω	38W <sub>MAX</sub> /8Ω	25W <sub>MAX</sub> /4Ω
Frequency range	180-7,000Hz	230-10,000Hz	600-14,000Hz
SPL (1W/1m)	113dB	108.5dB	107dB
Radiation angle (hor./vert.)	110°/45°	75°/75°	90°/90°
Admiss. ambient temp.	-20 °C to +50 °C	-20 °C to +50 °C	-20 °C to +50 °C
Dimensions	400x200x385mm	ø 310mm x 285mm	106x106x88mm
Weight	3.3kg	2.0kg	1.1kg
Special feature	IP66, plastic	IP66, aluminium	IP66, plastic
Replacement voice coil	IT-40/VC	IT-230/VC	-

## Replacement Voice Coils

For horn systems.

Model	Order No.	Suitable for:
IT-50/VC	16.0370	IT-50
IT-230/VC	16.0750	IT-20, IT-30, IT-35, UHC-30, NR-33KS
IT-40/VC	16.1380	IT-40, NR-40KS
KU-516/VC	16.0730	KU-516
KU-616T/VC	16.0720	KU-616T
KU-916T/VC	16.1620	KU-916T



The corresponding radiation angles can be found on the Internet at [www.monacor.com](http://www.monacor.com)

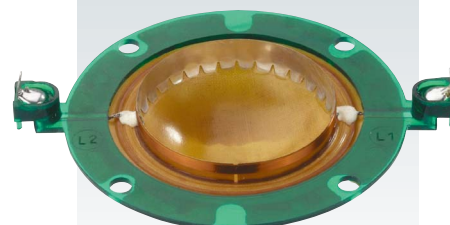



**NR-35KS**

Order No. 16.0250



**Horn speaker**

- Humidity-proof
- 8Ω speaker system

8Ω ABS



**NR-33KS**

Order No. 16.0650



**Weatherproof horn speaker**

- IP66 tested, protected against powerful water jets
- 8Ω speaker system
- Suitable for general indoor and outdoor applications
- Robust plastic housing
- Mounting bracket and screws made of stainless steel

8Ω ABS Weather



**NR-25KS**

Order No. 16.0240



**Horn speaker**

- Humidity-proof
- 8Ω speaker system

8Ω ABS



**NR-24KS**

Order No. 16.1020



**Horn speaker**

- Humidity-proof
- 8Ω speaker system

8Ω ABS



**NR-22KS**

Order No. 16.1010



**Horn speaker**

- Humidity-proof
- 8Ω speaker system

8Ω ABS



**NR-20KS**

Order No. 16.1000



**Horn speaker**

- Humidity-proof
- 8Ω speaker system

8Ω ABS

Model	NR-35KS	NR-33KS	NR-25KS	NR-24KS	NR-22KS	NR-20KS
Power rating	40W <sub>MAX</sub> /8Ω	23W <sub>MAX</sub> /8Ω	30W <sub>MAX</sub> /8Ω	30W <sub>MAX</sub> /8Ω	15W <sub>MAX</sub> /8Ω	10W <sub>MAX</sub> /8Ω
Frequency range	300-12,000Hz	275-7,000Hz	350-8,000Hz	400-7,000Hz	600-7,000Hz	800-7,000Hz
SPL (1W/1m)	107dB	106dB	102dB	105dB	104dB	103dB
Radiation angle (hor./vert.)	100°/50°	100°/50°	-	-	-	-
Admiss. ambient temp.	-	-20 °C to +50 °C	-	-	-	-
Dimensions	280x170x215mm	250x145x272mm	200x140x235mm	200x150x235mm	ø 135mm x 165mm	ø 90mm x 105mm
Weight	2.0kg	1.5kg	1.4kg	1.1kg	0.5kg	0.4kg
Special feature	plastic	IP66, plastic	plastic	plastic	plastic	plastic
Replacement voice coil	-	IT-230/VC	-	-	-	-



### NR-15KS

Order No. 16.0220



#### Horn speaker

- Aluminium version
- Humidity-proof
- 8Ω speaker system

### NR-12KS

Order No. 16.0210



#### Horn speaker

- Aluminium version
- For open-air events, industrial use, in workshops
- Humidity-proof
- 8Ω speaker system

### NR-18KS

Order No. 16.0990



#### Horn speaker

- Humidity-proof
- 8Ω speaker system

8Ω Aluminium

8Ω Aluminium

8Ω ABS



### DH-10

Order No. 16.0010



#### Horn speaker

- Humidity-proof
- 8Ω speaker system

### RUP-5

Order No. 16.0280



#### Horn speaker

- Humidity-proof
- 8Ω speaker system

### RUS-5

Order No. 16.0290



#### Horn speaker

- Humidity-proof
- 8Ω speaker system

8Ω ABS

8Ω Aluminium

8Ω ABS

Model	NR-15KS	NR-12KS	NR-18KS	DH-10	RUP-5	RUS-5
Power rating	15W <sub>MAX</sub> /8Ω	12W <sub>MAX</sub> /8Ω	10W <sub>MAX</sub> /8Ω	10W <sub>MAX</sub> /8Ω	10W <sub>MAX</sub> /8Ω	8W <sub>MAX</sub> /8Ω
Frequency range	350-12,000Hz	350-12,000Hz	1,200-7,000Hz	350-10,000Hz	400-8,000Hz	400-8,000Hz
SPL (1W/1m)	100dB	100dB	98dB	97dB	102dB	102dB
Radiation angle (hor./vert.)	-	-	-	-	90°/90°	45°/110°
Admiss. ambient temp.	-	-	-	-	-	-
Dimensions	210x150x195mm	ø 160mm x 155mm	80x100x60mm	120x130x115mm	ø 130mm x 130mm	90x105x125mm
Weight	1.2kg	1.0kg	0.4kg	0.6kg	0.5kg	0.5kg
Special feature	aluminium	aluminium	plastic	plastic		plastic



**KU-516**

Order No. 16.0700



**Weatherproof horn driver**

- Diecast version, IP66
- Protected against powerful water jets
- Matching the horns SK-22 and SK-159
- 3.5cm (1 3/8") mounting flange

**KU-616T**

Order No. 16.0710



**Weatherproof horn driver**

- 100V line technique
- Protected against powerful water jets
- Power selector switch
- Matching the horns SK-22 and SK-159
- 3.5cm (1 3/8") mounting flange
- 55cm connection cable

**KU-916T**

Order No. 16.1610



**Weatherproof horn driver**

- 100V line technique
- Protected against powerful water jets
- Power selector switch
- Matching the horns SK-22 and SK-159
- 3.5cm (1 3/8") mounting flange
- 60cm connection cable

**16Ω** Weather

**100V** Weather

**100V** Weather

Model	KU-516	KU-616T	KU-916T
Power rating	50W <sub>RMS</sub> /75W <sub>MAX</sub> (16Ω)	60W <sub>MAX</sub>	90W <sub>MAX</sub>
Frequency range	160-6,500Hz	40/30/20/10/5W <sub>RMS</sub>	60/50/40/30/20/10W <sub>RMS</sub>
SPL (1W/1m)	113dB	160-6,500Hz	160-7,000Hz
Radiation angle (hor./vert.)	-	112dB	113dB
Admiss. ambient temp.	-20 °C to +50 °C	-	-
Dimensions	ø 125mm x 100mm	-20 °C to +50 °C	-20 °C to +50 °C
Weight	2.1kg	ø 150mm x 136mm	ø 150mm x 158mm
Special feature	IP66	2.3kg	2.8kg
Replacement voice coil	KU-516/VC	IP66	IP66
		KU-616T/VC	KU-916T/VC



**SK-159**

Order No. 16.0300

**Trumpet, for horn drivers.**

- 3.5cm (1 3/8") mounting flange
- Dimensions: 375x222x300mm (WxHxD)

**SK-22**

Order No. 16.0310

**Trumpet, for horn drivers.**

- 3.5cm (1 3/8") mounting flange
- Dimensions: ø 565mm x 460mm

This original NXT\* exciter is both an innovative and amazing possibility to easily create a high-quality audio reproduction from practically nothing. Simply adhere it to a surface capable of vibrating, drive it with a standard audio amplifier - and it's ready to be used.

## EX-1

Order No. 16.2710



### Weatherproof audio exciter/resonator (NXT\*), 8Ω, 5W

For audio reproductions via surfaces capable of vibrating. This resonator is simply adhered to doors, cabinet doors, windows, bath tubs, lightweight walls, ceiling panels, pictures or many other surfaces which are capable of vibrating and the vibration of these surfaces already create a partly impressive sound in the entire surrounding area. With doors and windows (double-glazed windows, too), this is done on both sides of the surface at practically the same quality.

- Very wide bandwidth reproduction with an amazing volume level, depending on the mounting surface
- High power capability, exceeds background volume levels
- Suitable for commercial PA applications such as background music in the entire indoor area and outdoor area and for the reproduction of info messages
- Suitable for home PA applications, e.g. terraces, adjoining rooms, bathrooms, etc.
- Waterproof (IP67)
- Supplied with adhesive pads
- 3m connection cable
- Dimension: ø 70mm x 19mm
- Weight: 115g

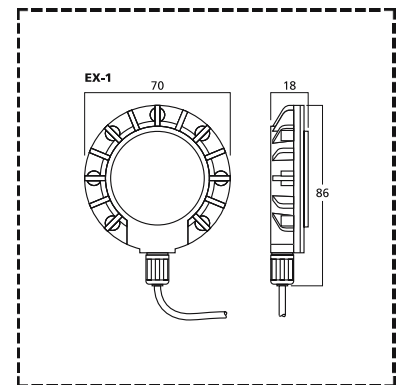

The power capability of EX-1 allows for a pleasant indoor and outdoor PA sound when directed from a window to a terrace. However, the EX-1 is not suitable for a garden party with dance music due to its electrical power rating. Attention has to be paid to an admissible load. Amplifiers of higher power capability can be connected without any problems but must not be set to the maximum rating. Both the electric power rating and the acoustic power of the EX-1 can significantly be increased when connected in parallel and serial-to-parallel in dual and 4-way arrangements.

\*) NXT and the NXT logo are trademarks of New Transducers Limited.

**Weatherproof, robust exciters/resonators for music and voice reproductions via surfaces capable of vibrating. These resonators are simply screwed onto doors, cupboard doors, shelves, desktops, lightweight walls, ceiling panels or many other surfaces which are capable of vibrating. Vibration of these surfaces already create a partly impressive sound in the entire surrounding area. These resonators are not suitable for use on glass surfaces!**

## AR-50

Order No. 16.2800



## AR-30

Order No. 16.2790



### Weatherproof audio exciters/resonators, 8Ω

- Depending on the mounting surface, very wide bandwidth reproduction with amazing volumes
- High power capability of 30W<sub>MAX</sub> (AR-30) or 50W<sub>MAX</sub> (AR-50)
- Very robust and weatherproof version, thus suitable for outdoor applications and in extra dirty conditions
- Suitable for home and outdoor PA applications, e.g. on doors, cupboards, shelves, on boats, etc.
- Waterproof (IP68)
- Supplied with screwable mounting plate



Model	AR-50	AR-30
Power rating	50W <sub>MAX</sub>	30W <sub>MAX</sub>
Impedance	8Ω	8Ω
Frequency range	depending on the installation	depending on the installation
Resonance frequency	500Hz	600Hz
Minimum mounting surface	ø 80mm	ø 80mm
Dimensions	ø 90mm x 55mm	ø 80mm x 40mm
Weight	0.95kg	0.65kg



**Attention guaranteed!**

With our range of reliable megaphones, we provide the perfect solution for each application. A few basic selection criteria will help you to choose the right unit. The operating range is surely the most important one. Here, the following applies: with increasing sound pressure (in dB), the operating range of the megaphone increases, too. Furthermore, it is possible to choose between megaphones with integrated microphone, with hand-held microphone or units with an additional wireless microphone. Each megaphone from MONACOR is supplied with power by standard batteries. As an alternative, a few units also feature a 12V connection. Size, weight and the power supply are further selection criteria for choosing the right megaphone. With these comparison criteria, you will surely find the ideal megaphone meeting your individual requirements very quickly.

**TXM-48**

Order No. 17.2380



**Wireless megaphone**, with microphone transmitter.

- Carrier frequency: 863.05-864.95MHz, operating range: approx. 30m
- Removable hand-held microphone with helix cable
- Lockable talk button and volume control at the cable-connected microphone
- Aux input with level control
- Jack for external 12V battery operation
- Siren, switchable
- Connection cable for motor vehicles
- 8mm threaded jack for mounting onto a stand

**Licence-free in the EU.**

**TM-45**

Order No. 17.1000



**Megaphone**

- Hand-held microphone with removable helix cable
- Lockable talk button and volume control at the microphone
- Aux input with level control
- Jack for external 12V battery operation
- Siren, switchable
- Connection cable for motor vehicles
- 8mm threaded jack for mounting onto a stand





## TM-35

Order No. 17.0990

122 dB 35 W<sub>MAX</sub>

### Megaphone

- Hand-held microphone with helix cable
- Lockable talk button and volume control at the microphone
- Jack for external 12V battery operation
- Siren, switchable
- Connection cable for motor vehicles
- 8mm threaded jack for mounting onto a stand



## TM-27

Order No. 17.0980

119 dB 25 W<sub>MAX</sub>

### Megaphone

- Hand-held microphone with fixed helix cable
- Lockable talk button and volume control at the microphone
- Siren, switchable
- Jack for external 12V battery operation
- Connection cable for motor vehicles



## TM-26

Order No. 17.2150

117 dB 25 W<sub>MAX</sub>

### Megaphone, with piezo converter.

- Low weight and low power consumption due to piezo technology
- Hand-held microphone with helix cable
- Lockable talk button and volume control at the microphone
- Siren and acoustic signal, switchable
- Battery status indication



## TM-17

Order No. 17.3500

110 dB 25 W<sub>MAX</sub> **NEW.**

### Megaphone

- Hand-held microphone with helix cable
- Lockable talk button and volume control at the microphone
- Operating switch for siren, speech and whistling sound
- Jack for external 12V battery operation
- Connection cable for motor vehicles

Model	TXM-48	TM-45	TM-35	TM-27	TM-26	TM-17
Built-in microphone	-	-	-	-	-	-
Hand-held microphone	X	X	X	X	X	X
Wireless microphone	X	-	-	-	-	-
Lockable button microphone	X	X	X	X	X	X
Pistol grip	-	-	-	X	X	X
Carrying strap	X	X	X	-	-	-
Wrist strap	-	-	-	-	-	-
Shoulder strap	X	X	X	X	X	X
Connection cable for motor vehicles	X	X	X	X	-	X
Siren	X	X	X	X	X	X
Acoustic signal	-	-	-	-	X	-
Volume control	X	X	X	X	X	X
Battery status indication	-	-	-	-	X	-
8mm thread	X	X	X	-	-	-
Aux input with level control	X	X	-	-	-	-
Output power	45W <sub>MAX</sub>	45W <sub>MAX</sub>	35W <sub>MAX</sub>	25W <sub>MAX</sub>	25W <sub>MAX</sub>	25W <sub>MAX</sub>
SPL (1W/1m)	124dB	124dB	122dB	119dB	117dB	110dB
Power supply	10 x 1.5V batt.	10 x 1.5V batt.	8 x 1.5V batt.	8 x 1.5V batt.	8 x 1.5V batt.	8 x 1.5V batt.
	D size	D size	C size	C size	C size	C size
	not supplied,	not supplied,	not supplied,	not supplied,	not supplied	not supplied,
	ext. 12V=4A	ext. 12V=4A	ext. 12V=3A	ext. 12V=2A		ext. 12V=2A
12V connection	X	X	X	X	-	X
Dimensions	ø 350mm x 505mm	ø 350mm x 505mm	ø 300mm x 460mm	ø 230mm x 340mm	ø 225mm x 345mm	ø 230mm x 340mm
Weight	3.4kg	3.3kg	2.5kg	1.7kg	1.2kg	1.7kg

**TM-25**

Order No. 17.0970

**Megaphone**

- Built-in microphone
- Siren, switchable
- Jack for external 12V battery operation
- Volume control
- Connection cable for motor vehicles

**TM-15**

Order No. 17.3490

**Megaphone**

- Built-in microphone
- Volume control
- Operating switch for siren, speech and whistling sound

**TM-22**

Order No. 17.2140

**Megaphone, with piezo converter.**

- Low weight and low power consumption due to piezo technology
- Built-in microphone
- Siren and acoustic signal, switchable
- Volume control
- Battery status indication

**TM-11**

Order No. 17.3480

**Megaphone**

- Built-in microphone
- Siren, switchable
- Volume control



## TM-6

Order No. 17.1800



**Megaphone**, in a plastic housing, small design.

- Built-in microphone
- Siren, switchable
- Volume control



## TM-10

Order No. 17.3470



**Megaphone**

- Built-in microphone
- Siren, switchable
- Volume control



## TM-12DC

Order No. 17.1030

**Connection cable**, 6m.

- For megaphones with external power supply
- Fitted with low-voltage plug  $\varnothing$  2.1 mm/5.5mm and cigarette lighter plug with power LED
- Integrated fine-wire fuse 5A
- Also suitable for general use



Model	TM-25	TM-15	TM-22	TM-11	TM-6	TM-10
Built-in microphone	X	X	X	X	X	X
Hand-held microphone	-	-	-	-	-	-
Wireless microphone	-	-	-	-	-	-
Lockable button microphone	-	-	-	-	-	-
Pistol grip	X	X	X	X	X	X
Carrying strap	-	-	-	-	-	-
Wrist strap	X	X	X	X	X	X
Shoulder strap	-	-	-	-	-	-
Connection cable for motor vehicles	X	-	-	-	-	-
Siren	X	X	X	X	X	X
Acoustic signal	-	X	X	-	-	-
Volume control	X	X	X	X	X	X
Battery status indication	-	-	X	-	-	-
8mm thread	-	-	-	-	-	-
Aux input with level control	-	-	-	-	-	-
Output power	25W <sub>MAX</sub>	25W <sub>MAX</sub>	20W <sub>MAX</sub>	15W <sub>MAX</sub>	8W <sub>MAX</sub>	10W <sub>MAX</sub>
SPL (1W/1m)	115dB	110dB	115dB	100dB	94dB	90dB
Power supply	8 x 1.5V batt.	8 x 1.5V batt.	8 x 1.5V batt.	8 x 1.5V battery	6 x 1.5V batt.	8 x 1.5V batt.
	C size	C size	AA size	AA size	AA size	AA size
	not supplied, ext. 12V=2A	not supplied	not supplied	not supplied	not supplied	not supplied
12V connection	X	-	-	-	-	-
Dimensions	$\varnothing$ 230mm x 370mm	$\varnothing$ 230mm x 370mm	$\varnothing$ 195mm x 315mm	$\varnothing$ 205mm x 340mm	$\varnothing$ 150mm x 237mm	$\varnothing$ 158mm x 244mm
Weight	1.7kg	1.3kg	850g	1.1kg	620g	595g

The WAP-7D system presents a new class of high-quality units for mobile voice amplification. The latest technology of rechargeable batteries, digital amplification and a perfect workmanship of high quality. The WAP-7D is even suitable as a miniature solution for background music due to the additional line input.

## WAP-7D

Order No. 17.2830



### Portable digital voice amplifier

Scope of delivery: 1 electret headband microphone, 1 mini electret microphone, 1 digital active speaker, 1 microphone extension cable, 1 line connection cable, 1 plug-in charger, 2 clips, 1 waist strap, 1 carrying strap and 1 transport bag.

- In proportion to the ultra-compact size, provides a high-quality sound for voice transmissions and a very high level stability
- For general mobile speech applications, e.g. at lectures and training sessions, aerobics, sales events
- Suitable for general applications due to versatile wearing options
- Powerful 7W digital amplifier
- Additional line input (3.5mm jack) for external audio sources, e.g. MP3 players and laptops
- Built-in lithium-ion rech. batteries (2 x 3.6V= /2,200mAh), charging of the rechargeable batteries via supplied plug-in charger
- Very long operating time of up to 30 hours with fully charged batteries

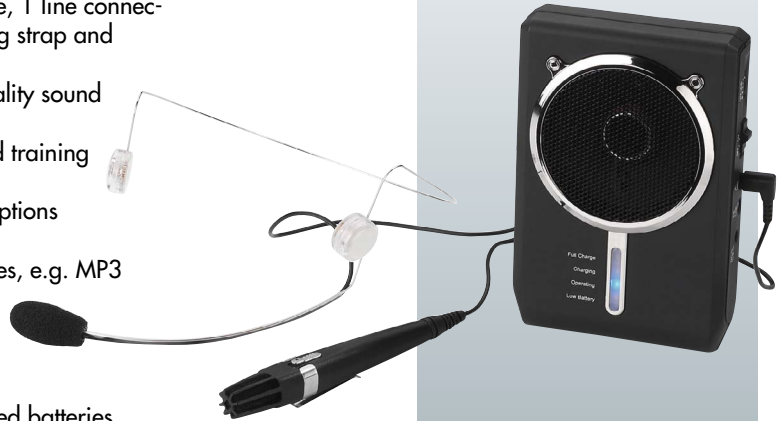

Model	WAP-7D
Frequency range	20-20,000Hz
Output power	7W <sub>MAX</sub> /5W <sub>RMS</sub>
THD	0.3%
Max. SPL	83dB
Power supply	2 x 3.6V lithium-ion rech. battery
Dimensions	85x130x26mm
Weight	280g

## WAP-5USB

Order No. 17.3460



### Waistband amplifier with integrated MP3 player

- Supplied with a high-sensitivity electret headband microphone
  - For general mobile speech applications, e.g. lectures and training sessions, aerobics, sales events
  - SD/MMC card slot for a card up to 32GB, available at option
  - Supports FAT16 and FAT32 data formats
  - MP3 format: 48-192kbps, 22/44.1kHz
  - Supports WMA
  - MP3 recording function
  - USB 2.0 interface
  - 7W amplifier with volume control
  - Headphone output (3.5mm jack)
  - Illuminated LCD
  - With adjustable waist strap
  - Battery operation/rechargeable battery operation, charging of the optional rechargeable batteries via the supplied plug-in charger, removal of the batteries not required
  - Operating time with fully charged batteries: approx. 6-8 hours
  - Power supply: 9V= (6 x AA size)
  - Supplied without batteries/rechargeable batteries
- Do not connect the plug-in charger to the voice amplifier when using standard batteries!**



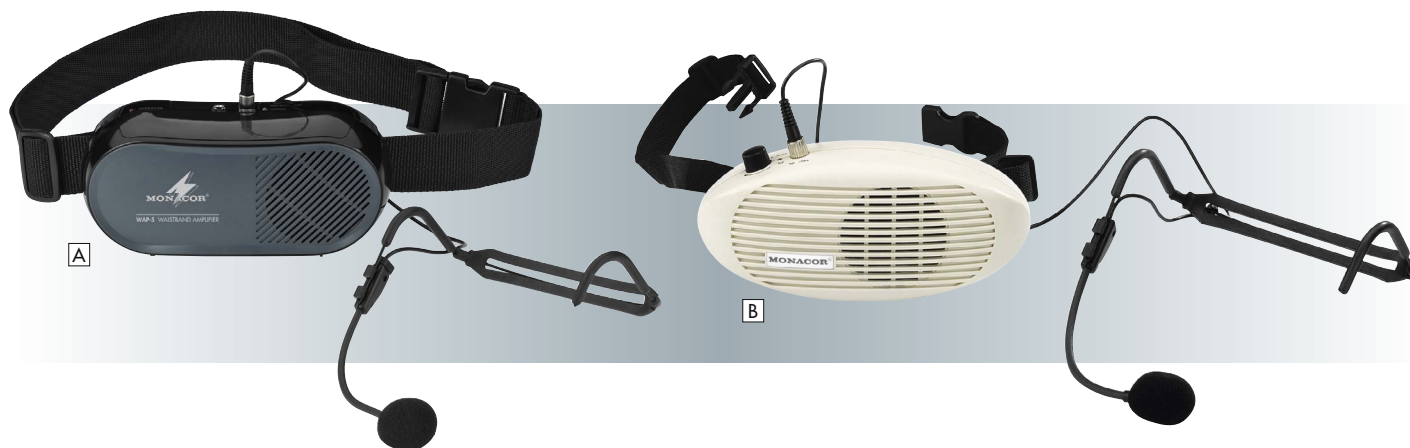

## WAP-5 A

Order No. 17.3200



### Waistband amplifier with line input

- Supplied with a high-sensitivity electret headband microphone
- For general mobile speech applications, e.g. at lectures and training sessions, aerobics, sales events
- With adjustable waist strap
- 7W amplifier with volume control
- Additional line input (3.5mm jack) for external audio sources, e.g. MP3 player
- Battery operation/rechargeable battery operation, charging of the optional rechargeable batteries via the supplied plug-in charger, removal of the batteries not required
- Operating time with fully charged batteries: approx. 6-8 hours
- Power supply: 9V $\approx$  (6 x AA size)
- Supplied without batteries/rechargeable batteries

**Do not connect the plug-in charger to the voice amplifier when using standard batteries!**

## WAP-4 B

Order No. 17.2560



### Waistband amplifier (dynamic microphone)

- Dynamic microphone cartridge, thus resistant to acoustic feedback
- For general mobile speech applications, e.g. at lectures and training sessions, aerobics, sales events
- Designed as a belt bag with adjustable snap-in strap
- 5W voice amplifier with volume control
- Battery operation/rechargeable battery operation, charging of the optional rechargeable batteries via the supplied plug-in charger, removal of the batteries not required
- Operating time with fully charged batteries: approx. 6-8 hours
- Power supply 9V $\approx$  (6 x AA size)
- Supplied without batteries/rechargeable batteries

**Do not connect the plug-in charger to the voice amplifier when using standard batteries!**

## WAP-3 B

Order No. 17.0900



### Waistband amplifier (electret microphone)

- Supplied with a high-sensitivity electret headband microphone
- For general mobile speech applications, e.g. at lectures and training sessions, aerobics, sales events
- Designed as a belt bag with adjustable snap-in strap
- 5W voice amplifier with volume control
- Battery operation/rechargeable battery operation, charging of the optional rechargeable batteries via the supplied plug-in charger, removal of the batteries not required
- Operating time with fully charged batteries: approx. 6-8 hours
- Power supply 9V $\approx$  (6 x AA size)
- Supplied without batteries/rechargeable batteries

**Do not connect the plug-in charger to the voice amplifier when using standard batteries!**

The pictures for WAP-4 and WAP-3 are identical

Do not connect the plug-in charger to the voice amplifier when using standard batteries!

## WAP-3BAG

Order No. 17.2720

### Protective transport bag, for waistband amplifier WAP-3 or WAP-4.

- Black nylon belt bag with zip fastener
- Two additional storage compartments with zip fastener for accessories
- Adjustable snap-in strap



### Attenuators and Co.

In most cases, PA speakers will be capable of adjusting the power drawn and thus the volume at the speaker. This is made via cable ends led through, clamping terminals or selector switches directly at the speaker. This is quite sufficient for many applications.

However, for the PA applications in different rooms with separate volume control in each case, 100 V attenuators are used.



These attenuators consist of a transformer in a saver circuit which stepwise attenuates the signal fed in.

This volume control is inserted into the 100 V line. The 100 V speaker is connected to the output. A connection of low-impedance 4 Ω or 8 Ω speakers is not possible. The attenuator is available in different power classes. The maximum rating may be as high as the power of the attenuator.

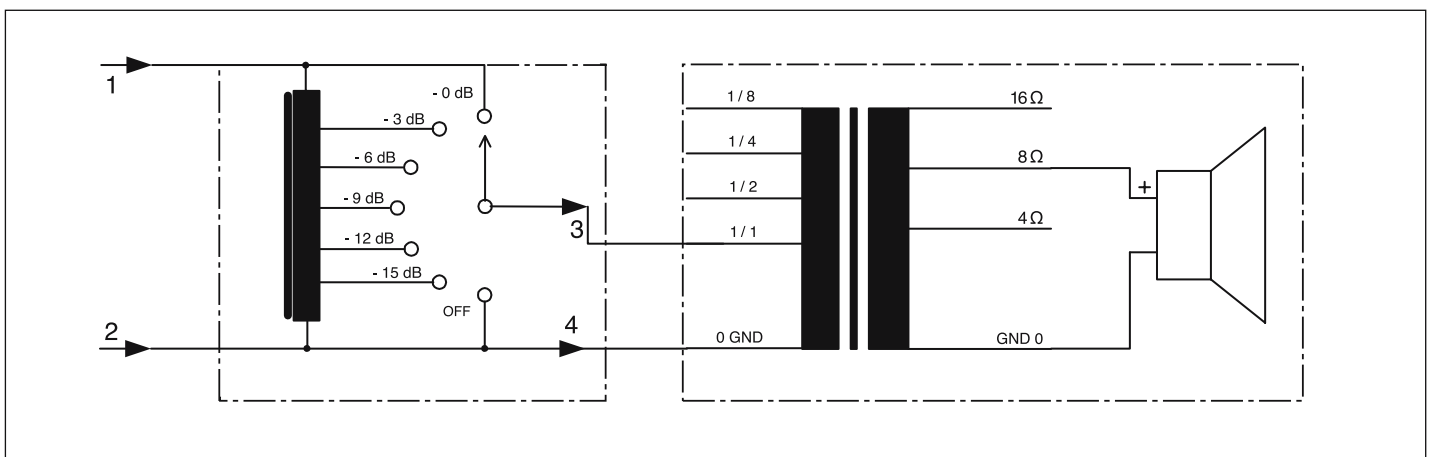

The attenuators are available in different designs. Individual attenuators are available in a surface-mount or flush-mount version as well as in front plates for 19" installation.

Larger amplifiers have integrated attenuators already, thus allowing for a direct control of the different output circuits.

## Attenuators with Emergency Priority Relay

Generally, attenuators have a switch position OFF, i.e. the speakers located behind them are switched off. An emergency announcement (in case of fire or alarm) would not be heard.

In this case, attenuators with an emergency priority relay are useful. Thus, it is possible to switch on these attenuators from the distance and to make an announcement for these areas as well.

The 100 V speaker signal arrives at the attenuator via the connections 1 + 2 and at the speaker via the connections 3 + 4 .

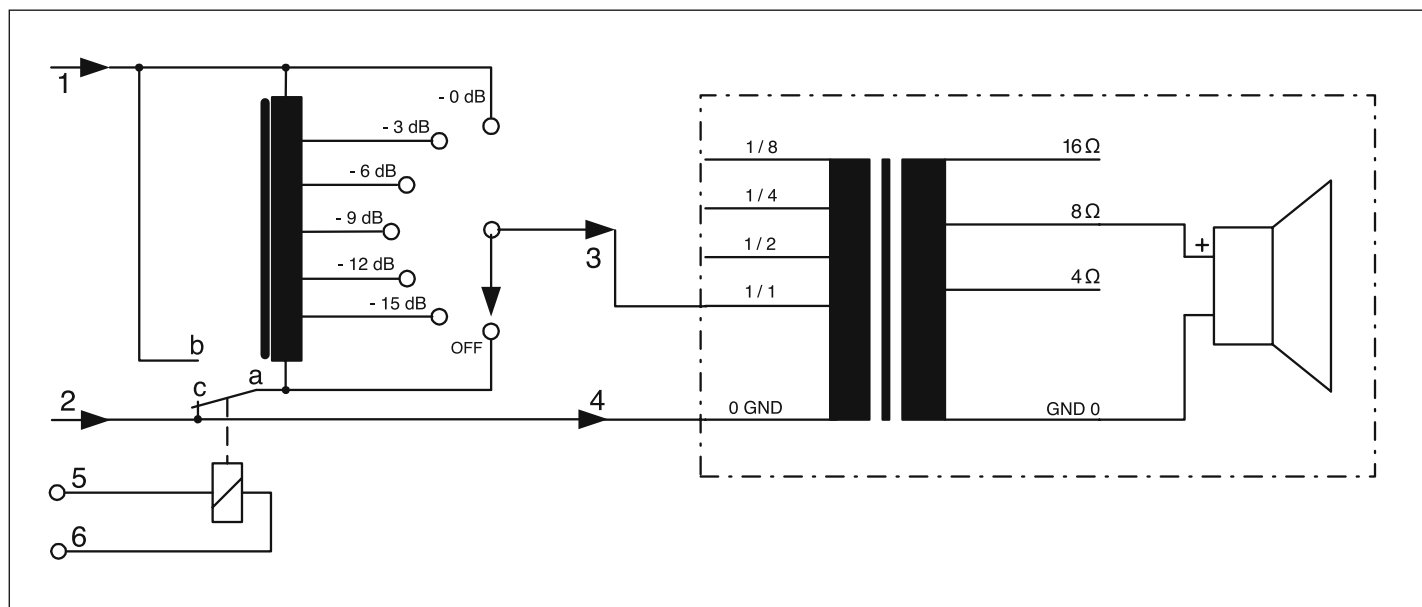

The connections 5 + 6 are new. The emergency priority relay is activated via a voltage of 24 V DC at these connections.

If the attenuator is in position OFF, the points a + c are connected.

Thus, the points 3 + 4 are also connected with each other and no signal arrives at the speaker.

Now, if the emergency priority relay is activated, the points a + b are connected. The points 2 + 4 and 1 + 3 are thus connected directly with each other and the speaker receives the full speaker signal. After deactivating the relay, the speaker is muted again.

In case, the attenuator is at an intermediate stage, the volume of the signal is increased if the relay is activated.

There are also attenuators for which the points a + b + c are available via terminals. In that case, the relay can be installed directly at the amplifier, if required.

However, the line to the relay is between the points a and c. The line resistance of this line is located below the transformer as a base resistance. Thus, minimum remainders of the speaker signal arrive at the speaker.



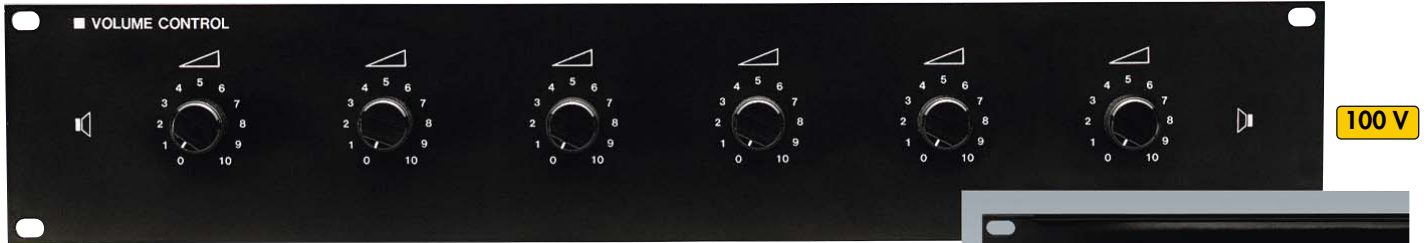

**ATT-1935**

Order No. 17.0770

**ATT-1950**

Order No. 17.1370

**ATT-19100**

Order No. 17.2640



**6-way PA volume controls for 482mm (19") rack installation**

- 6 audio transformers for 100V line technique
- Connection for priority circuit, 6 priority relays (24V~/20mA)
- Attenuation in 10 steps, position 0 is OFF
- Aluminium front panel
- Available in 3 power classes
- Screw plug-in connection

Model	ATT-1935	ATT-1950	ATT-19100
Frequency range	50-18,000Hz	50-18,000Hz	50-18,000Hz
Power rating	6x35V <sub>RMS</sub>	6 x 50V <sub>RMS</sub>	6 x 100V <sub>RMS</sub>
Priority facility	yes	yes	yes
Dimensions	484x88x77mm, 2RS	484x88x77mm, 2RS	484x88x77mm, 2RS
Weight	1.4kg	1.6kg	1.8kg

**ATT-442ST**

Order No. 17.1860

**4-channel speaker volume control, stereo**

Particularly high quality due to transformer technique with universal output assignment (4-16Ω for each speaker), 20-20,000Hz, attenuation in 10 steps for each pair, position 0 is OFF.

- 2 stereo inputs (100W<sub>RMS</sub> max. for each channel) and 4 stereo speaker outputs (18W<sub>RMS</sub>/4-16Ω each)
- Source selector switch for each speaker output
- Screw terminals
- Black metal housing
- Dimensions: 432x78x190mm
- Weight: 3.4kg



This unit finally allows to control the level of several pairs of speakers (up to 4) independently of each other even without 100V line technique and to connect them together to basic amplifiers, too, without any difficulties. Even speakers with different impedances between 4 and 16Ω can be mixed as desired. Ideally suited for applications in restaurants and bars.

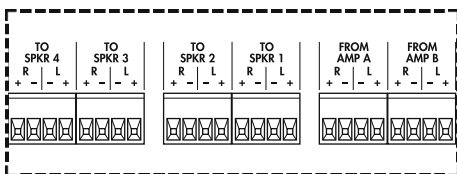

## A PA System for Individual Rooms with Programme Selectors

A greater number of rooms, e.g. in a hotel or in a solarium, is to be supplied with 5 different music programmes respectively.

For this purpose, 5 individual amplifiers are equipped with a radio module each. Alternatively, CD insertions are possible, too. In each room, a selector switch with following attenuator is used to which a

speaker is connected. Thus, it is possible to select programme and volume in each room independently of the other.

As it may theoretically be possible that all users have selected the same programme and the maximum volume, the power of the amplifier must be selected accordingly.

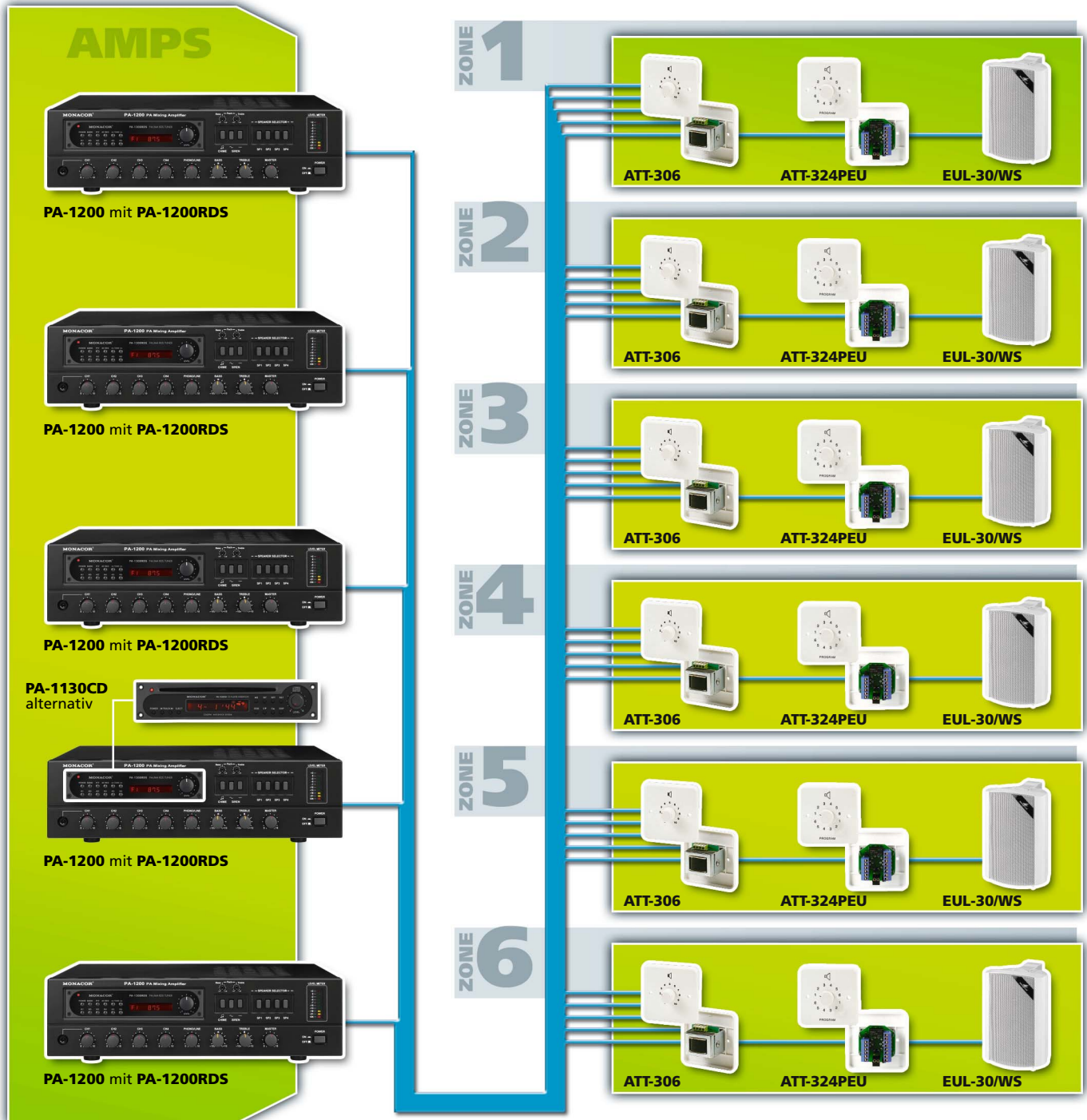

- List of materials**
- 5 x PA-1200 ..... amplifier
  - 5 x PA-1200RDS ..... tuner insertion
  - PA-1130CD alternatively .. CD insertion

- 6 x ATT-306 ..... programme selector
- 6 x ATT-324PEU ..... volume control
- 3 x EUL-30/WS ..... pair of wall-mount speakers

Instead of 6 x ATT-306 and 6 x ATT-324PEU, the combination unit ATT-424PEU can also be used.

### PA Volume Control/Programme Selector Combinations

- PA programme selectors for 6 signal sources and wall-mount PA volume controls with 24V emergency priority relay and common front panel
- Suitable for 100V audio line technique
- Built-in relay (24V) for priority circuit
- Attenuation in 10 steps, position 0 is OFF
- Flush mounting or surface mounting with matching housing ATT-400, available at option
- Mounting depth: 45mm
- Screw plug-in connection

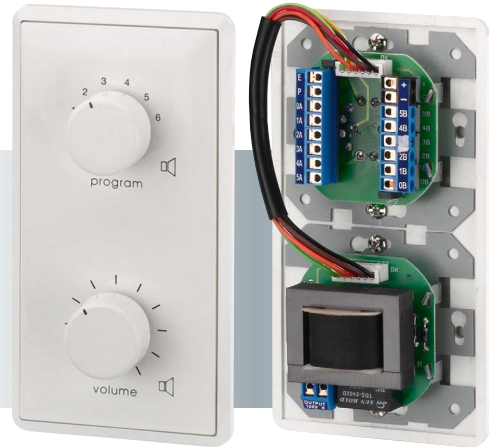

Model	Order No.	Frequency range	Power rating	Priority facility	Dimensions	Weight	Surface-mount housing
ATT-412PEU	17.1460	50-18,000Hz	12W <sub>RMS</sub>	yes	80x154x67mm	365g	ATT-400
ATT-424PEU	17.1470	50-18,000Hz	24W <sub>RMS</sub>	yes	80x154x67mm	315g	ATT-400
ATT-436PEU	17.1480	50-18,000Hz	36W <sub>RMS</sub>	yes	80x154x67mm	365g	ATT-400
ATT-450PEU	17.1490	50-18,000Hz	50W <sub>RMS</sub>	yes	80x154x67mm	365g	ATT-400

### Wall-Mount PA Volume Controls with 24V Emergency Priority Relay

- Attenuation in 10 steps, position 0 is OFF
- Audio transformer for 100V line technique
- Snow-white plastic front panel and knob
- Flush mounting in standard 60mm wall sockets
- Surface mounting with matching housing ATT-300, available at option
- Mounting depth: 45mm
- Screw plug-in connection



Model	Order No.	Frequency range	Power rating	Priority facility	Dimensions	Weight	Surface-mount housing
ATT-312PEU	17.1380	50-18,000Hz	12W <sub>RMS</sub>	yes	80x80x67mm	190g	ATT-300
ATT-324PEU	17.1390	50-18,000Hz	24W <sub>RMS</sub>	yes	80x80x67mm	190g	ATT-300
ATT-336PEU	17.1400	50-18,000Hz	36W <sub>RMS</sub>	yes	80x80x67mm	240g	ATT-300
ATT-350PEU	17.1410	50-18,000Hz	50W <sub>RMS</sub>	yes	80x80x67mm	240g	ATT-300
ATT-3100PEU	17.2630	50-18,000Hz	100W <sub>RMS</sub>	yes	80x80x67mm	295g	ATT-300



Unsere neuen Spezialkataloge:  
**SECURITY und ELA-TECHNIK**

Our new special catalogues:  
**SECURITY and PA Technology**

**MONACOR**<sup>®</sup>  
www.monacor.com



### ATT-306

Order No. 17.1420

#### PA programme selector

- Switches one of 6 signal sources to one speaker output
- For 100V audio technique or other signals
- Built-in relay (24V) for priority circuit
- Snow-white plastic front panel and knob
- Flush mounting in standard 60mm wall sockets
- Surface mounting with matching housing ATT-300, available at option
- Mounting depth: 35mm
- Screw plug-in connection

### ATT-325ST

Order No. 17.1430

#### Stereo volume control, of high-quality transmitting technology.

- 4Ω amplifier input and 4Ω speaker output
- Power rating: 25W<sub>RMS</sub> per channel
- Attenuation in 10 steps, position 0 is OFF
- Snow-white plastic front panel and knob
- Surface mounting with matching housing ATT-300, available at option
- Mounting depth: 50mm
- Screw plug-in connection

### Wall-Mount PA Volume Controls

- Attenuation in 10 steps, position 0 is OFF
- Audio transformer for 100V line technique
- White plastic front panel and knob
- Flush mounting, surface mounting with matching housing ATT-200 which is available at option



Model	Order No.	Frequency range	Power rating	Priority facility	Dimensions	Weight	Surface-mount housing
ATT-210/WS	17.0560	50-18,000Hz	10W <sub>RMS</sub>	can be retrofitted, via separate relay	80x80x40mm	220g	ATT-200
ATT-225/WS	17.0570	50-18,000Hz	25W <sub>RMS</sub>	can be retrofitted, via separate relay	80x80x40mm	220g	ATT-200
ATT-235/WS	17.0580	50-18,000Hz	35W <sub>RMS</sub>	no	80x80x40mm	250g	ATT-200
ATT-250/WS	17.0590	50-18,000Hz	50W <sub>RMS</sub>	no	80x80x40mm	250g	ATT-200
ATT-2100/WS	17.2610	50-18,000Hz	100W <sub>RMS</sub>	no	80x80x40mm	260g	ATT-200

### Wall-Mount PA Volume Controls with 24V Emergency Priority Relay

- Attenuation in 10 steps, position 0 is OFF
- Audio transformer for 100V line technique
- White plastic front panel and knob
- Flush mounting, surface mounting with matching housing ATT-200 which is available at option



Model	Order No.	Frequency range	Power rating	Priority facility	Dimensions	Weight	Surface-mount housing
ATT-210PIWS	17.0920	50-18,000Hz	10W <sub>RMS</sub>	yes	80x80x40mm	250g	ATT-200
ATT-225PIWS	17.0930	50-18,000Hz	25W <sub>RMS</sub>	yes	80x80x40mm	250g	ATT-200
ATT-235PIWS	17.0940	50-18,000Hz	35W <sub>RMS</sub>	yes	80x80x40mm	280g	ATT-200
ATT-250PIWS	17.0950	50-18,000Hz	50W <sub>RMS</sub>	yes	80x80x40mm	280g	ATT-200
ATT-2100PIWS	17.2620	50-18,000Hz	100W <sub>RMS</sub>	yes	80x80x40mm	270g	ATT-200



**ATT-200**

Order No. 17.0550

Surface-mount housing, for wall-mount PA volume controls but also as protective housing for flush mounting. White plastic, suitable for the 200 series with 2-hole fixing.

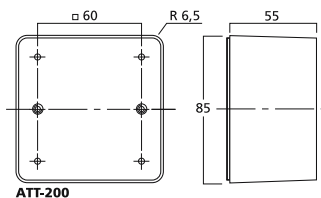

**ATT-300**

Order No. 17.1440

Surface-mount housing, for wall-mount PA volume controls of the series ATT-3...PEU. Snow-white plastic.

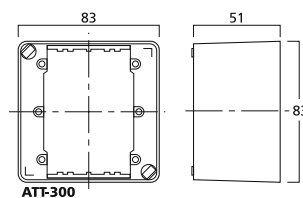

**ATT-400**

Order No. 17.1450

Surface-mount housing, for wall-mount PA volume controls of the series ATT-4...PEU. Snow-white plastic.

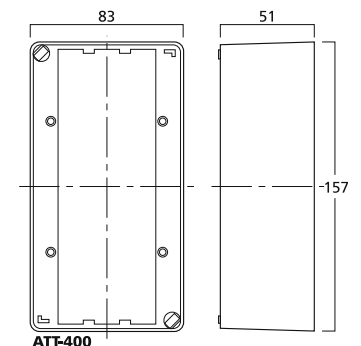

**ATT-200P**

Order No. 17.0870

Front panel, white, plastic

- For universal mounting in combination with surface-mount housing ATT-200
- Without imprint
- With drill hole  $\varnothing$  9.0mm

**ATT-500U**

Order No. 17.2130

Mounting frame

- For all chassis jacks of the D series from NEUTRIK
- Flush mounting in standard 60mm wall sockets
- Surface mounting with matching housing ATT-300, available at option
- Supplied with mounting screws

**ATT-20**

Order No. 03.4500

Rotary knob, white

- For shafts  $\varnothing$  6mm, 18 teeth
- Suitable for PA volume controls ATT-.../WS
- Diameter: approx. 20mm
- Height: approx. 17mm

Supplied without chassis jacks, please order matching chassis jacks together with this item!

## Recommended Chassis Jacks for the Mounting Frame ATT-500U



Jack	Model	Order No.	
BNC	<i>NBB-75DFI</i> <i>NBB-75DFIB</i>	34.6450 34.6460	
RCA	<i>NF-2DB0</i> <i>NF-2DB2</i> <i>NF-2DB4</i>	34.7110 34.7120 34.8530	
HDMI	<i>NAHDMIW</i> <i>NAHMIWB</i>	34.8630 34.8640	
Stereo 6.3 mm	<i>NJ-3FP6C</i> <i>NJ-3FP6CBAG</i>	34.4730 34.4560	
RJ-45, Cat. 5	<i>NE-8FDVYK</i>	34.6690	
RJ-45, Cat. 5 adapter	<i>NE-8FDP</i>	34.6890	
RJ-45, Cat. 6	<i>NE-8FDYC6</i> <i>NE-8FDYC6B</i>	34.4070 34.4080	
Speakon, 2 poles Speakon, 4 poles	<i>NL-2MP</i> <i>NL-4MP</i>	34.5980 34.4230	
USB	<i>NAUSBW</i> <i>NAUSBWB</i>	34.8650 34.8660	
XLR jack, 3 poles	<i>NC-3FDL1</i> <i>NC-3FDL1BAG</i>	34.4690 34.4540	
XLR plug, 3 poles	<i>NC-3MDL1</i> <i>NC-3MDL1BAG</i>	34.4700 34.4550	
XLR jack, 5 poles	<i>NC-5FDL1</i>	34.6060	
XLR plug, 5 poles	<i>NC-5MDL1</i>	34.6070	

### 100V High-Performance Audio Transformers

An external 100V transformer is necessary for an amplifier or speaker without installed 100V audio transformer. Each of the offered 100V audio transformers can be used.

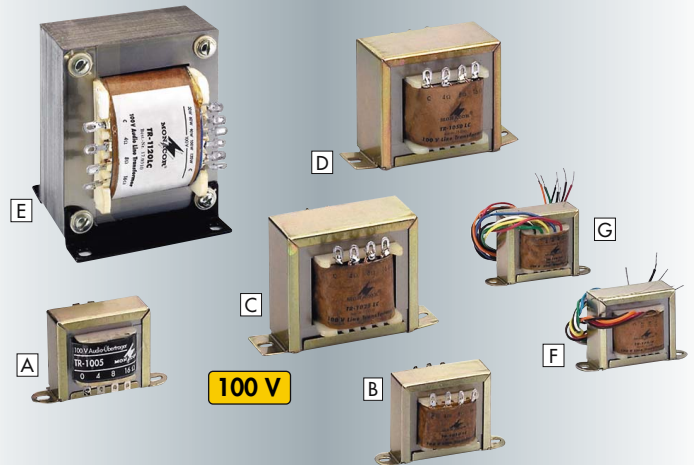
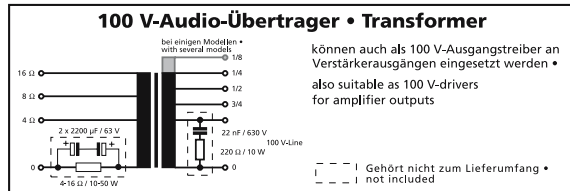

Model	Order No.	Power	Primary	Secondary	Frequency range	Dimensions	Position
TR-100S	17.0230	10W <sub>RMS</sub>	10/5/2.5/1.25/0.625W	4/8/16Ω	40-30,000Hz, -3dB	71x43x41mm	A
TR-1010LC	17.0250	10W <sub>RMS</sub>	10/7.5/5/2.5W	4/8/16Ω	35-20,000Hz, -3dB	71x43x38mm	B
TR-1025LC	17.0270	25W <sub>RMS</sub>	25/20/12/6W	4/8/16Ω	25-20,000Hz, -3dB	92x60x52mm	C
TR-1050LC	17.0290	50W <sub>RMS</sub>	50/37.5/25/12.5W	4/8/16Ω	30-15,000Hz, -3dB	92x60x58mm	D
TR-1120LC	17.0310	120W <sub>RMS</sub>	120/100/90/60/30W	4/8/16Ω	20-20,000Hz, -3dB	72x99x78mm	E
TR-175/6	17.0440	6W <sub>RMS</sub>	6/4/2/1W	4/8/16Ω	28-25,000Hz, -3dB	71x42x40mm	F
TR-175/10	17.0450	10W <sub>RMS</sub>	10/6/4/2/1W	4/8/16Ω	35-25,000Hz, -3dB	71x42x40mm	G



#### TR-520

Order No. 17.1920

100V toroidal audio transformer

- Very high-quality version with a perfect frequency response and extra low THD
- Flat version
- Sealed
- Frequency range: 20-30,000Hz
- Primary: 5/10/15/20W, secondary: 4Ω
- Dimensions: ø 60mm x 30mm
- Weight: 400g

#### TR-510

Order No. 17.1910

100V toroidal audio transformer

- Very high-quality version with a perfect frequency response and extra low THD
- Flat version
- Sealed
- Frequency range: 20-30,000Hz
- Primary: 2.5/5/7.5/10W, secondary: 4Ω
- Dimensions: ø 60mm x 30mm
- Weight: 300g

#### TR-525

Order No. 17.1210

100V toroidal audio transformer

- Very high-quality version with a perfect frequency response and extra low THD
- Extra flat version
- Sealed
- Frequency range: 20-30,000Hz
- Primary: 2.5/5W, secondary: 4Ω
- Dimensions: ø 50mm x 20mm
- Weight: 160g

#### PATL-100

Order No. 17.1180

100 V



100V transformer, for the

- connection of a 100V audio signal source to units with line input.
- Adjustable line output level (0-1.5V at 100V input voltage), can be switched internally for other output voltages
  - 100V input with screw plug-in terminal
  - Balanced XLR output, impedance: 1kΩ, XLR chassis plug
  - Insulated plastic housing
  - Galvanically isolated input and output
  - Dimensions: 171x81x61mm
  - Weight: 520g

#### LKB-1

Order No. 16.1830

Connection terminal, for 100V PA speakers.

- 3-pole ceramic screw terminal
- Thermal fuse 1A/150 °C for disconnecting a faulty speaker in case of a short circuit (fire), so that the function of one speaker line is maintained
- Dimensions: 35x20x20mm

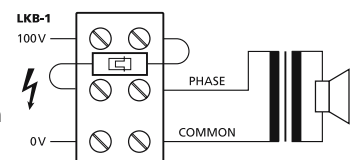

## HiFi Amplifier at 100 V Speakers

The following situation frequently occurs:

A PA system is to be established in a restaurant or bistro. The speakers to be used are easily agreed upon, 100 V compact speaker systems are to be used to keep the cabling efforts within limits.

However, the customer does not wish to buy a new amplifier but continue to use the existing HiFi amplifier. This is possible, although it is not the optimum solution.

This amplifier does not have an output for 100 V speakers. It would be possible to connect the speakers directly, but the amplifier would hardly deliver any power.

### Example of calculation:

We assume that the amplifier has an output power of 100 W at 4 Ω.

Then the output voltage would be: 
$$U = \sqrt{P \times R} \quad 20 \text{ V} = \sqrt{100 \text{ W} \times 4 \Omega}$$

We also assume that the connected speakers have a total power of 100 W. Then the total impedance of the speakers would be 100 Ω.

We continue our calculation 
$$P = \frac{U^2}{R} = \frac{20 \text{ V} \times 20 \text{ V}}{100 \Omega} = 4 \text{ W}$$

Therefore, there must be another solution.

As a 100 V transformer operates in both directions without problems, a 100 V transformer with a power of 100 W is connected to the output of the amplifier in such a way that its 4 Ω connection is connected to the amplifier output.

The 100 V signal can be picked up at the secondary side. Now the entire power of 100 W is available to the speakers. To obtain an optimum adaptation, the transformer power must correspond to the amplifier power.

If the transformer selected is too big, it does not reach the maximum voltage of 100 V at the output. If it is too small, more voltage will result; the amplifier and the speaker systems may be damaged.

The total power of the connected speakers must not exceed the amplifier power and the transformer power.

### Primary Side

The protective components at the primary side protect the amplifier at low frequencies. If frequencies below 20 Hz are passed on to the transformer, its impedance decreases more and more. Finally, only the mere wire resistor of the winding is effective but it is so low that a short circuit will occur at the output of the amplifier.

Therefore, a power resistor is inserted in series which should have the same value as the load impedance of the transformer.

With rising frequency this resistor is bridged by the capacitors. Now the full power can reach the transformer.

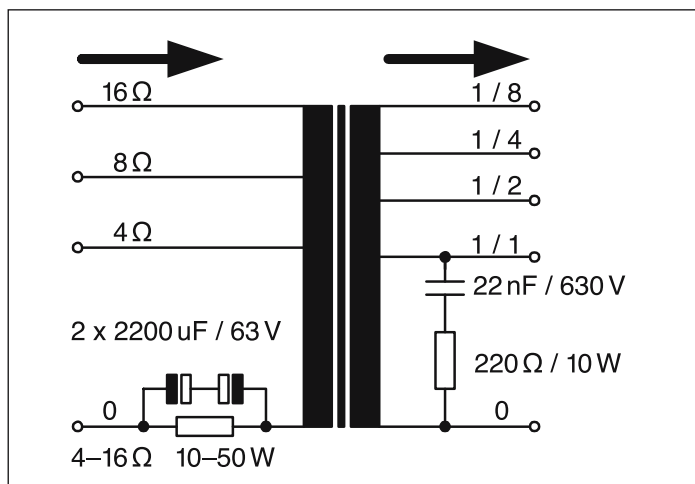

The drawing shows protective components, one RC combination each on the primary side and on the secondary side. These RC combinations are not necessary for the function of the transformer. They are merely protective components for the amplifier.

### Secondary Side

The connected speakers have different impedances at different frequencies. The RC component on the secondary side equalises these inductive load changes. The load changes may lead to vibrations of the power amplifier.

As already mentioned, these protective components are not compulsory.

To prevent complaints due to destroyed power amplifiers, these components should be included. The components themselves are standard components which should be available from every electronic retailer.



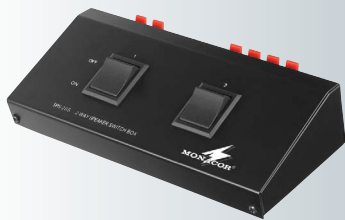

**SPS-20S**

Order No. 21.0670

**Speaker switch box**, for connecting up to 2 pairs of speakers (4-8Ω) in any combination to 1 stereo amplifier output. Music power: 200W<sub>MAX</sub>, dimensions: 176x50x100mm.



**SPS-40S**

Order No. 21.0390

**Speaker switch box**, for connecting up to 4 pairs of speakers (4-8Ω) in any combination to 1 stereo amplifier output. With integrated power protective resistors. Music power: 200W<sub>MAX</sub>, dimensions: 176x50x100mm.

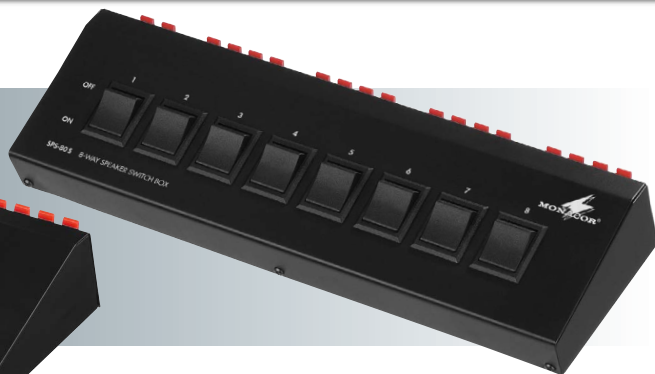

**SPS-80S**

Order No. 21.1750

**Speaker switch box**, for connecting up to 8 pairs of speakers (4-8Ω) in any combination to 1 stereo amplifier output. With integrated power protective resistors. Music power: 300W<sub>MAX</sub>, dimensions: 310x60x115mm.



**SPS-40A**

Order No. 21.0590

**Stereo line switch box**, for 4 line sources to 1 amplifier line input.



**MA-100/15**

Order No. 23.1850

**Microphone matching transformer**, with Hi/Lo switch. With balanced XLR connection as well as 6.3mm plug, unbalanced, with 15cm microphone cable.



**SMC-1**

Order No. 21.1930

**Stereo/mono converter**

- 1 x stereo to 2 x mono
- Input impedance: 4.7kΩ
- Connections: input 1 x RCA L/R, output 2 x RCA mono
- Dimensions: 65x22x37mm



**DH-95N**

Order No. 23.0030

**DH-95NP**

Order No. 23.4100

**Dynamic hand-held microphones**, low impedance, with a push-to-talk button, especially suitable for CB and PA. Supplied with microphone holder. 300-6,000Hz, 2.5mV/Pa/1kHz, 500Ω  
**DH-95N**: helix connection cable with bare cable ends  
**DH-95NP**: helix connection cable with 6.3mm stereo plug

Model	SPS-40A
Inputs	3 x L/R RCA
Outputs	1 x L/R RCA
Dimensions	125x48x100mm
Weight	350g

Model	MA-100/15
Frequency range	50-15,000Hz
Input impedance	600Ω
Transformation ratio	1:10/1:1 (1kHz)



**SLA-48**

Order No. 21.0480

**4-channel level and impedance matching amplifier**, for general audio applications. Four amplifiers by which four audio signals can be attenuated down to 1/10 (-20dB) or boosted up to 10-fold (+20dB), independent of each other.

- Level matching for audio recording and reproduction
- For preventing hum interference
- Distributing one signal to several units

Model	SLA-48
Frequency range	10-50,000Hz, ±0.5dB
Input voltage	6V max.
Output voltage	9V max.
Input impedance	100kΩ
Output impedance	1kΩ
Amplification factor	0.1-10 (±20dB) continuously adjustable
THD	< 0.03%
Crosstalk attenuation	> 58dB
S/N ratio	> 86dB
Power supply	230V~/50Hz/2.5VA
Dimensions (WxHxD)	167x37x65mm



**MH-95**

Order No. 23.0920

**Push-to-talk microphone holder**, screw-mounted.

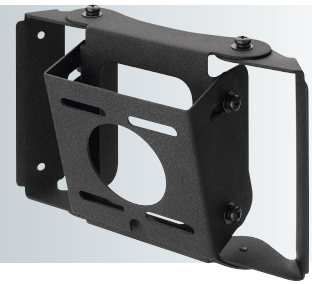

### LST-10

Order No. 12.9830

**Universal support**, black lacquered, for wall mounting or ceiling suspension of speaker systems, cameras, lights, etc., adjustable angle  $\pm 60^\circ$  in 7 steps, to be secured with supplied screws. Supplied with 4 fixing screws. Max. load: 10kg.

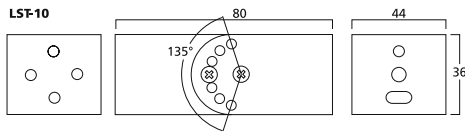

### LST-40

Order No. 11.0860



**Pair of universal supports**, robust plastic version, for wall mounting or ceiling suspension of speaker systems, movable and tiltable, tooth locking mechanism, to be secured with hexagon socket screws.

### LST-12

Order No. 12.4320

**Wall support for speaker systems**, black lacquered, also suitable for flexible corner mounting due to adjustable fixing brackets, movable mounting plate (approx.  $17^\circ$ ), to be secured with supplied screws. Supplied with 4 fixing screws. Max. load: 15kg.

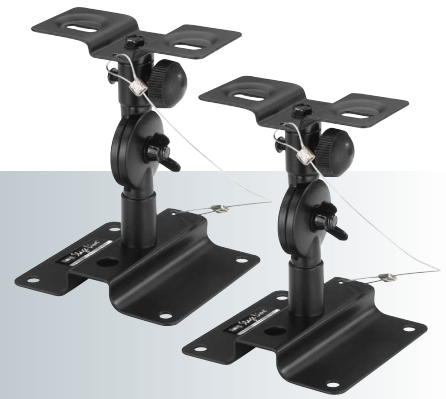
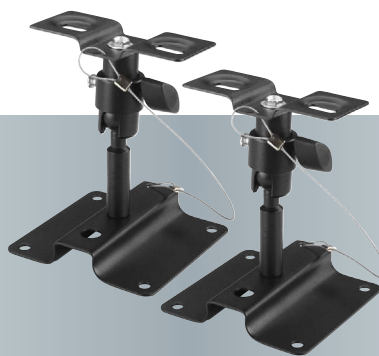
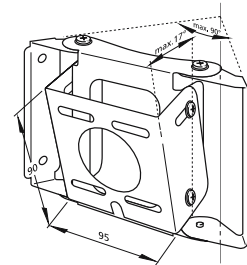

### LST-4

Order No. 12.6380



**Pair of universal supports**, solid version, black lacquered, for wall mounting or ceiling suspension of speaker systems, monitors, floodlights, etc. Can be moved in any direction and be secured with hexagon socket screws.

### LST-2

Order No. 12.6350



**Pair of universal supports**, for wall mounting or ceiling suspension of lightweight speaker systems, cameras, lights, etc.

- Black lacquered
- With ball joint for moving and tilting
- Hole distance for accepting units: 55-80mm
- Max. distance to wall: 14cm

### LST-6

Order No. 12.1680



**Pair of universal supports**, black lacquered, for wall mounting or ceiling suspension of lightweight speaker systems, cameras, lights, etc. Tilting to be adjusted via tooth locking mechanism, mounting plate can be turned and be secured by a setscrew. With safety rope.

Model	LST-40	LST-4	LST-2	LST-6
Max. load capacity at centr. weight concentration	8kg	11kg	5kg	8kg
Dimensions				
Mounting flange	82x58mm	ø 110mm	105x100mm	105x100mm
Mounting plate	82x58mm	175x110mm	108x45mm	108x48mm
Tube length	-	100mm	90mm	113mm
Weight	280g (pair)	2.3kg (pair)	1kg (pair)	1kg (pair)

**XLR Cables**

Cables for connecting units and microphone extension cables.

- 1 x XLR inline jack and 1 x XLR plug, balanced
- Shielded low-noise OFC cable material in different lengths and colours, ø 6.5mm

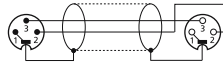

Model	Order No.	Length	Colour
MEC-50/BL	06.1680	0.7m	blue
MEC-50/GE	06.1690	0.7m	yellow
MEC-50/GN	06.1700	0.7m	green
MEC-50/RT	06.1710	0.7m	red
MEC-50/SW	06.1720	0.7m	black
MEC-100/BL	06.1740	1m	blue
MEC-100/GE	06.1750	1m	yellow
MEC-100/GN	06.1760	1m	green
MEC-100/RT	06.1770	1m	red
MEC-100/SW	06.1780	1m	black
MEC-190/BL	06.2520	2m	blue
MEC-190/GE	06.2530	2m	yellow
MEC-190/GN	06.2540	2m	green
MEC-190/RT	06.2550	2m	red
MEC-190/SW	06.2560	2m	black
MEC-20/BL	06.0670	6m	blue
MEC-20/GE	06.0680	6m	yellow
MEC-20/GN	06.0690	6m	green
MEC-20/RT	06.0700	6m	red
MEC-20/SW	06.0710	6m	black
MEC-1000/BL	06.2940	10m	blue
MEC-1000/GE	06.2950	10m	yellow
MEC-1000/GN	06.2960	10m	green
MEC-1000/RT	06.2970	10m	red
MEC-1000/SW	06.2510	10m	black
MEC-1500/SW	06.2270	15m	black
MEC-2000/SW	06.4320	20m	black

**Cables**

For line signals.

- Shielded
- Fitted with 2 x 6.3mm mono plug
- Available in different lengths and colours, ø 6.5mm

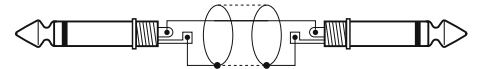

Model	Order No.	Length	Colour
MCC-50/BL	06.0490	0.5m	blue
MCC-50/RT	06.0520	0.5m	red
MCC-50/SW	06.0530	0.5m	black
MCC-100/BL	06.0370	1m	blue
MCC-100/RT	06.0400	1m	red
MCC-100/SW	06.0410	1m	black
MCC-300/BL	06.0430	3m	blue
MCC-300/RT	06.0460	3m	red
MCC-300/SW	06.0470	3m	black
MCC-600/BL	06.0550	6m	blue
MCC-600/RT	06.0580	6m	red
MCC-600/SW	06.0590	6m	black
MCC-900/SW	06.0650	9m	black



**Stereo Audio Connection Cables**

- With 2 x RCA plug on both ends
- Gold-plated contacts



**Stereo Audio Connection Cables**

- With 2 x RCA plug on both ends
- Nickel-plated contacts



**Stereo Audio Connection Cables**

- With RCA plugs.
- With straight and right-angle plugs
  - Shielded cables in different lengths
  - Gold-plated contacts
  - Cable diameter: ø 3mm

Model	Order No.	Length	Colour
AC-050G	06.6450	0.5m	black
AC-122G	06.1890	1.2m	black
AC-300G	06.2120	3m	black
AC-600G	06.2130	6m	black

Model	Order No.	Length	Colour
AC-050	06.0010	0.5m	black
AC-122	06.0020	1.8m	black
AC-300	06.2100	3m	black
AC-600	06.2110	6m	black
AC-1000	06.6730	10m	black

Model	Order No.	Length	Colour
AC-082/BL	06.4870	0.8m	blue
AC-152/BL	06.4890	1.5m	blue
AC-302/BL	06.4910	3.0m	blue
AC-502/BL	06.4930	5.0m	blue

## Microphone Cables

"TOP QUALITY"

- 50m coil or 100m reel
- 2 x 0.22mm<sup>2</sup>
- Metre marking
- Shielded
- Outside diameter: ø 6.5mm
- Capacitance: 110pF/m
- Low-noise

Model	Order No.	Length	Colour
MLC-52/BL	06.0840	50m coil	blue
MLC-52/RT	06.0870	50m coil	red
MLC-52/SW	06.0880	50m coil	black
MLC-152/BL	06.5750	100m reel	blue
MLC-152/RT	06.5770	100m reel	red
MLC-152/SW	06.5780	100m reel	black

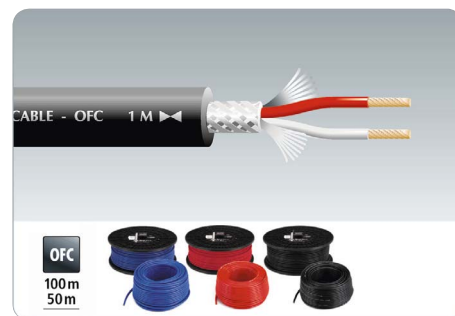

## Speaker Cables

"TOP QUALITY, HIGH FLEXIBLE"

- 100m reel
- Suitable for stage applications as well as for 100V line technique

Model	Order No.	Cores	Outside dimensions	Colour
SPC-515/BL	12.9680	2 x 1.5mm <sup>2</sup>	ø 7.4mm	blue
SPC-515/SW	12.9690	2 x 1.5mm <sup>2</sup>	ø 7.4mm	black
SPC-515/WS	12.9700	2 x 1.5mm <sup>2</sup>	ø 7.4mm	white
SPC-525/SW	12.9710	2 x 2.5mm <sup>2</sup>	ø 8.2mm	black

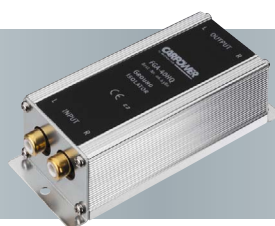
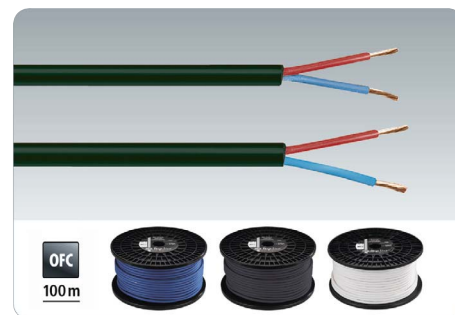

### FGA-202

Order No. 25.1660

- Professional 2-channel line transformer**, for reducing signal interference and hum loops.
- 2 inputs via balanced comb. XLR/6.3mm jacks (600Ω)
  - 2 galvanically isolated XLR outputs (600Ω) with ground lift switch
  - Frequency range: 20-20,000Hz
  - Robust metal housing with very good shielding qualities, suitable for stage applications
  - Dimensions: 125x55x75mm
  - Weight: 650g

### FGA-40HQ

Order No. 06.6380

- High-end ground isolator**
- Signal is transmitted 1:1 with separated ground, interference and hum loops are prevented
  - Gold-plated RCA plugs and RCA jacks
  - Input/output impedance: 12kΩ
  - 20-30,000Hz, THD: < 0.001%
  - 42x29x96mm, 110g

### FGA-30

Order No. 21.2430

- Stereo line transformer**, small design, for preventing signal interference and hum loops which may occur when connecting e.g. MP3 players or similar to PC sound cards or laptops.
- Galvanically isolated inputs and outputs
  - RCA jacks and 3.5mm stereo plug
  - Input/output impedance: 20kΩ
  - Frequency range: 20-30,000Hz
  - THD: < 0.01%
  - Transmission ratio 1:1
  - ø 24mm x 38mm, 32g

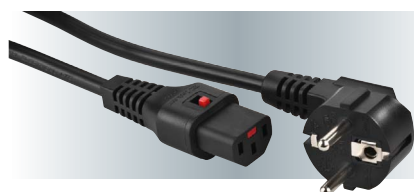

### AAC-100IEC

Order No. 05.9711

### AAC-200IEC

Order No. 05.0097

**Mains cables**

- 3-pin IEC inline jack with IEC LOCK latching device
- Cable specification: H05VV-F3G x 1mm<sup>2</sup>
- AAC-100IEC: length: 1m**
- AAC-200IEC: length: 2m**

**NEW.**

### ILA-1020

Order No. 21.2840

PAIR PAIR

- Passive level attenuators**, for attenuating excessive line levels in order to fully utilise the complete adjustment range via the volume control of the amplifier.
- Attenuation to be adjusted in 3 steps: 10dB/15dB/20dB
  - RCA plug to RCA inline jack
  - Gold-plated contacts
  - No power supply required

**RACK-42**

Order No. 24.4510

**RACK-33**

Order No. 24.4500

**RACK-21**

Order No. 24.4490



**Racks for 482mm (19") units**

- Sheet steel version
- Light grey powder coating (RAL 7035)
- Lockable front door with safety glass and swivel handle lock
- Door can alternatively be opened to the left or right
- Side walls and rear wall can be removed and locked
- Max. mounting depth behind the front plate: 480mm
- Supplied with earthing set, 4 adjustable feet and set of 28 mounting screws

**RACK-42: 42RS**

**RACK-33: 33RS**

**RACK-21: 21RS**



Height in mm w/o feet, please add 16-45mm for feet.

Model	RACK-42	RACK-33	RACK-21
Max. load capacity at centr. weight concentration	300kg	300kg	300kg
Dimensions	600x1,988x600mm	600x1,588x600mm	600x1,055x600mm
Weight	93kg	78kg	59kg



**RACK-12W**

Order No. 24.4520

**RACK-6W**

Order No. 24.4540



**Wall-mounted housings for 482mm (19") units**

- Sheet steel version
- Light grey powder coating (RAL 7035)
- Lockable front door with safety glass
- Door can alternatively be opened to the left or right
- Maximum mounting depth behind the front plate: 370mm
- Supplied with earthing set and set of 16 mounting screws

**RACK-12W: 12RS**

**RACK-6W: 6RS**

**RACK-12WP**

Order No. 24.4530

**RACK-6WP**

Order No. 24.4550



**Wall-mounted housings for 482mm (19") units, with movable middle part of the housing.**

- Sheet steel version
- Light grey powder coating (RAL 7035)
- Lockable front door with safety glass
- Door can alternatively be opened to the left or right
- Maximum mounting depth behind the front plate: 470mm
- Supplied with earthing set and set of 16 mounting screws

**RACK-12WP: 12RS**

**RACK-6WP: 6RS**

Model	RACK-12W	RACK-6W	RACK-12WP	RACK-6WP
Max. load capacity at centr. weight concentration	40kg	40kg	40kg	40kg
Dimensions	600x655x400mm	600x388x400mm	600x655x500mm	600x388x500mm
Weight	24kg	17kg	29kg	21kg



## RACK-20/SW

Order No. 24.8860



## RACK-12/SW

Order No. 24.8850



### Racks for 482mm (19") units

- Sheet steel
- Mat black textured coating
- Folding carrying handles
- 4 castors

RACK-20/SW: 20RS

RACK-12/SW: 12RS

## RACK-20GT/SW

Order No. 24.1100



## RACK-12GT/SW

Order No. 24.1090



### Racks for 482mm (19") units

- Lockable front door of tinted, shock-proof plexiglass
- Sheet steel
- Mat black textured coating
- Folding carrying handles
- 4 castors

RACK-20GT/SW: 20RS

RACK-12GT/SW: 12RS

Model	RACK-20/SW	RACK-12/SW	RACK-20GT/SW	RACK-12GT/SW
Max. load capacity at centr. weight concentration	80kg	65kg	80kg	65kg
Dimensions	548x1,055x435mm	548x700x435mm	675x1,150x500mm	675x725x500mm
Weight	18kg	12kg	24kg	20kg

## 482mm (19") Drawers

### Professional Quality.

- Mat black textured coating
- Steel housing
- Lock and recessed grip
- Supplied with 2 keys



Model	Order No.	Height (RS)	Inside dim. (WxHxD)	Outside dim. (WxHxD)	Weight
RCS-32/SW	33.3710	2	409x79x355mm	482x89x368mm	8.3kg
RCS-33/SW	33.3720	3	409x123x355mm	482x134x368mm	10.3kg

## 482mm (19") Drawers

### Standard quality.

- Mat black lacquered
- Steel housing
- Lock
- Supplied with 2 keys



Model	Order No.	Height (RS)	Inside dim. (WxHxD)	Outside dim. (WxHxD)	Weight
RCS-22/SW	33.4110	2	405x74x430mm	482x89x475mm	7.6kg
RCS-23/SW	33.4120	3	405x118x430mm	482x134x475mm	8.8kg
RCS-24/SW	33.4130	4	405x163x430mm	482x176x475mm	10.4kg

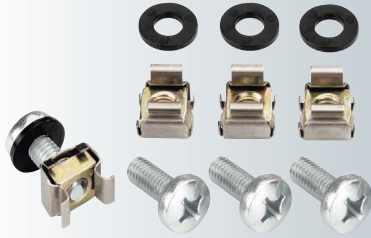

**MZF-8648**

Order No. 12.9410

**Set of cage nuts and screws**, matching rack rail MZF-8019.  
For mounting 482mm (19") inserts into racks and flight cases. The set consists of:  
4 x cage nut M6  
4 x Phillips head screw M6 x 15mm  
4 x plastic washer



**MZF-8646**

Order No. 12.6730

**Mounting set**, for mounting 482mm (19") units into racks and flight cases in any required height. The set consists of:  
12 x Phillips head screw M6 x 12mm  
12 x M6 nut  
12 x plastic washer



**MZF-8645**

Order No. 12.3500

**Set of cage nuts and screws**, for mounting 482mm (19") inserts into racks and flight cases. The set consists of:  
4 x cage nut M6  
4 x Phillips head screw M6 x 15mm  
4 x plastic washer

**482mm (19") Rack Panels**

Closed.

Of 1.5mm steel, black plastic coating. Upper and lower edges 8mm angled in different configurations. Ideally suited for the individual compilation of 482mm (19") systems.



Model	Order No.	Size (RS)	Width	Height
RCP-8701U	12.2760	1	483mm	44.5mm
RCP-8702U	12.2770	2	483mm	89mm
RCP-8703U	12.2780	3	483mm	132.5mm
RCP-8704U	12.2790	4	483mm	177mm

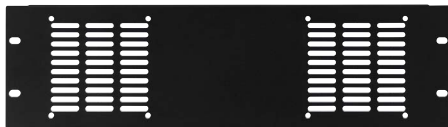

**RCP-8726U**

Order No. 11.1230



**Rack panel, 3RS**, for fan mounting.  
• Suitable for 2 fans, e.g. CF-220, CF-220BB, CF-1212  
• Ventilation slots  
• Dimensions: 483x133.5x8mm

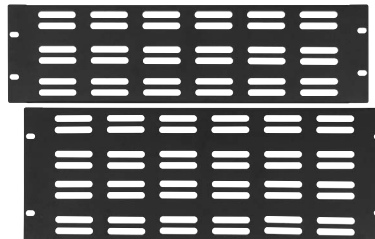

**RCP-8723U**

Order No. 11.0650



**RCP-8724U**

Order No. 11.0660



**Rack panels**, with ventilation slots.  
RCP-8723U: 3RS, 483x133.5mm  
RCP-8724U: 4RS, 483x178mm

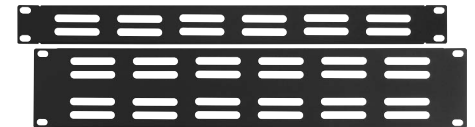

**RCP-8721U**

Order No. 12.2810



**RCP-8722U**

Order No. 12.2820



**Rack panels**, with ventilation slots.  
RCP-8721U: 1RS, 483x44.5mm  
RCP-8722U: 2RS, 483x89mm



**RCP-8713U**

Order No. 12.2910



**Rack panel, 1RS**  
• Punched holes:  
- 16 x 6.3mm jack  
• Dimensions: 482x44.5mm



**RCP-8715U**

Order No. 12.9940



**Rack panel, 1RS**  
• Punched holes:  
- 8 x 6.3mm jack  
- 8 x XLR jack (P series), e.g. NC-3FP1, NC-506/J  
• Dimensions: 482x44.5mm



**RCP-8719U**

Order No. 12.9960



**Rack panel, 1RS**  
• Punched holes:  
- 4 x D series, e.g. NC-3MDL1, NC-3FDL1, NL-2MP, NL-4MP  
- 8 x RCA jack, e.g. T-710GI  
- 1 x 3-pin IEC plug, e.g. AAC-150J  
• Dimensions: 482x44.5mm



## RCP-8730U

Order No. 12.9970



### Rack panel, 1RS

- Punched holes:
  - 4 x D series, e.g. NC-3MDL1, NC-3FDL1, NL-2MP, NL-4MP
- Dimensions: 482x44.5mm



## RCP-8731U

Order No. 12.9980



### Rack panel, 1RS

- Punched holes:
  - 6 x D series, e.g. NC-3MDL1, NC-3FDL1, NL-2MP, NL-4MP
- Dimensions: 482x44.5mm



## RCP-8732U

Order No. 12.9990



### Rack panel, 1RS

- Punched holes:
  - 8 x D series, e.g. NC-3MDL1, NC-3FDL1, NL-2MP, NL-4MP
- Dimensions: 482x44.5mm



## RCP-8733U

Order No. 12.0250



### Rack panel, 1RS

- Punched holes:
  - 4 x D series, e.g. NC-3MDL1, NC-3FDL1, NL-2MP, NL-4MP
  - 1 x 3-pin IEC plug, e.g. AAC-150J
- Dimensions: 482x44.5mm



## RCP-8734U

Order No. 12.0260



### Rack panel, 1RS

- Punched holes:
  - 8 x D series, e.g. NC-3MDL1, NC-3FDL1, NL-2MP, NL-4MP
  - 1 x 3-pin IEC plug, e.g. AAC-150J
- Dimensions: 482x44.5mm



## RCP-8736U

Order No. 12.3290



### Rack panel, 1RS

- Punched holes:
  - 4 x Speakon chassis connector (NLT series), e.g. NLT-4FP, NLT-4MP, NL-8MPR
- Dimensions: 482x44.5mm

Due to the different hole spacing at chassis connectors of the D and P series from NEUTRIK, a manual modification of the rack panels was necessary up to now in order to prevent a lopsided installation. This series of rack panels is particularly suitable for D-type and P-type connectors and is provided with the corresponding punched holes.



## MZF-312/SW

Order No. 12.8790

**Set of mounting screws**, for mounting chassis connectors into rack panels of the RCP-... series

The set consists of:

- 16 x recessed countersunk head screw M3 x 12mm
- 16 x nut M3 6K
- 16 x tooth lock washer
- 16 x washer



## DBA-1/SW

Order No. 11.0570



**Cover plate**, for rack panels. To cover punched holes which are unused, for XLR jacks of the D series.



## MFD-1

Order No. 11.1250



**Mounting frame**, with M3 thread.

- Suitable for chassis connectors of the standard D series
- For mounting with M3 screws (not supplied)

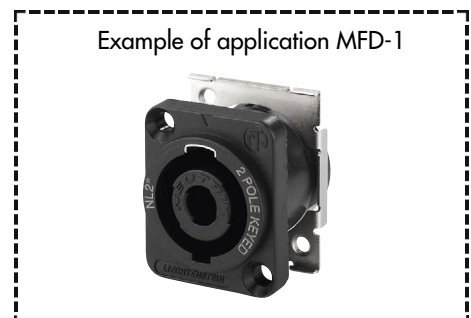





**RH-210**

Order No. 12.0350



**482mm (19") mounting plate, 2RS**

- Suitable for rack installation of units incapable of being installed into a rack (e.g. HiFi components)
- Version with various mounting holes
- Black lacquered steel version
- Support area: 375x440mm
- Max. load: 20kg

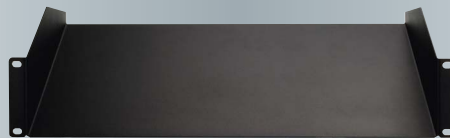

**RH-200**

Order No. 12.0320



**482mm (19") mounting plate, 2RS**

- Suitable for rack installation of units incapable of being installed into a rack (e.g. HiFi components)
- Black lacquered steel version
- Support area: 375x440mm
- Max. load: 20kg



**RH-110**

Order No. 12.0310



**482mm (19") mounting plate, 1RS**

- Suitable for rack installation of units incapable of being installed into a rack (e.g. HiFi components)
- Version with various mounting holes
- Black lacquered steel version
- Support area: 250x433mm
- Max. load: 8kg



**RH-100**

Order No. 12.0300



**482mm (19") mounting plate, 1RS**

- Suitable for rack installation of units incapable of being installed into a rack (e.g. HiFi components)
- Black lacquered steel version
- Support area: 250x436mm
- Max. load: 8kg



**RH-40**

Order No. 11.1180



**482mm (19") mounting tray, 4RS**

- Easy installation of units due to two adjustable supporting brackets
- Suitable for rack installation of units incapable of being installed into a rack (e.g. HiFi components)
- Black lacquered steel version
- Support area: 365x435mm
- Max. load: 10kg

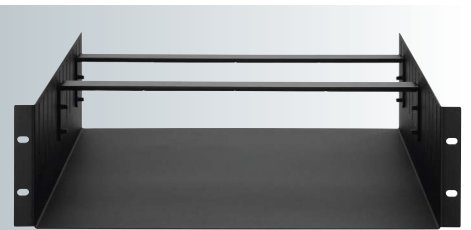

**RH-30**

Order No. 11.1170



**482mm (19") mounting tray, 3RS**

- Easy installation of units due to two adjustable supporting brackets
- Suitable for rack installation of units incapable of being installed into a rack (e.g. HiFi components)
- Black lacquered steel version
- Support area: 365x435mm
- Max. load: 10kg



**RH-20**

Order No. 11.1160



**482mm (19") mounting tray, 2RS**

- Easy installation of units due to two adjustable supporting brackets
- Suitable for rack installation of units incapable of being installed into a rack (e.g. HiFi components)
- Black lacquered steel version
- Support area: 365x435mm
- Max. load: 10kg

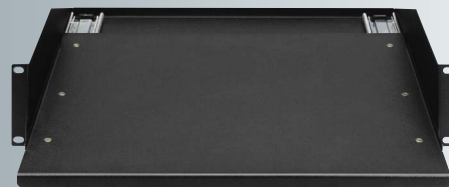

**RCB-2HE/SW**

Order No. 12.9090



**Pull-out mounting plate, for rack installation, 2RS.**

- Solid steel version
- Ball-bearing complete pull-out, max. load: up to 20kg
- Mat black textured coating
- Inside dimensions: 437x73x365mm
- Outside dimensions: 482x89x373mm

## MCS-180

Order No. 05.0002



**Rack-mount power strip**, with 8 earthed sockets.

- Sockets can be switched individually via illuminated switches
- Black sheet steel housing
- 1.8m connection cable with earthed plug
- Cable specification H05VV-F3G1.5mm<sup>2</sup>, 3,600VA max.
- Dimensions: 482x89x110mm, 2RS



## RCS-92/SW

Order No. 11.1410



**Rack-mount power strip**, with 9 earthed sockets.

- Sockets turned by 45°
- Black aluminium housing
- Removable mounting brackets
- 2m connection cable with earthed plug
- Cable specification: H05VV-F3G x 1.5mm<sup>2</sup>, 3,600VA max.
- Dimensions: 482x44x45mm, 1RS



## RCS-85/SW

Order No. 11.1850



**Rack-mount power strip**, with an illuminated main switch on the front and 8 earthed sockets on the back.

- Sockets turned by 45°
- Black aluminium housing
- Removable mounting brackets to allow for reversed mounting
- 2m connection cable with earthed plug
- Cable specification: H05VV-F3G x 1.5mm<sup>2</sup>, 3,600VA max.
- Dimensions: 482x44x52mm, 1RS

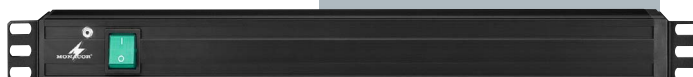

## RCS-82/SW

Order No. 11.1400



**Rack-mount power strip**, with 8 earthed sockets and illuminated main switch.

- Sockets turned by 45°
- Black aluminium housing
- Removable mounting brackets
- 2m connection cable with earthed plug
- Cable specification: H05VV-F3G x 1.5mm<sup>2</sup>, 3,600VA max.
- Dimensions: 482x44x45mm, 1RS



## RCS-18

Order No. 11.1200



**Rack-mount power strip**, with 8 earthed sockets and overvoltage protection.

- Child safety sockets
- Sockets turned by 45°
- Illuminated main switch
- Black plastic housing
- 1m connection cable with earthed plug, cable inlet can be turned by 90° via flexible joint
- Cable specification: H05VV-F3G x 1.0mm<sup>2</sup>, 3,600VA max.
- Dimensions: 482x44x60mm, 1RS



### Speaker Cables

The power in W of a 100 W amplifier arriving at the speaker, depending on the cable length and the cross section

Cable length	4 Ω Speaker					8 Ω Speaker					100 V Speaker system				
	Cable cross section in mm <sup>2</sup>					Cable cross section in mm <sup>2</sup>					Cable cross section in mm <sup>2</sup>				
	0.75	1	1.5	2.5	4	0.75	1	1.5	2.5	4	0.75	1	1.5	2.5	4
10 m	79.9	84.3	89.1	93.2	95.7	89.1	91.6	94.3	96.5	97.8	99.1	99.3	99.5	99.7	99.8
20 m	65.2	72.0	79.9	87.1	91.6	79.9	84.3	89.1	93.2	95.7	98.1	98.6	99.1	99.4	99.6
25 m	59.4	66.8	75.8	84.3	89.7	75.8	80.9	86.6	91.6	94.6	97.7	98.2	98.8	99.3	99.6
40 m	45.9	54.3	65.2	76.6	84.3	65.2	72.0	79.9	87.1	91.6	96.3	97.2	98.1	98.9	99.3
50 m	39.3	47.8	59.4	72.0	80.9	59.4	66.8	75.8	84.3	89.7	95.4	96.5	97.7	98.6	99.1
100 m	20.8	27.9	39.3	54.3	66.8	39.3	47.8	59.4	72.0	80.9	91.1	93.2	95.4	97.2	98.2
200 m	8.7	12.9	20.8	34.0	47.8	20.8	27.9	39.3	54.3	66.8	83.4	87.1	91.1	94.5	96.5
250 m	6.3	9.6	16.2	27.9	41.2	16.2	22.3	32.9	47.8	61.1	79.9	84.3	89.1	93.2	95.7
300 m	4.8	7.4	12.9	23.3	35.9	12.9	18.3	27.9	42.4	56.1	76.6	81.6	87.1	91.9	94.9
400 m	3.0	4.8	8.7	17.0	27.9	8.7	12.9	20.8	34.0	47.8	70.6	76.6	83.4	89.5	93.2
500 m	2.1	3.3	6.3	12.9	22.3	6.3	9.6	16.2	27.9	41.2	65.2	72.0	79.9	87.1	91.6
1,000 m	0.6	1.0	2.1	4.8	9.6	2.1	3.3	6.3	12.9	22.3	45.9	54.3	65.2	76.6	84.3

### Loss on Speaker Cables

Long cable distances can easily occur when planning and building more complex PA systems for which speakers are distributed in several rooms or at places covering greater distances. In this case, lengths of 100 m or 200 m between amplifier and speaker are no exception. In buildings like e.g. warehouses or places like e.g. sports facilities, this can quickly result in line lengths of 500 m or more.

With these cable lengths, great losses may occur along the cable runs. To understand why problems are possible and how to solve them, a little bit of theory is inevitable.

The resistance of a cable essentially depends on 3 factors: material, length and cross section.

The line length is double the cable length, as the way to the speaker and back to the amplifier determines the resistance of the line. Other influences like e.g. temperature and transition resistances at the places of contact have not been considered.

#### Example:

Supposing that an 8 Ω speaker system has to be connected to a power amplifier of 100 W output power. The cable length is 225 m at a cross section of 1 mm<sup>2</sup>. (These are model values and result in values in the model calculation which are easy to understand).

The resistance is calculated as follows:

$$R = \frac{l}{k \times A}$$

- R (Ω) = the resistance
- l (m) = total line length of the individual cores
- k = specific conductivity (kappa), this value is 56 for copper
- A (mm<sup>2</sup>) = cross section of the line

$$R = \frac{l}{k \times A} = \frac{450 \text{ m}}{56 \times 1 \text{ mm}^2} = 8 \Omega \text{ line resistance}$$

The amplifier supplies the following output values with 100 W at 8 Ω.

$$\begin{aligned} \text{Output voltage} &= 28.3 \text{ V} \\ \text{Output current} &= 3.53 \text{ A} \end{aligned}$$

Thus, the total resistance is composed of 8 Ω for the speaker system and 8 Ω for the speaker cable.

This means, that the load impedance at the amplifier is doubled and thus the output current is halved.

As the line resistance and the speaker impedance are of the same value in our example, only half the voltage is available at the speaker in this case.

Thus, only 25 W or 25 % of the possible amplifier power arrive at the speaker.

By using lines with a cross section of 4 mm<sup>2</sup> this value can certainly be raised to 44 %, however, this is generally not done as it is not costefficient.

If a 100 V system is used, the power output changes considerably. With 100 W output power, the load impedance of the speaker system is 100 Ω. The line resistance remains 8 Ω, it has a much minor influence on the total resistance in relation to the speaker impedance.

The calculation is as follows:  
The total current is

$$100 \text{ V} / (100 \Omega + 8 \Omega) = 926 \text{ mA}$$

The power on the speaker is

$$P = I^2 \times R = 0.926 \text{ A}^2 \times 100 \Omega = 85.75 \text{ W}$$

The power output is 85.75 W or 85.75 % and with the same line cross section it is thus considerably beyond that of low-impedance systems.

To obtain the same output in an 8 Ω system, a line cross section of 16 mm<sup>2</sup> would be required.

## Important Notes - please read very carefully!

All products of MONACOR INTERNATIONAL are tested continuously to ensure a constant quality level and to maintain quality standards. All products which are subject to the CE guidelines as well as the electric and electronic subassemblies which are subject to the directive for motor vehicles, are tested according to the respective standards and carry the CE mark. In consequence, these products can be sold in all EC countries without further tests or approvals.

### General Information

- All rights reserved by MONACOR INTERNATIONAL GmbH & Co. KG. All contents of this catalogue serve as information as to the products by MONACOR INTERNATIONAL only. No part of this catalogue including text, photos of products, graphics or any parts thereof may be reproduced in any form or by any means for any commercial use without our express prior written consent.
- \* Windows is a registered trademark of Microsoft Corporation in the United States and other countries.
- HDMI™ is registered trademark of HDMI Licensing L.L.C.
- We cannot be held responsible for printing errors, should they occur. We reserve the right to make technical changes without prior notice.
- The technical specifications stated are according to the information of the manufacturer.
- Due to production tolerances, technical data may vary slightly.
- Damage resulting from unauthorised servicing of the products thus causing changes, as well as improper handling resulting in consequential damage are excluded from the warranty. We will not be liable for changes of the state of the products resulting from improper storage, other interventions or improper use.
- If the units are interfered with, the CE approval will no longer apply. All products are always suitable for indoor use only unless stated otherwise. The products are not suitable for installations into aircrafts or surface mounting onto aircrafts.
- The products do not correspond to the medical products directive 2007/47/EC.
- If the products are to be put out of operation definitively, they must be taken to a local recycling plant for disposal which is not harmful to the environment.

### Technical Information

- Before first use of the products please read the instruction manual carefully!
- The products correspond to the directive for electromagnetic compatibility 2004/108/EC, the directive 2002/95/EC (RoHS) and where applicable to the low voltage directive 2006/95/EC with the directive 2009/125/EC (ErP).
- When operating with voltages of over 42 V, please always observe the respective safety measures.
- Before opening any products operated with 230 V mains voltage, disconnect the products from the supply voltage!
- Make sure that the supply voltage is disconnected before working on components and modules. Existing capacitors must be discharged.
- Mains cables and test cables have to be examined for damage regularly. Never pull on the cable to disconnect the plug from the socket.
- Mains cables and fuses must only be replaced by skilled personnel.
- Unless otherwise stated:
  - protect the products from humidity and heat,
  - always observe the admissible ambient temperature of 0-40 °C.
- Do not use a very high volume level when using headphones. Permanent high volume may damage your hearing!
- A soldering process which is too long and too hot may cause damage to the corresponding products. Choose a soldering temperature that is suitable for the material used. No liability can be assumed for damage to the product or consequential damage caused by improper handling.
- The plugs, jacks, switches rotary switches and potentiometers shown in this catalogue are only suitable for connection to safety extra low voltage (SELV) or signal voltage unless the item is designed for a higher voltage (see text or table).
- If the fixing nuts of chassis jacks or chassis plugs are overtightened, this may cause damage to the whole component. In case of improper handling, no liability can be assumed for this or consequential damage.
- The heat must be eliminated by air circulation. Therefore, do not cover ventilation slots with anything. Do not put or drop anything through the ventilation slots. Otherwise, there will be danger of an electric shock.
- Only use a dry, soft cloth for cleaning the products. Chemicals must not be used in any case.

### Information on the German Product Liability Act

According to the law dated 15 December 1989 governing product liability which was last amended by the law dated 19 July 2002, manufacturers, importers and dealers are obliged to compensate for damage caused by a faulty product under certain prerequisites.

A product can already be considered faulty if its presentation leaves a private, non-commercial end user with a wrong impression as to its safety in use or if it is to be expected that the private end user will not observe the required safety regulations when using the product or will apply an excessive operating voltage to it, except if this user has been informed as to the necessity to observe the safety regulations and specified voltages, etc.

In your own interest and for your customers' safety, therefore please draw your non-commercial customers' attention to the following:

The products listed in this catalogue may only be used for the stated purpose.

If there are any doubts as to the purpose of the goods, questions must be clarified with an authorised expert or with the service department of MONACOR INTERNATIONAL.

The following EN standards and VDE (Verband Deutscher Elektrotechniker = Association of German Electrical Engineers) regulations must be observed:

### Electromagnetic compatibility:

EN300422, EN301489, EN55013, EN55020, EN61000-3-2, EN61000-3-3, EN61000-6-1, EN61000-6-3

### Low voltage directive:

DIN VDE0100, DIN VDE0532, EN60065, EN60742, EN60570, EN60335, EN60598, EN60950, EN61010

### Motor vehicles directive:

directive 72/245EC, changed by the directive 2004/104/EC

### In Germany, the above-mentioned regulations can be obtained from:

VDE-Verlag GmbH

Bismarckstraße 33

10625 Berlin - Germany

Phone: +49 (0) 30 / 348001-0

Fax: +49 (0) 30 / 3417093

VDE-Verlag GmbH

Merianstraße 29

63069 Offenbach - Germany

Phone: +49 (0) 69 / 840006-0

Fax: +49 (0) 69 / 84000655

### Notes Regarding the Approval of Wireless Systems

The wireless microphone systems in the frequency range 863 MHz to 865 MHz are generally approved and licence-free!

### These systems are licence-free in the EU!

Every wireless system has been examined by a notified body and has been approved in the EU according to the R+TTE directive. However, a frequency assignment for the systems in the frequency range 175 MHz to 223 MHz, 672 MHz to 697 MHz, 740 MHz to 767 MHz and 790 MHz to 814 MHz for the corresponding area in which the unit is to be used must be applied for at the respective national authority.

### These systems require a licence in the EU!

In Germany, a licence-free operation of wireless microphones in the frequency range 790 MHz to 814 MHz (see directive 91/2005) is possible until 31 December 2015.

From 2016 on, the frequency range 790 MHz to 814 MHz can still be used with a frequency assignment. This assignment is subject to a fee.

In Germany, the frequency assignment has to be applied for at the corresponding branch of the Federal Network Agency (BNetzA, Germany).

The declaration of conformity can be found on our website:

[www.imgstageline.de](http://www.imgstageline.de).

The forms for the frequency assignment as well as the ruling 91/2005 can be found on the website of the Federal Network Agency

[www.bundesnetzagentur.de](http://www.bundesnetzagentur.de).

For countries outside of Europe, please consult the authorities of the corresponding country.

**Please observe the notes in the operating instructions!**